

DATA MANAGEMENT SOFTWARE

MEASURED DATA ACQUISITION,
DATA ANALYSIS, ENERGY
MONITORING AND AUTOMATIC
REPORTING

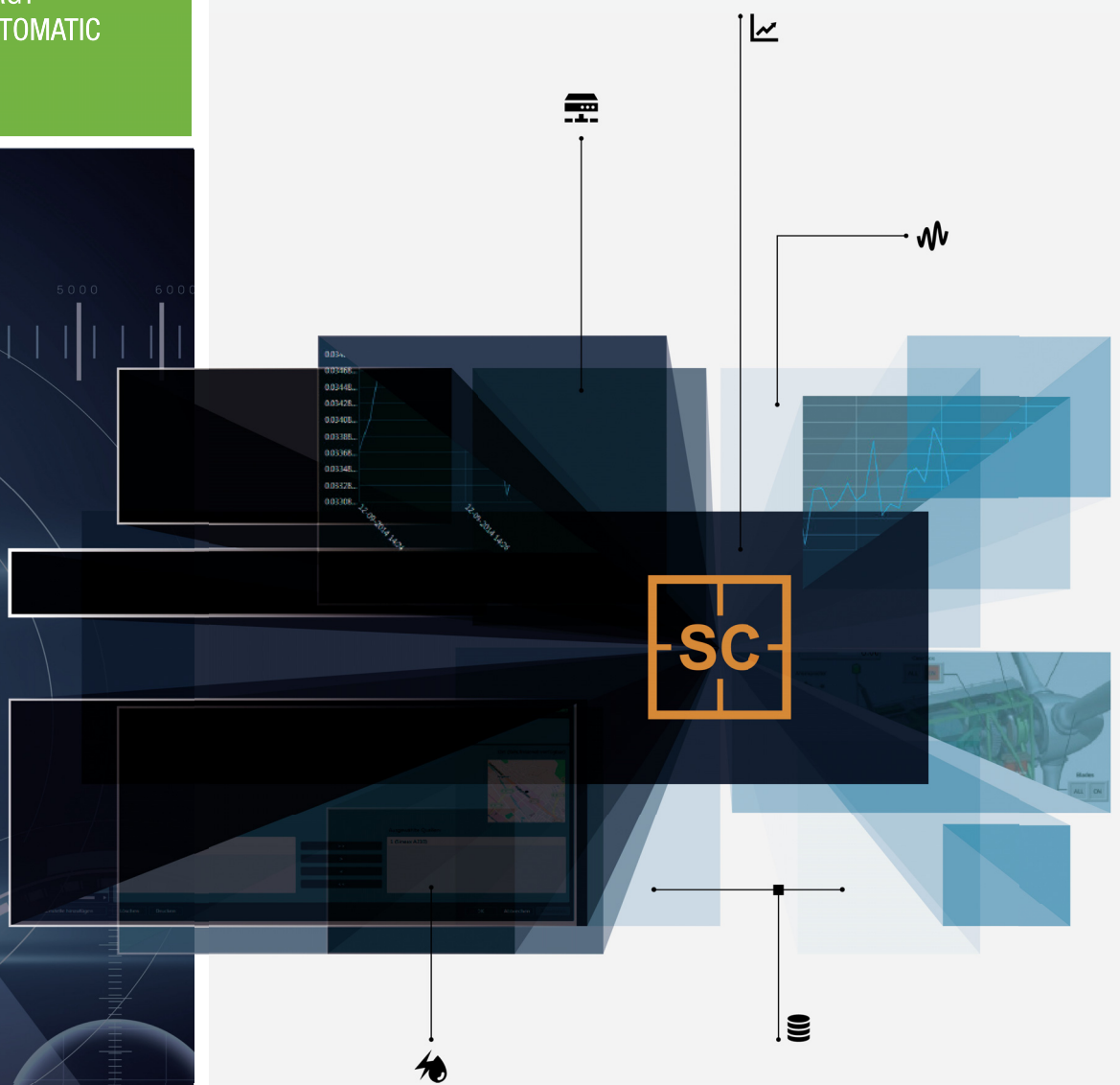

Table of Contents

1.	Introducing SmartCollect	3
2.	How SmartCollect works	4
3.	Installation	5-6
4.	Configuration	7
4.1.	User Account Control	7
4.2.	Activating Licenses	7-9
5.	SmartCollect Client	10-12
5.1.	Overview	12-14
5.1.1.	Groups	14-15
5.1.2.	Devices	15-20
5.1.3.	Channels	20-22
5.1.4.	Add Device Wizard	22-28
5.2.	Energy Management	28-30
5.2.1.	Print Consumption Reports	30-32
5.2.2.	Schedule Energy Consumption	32-33
5.3.	Power Quality	33-34
5.3.1.	Adding a power quality device	34-36
5.3.2.	Cyclic Data	36-37
5.3.3.	Cyclic Data Toolbar	37-41
5.3.4.	Power Quality Reports	41
5.3.5.	Power Quality Events	41-42
5.3.5.1.	Power Quality 10 ms recordings	42-44
5.3.5.2.	Power Quality Scope	44-45
5.3.6.	Power Quality Data Im/Export	45-46
5.4.	Scada	46
5.4.1.	Administer Scada Screens	46-48
5.4.2.	Designing Scada Screens	48-49
5.4.3.	Design Controls	49
5.4.3.1.	Date and time control	49-51
5.4.3.2.	Graph control	51-53
5.4.3.3.	Hotspot control	53-54
5.4.3.4.	Image control	55
5.4.3.5.	Level indicator control	55-57
5.4.3.6.	Numeric display control	57-59
5.4.3.7.	Push button control	59-60
5.4.3.8.	Radial gauge control	60-61

5.4.3.9. State led control	62-63
5.4.3.10. Electrical switch control	63-64
5.4.3.11. Text element control	64-65
5.4.3.12. Toggle switch control	65-66
5.4.3.13. Value display control	66-68
5.4.4. Scada List	68-70
5.4.5. Scada Graph	70-72
5.5. Tools	72
5.5.1. Services	72-73
5.5.2. Logging	73-74
5.5.3. Job Maintenance	74-75
5.6. Settings	75
5.6.1. Parameters	75-77
5.6.2. Serial Ports	77-78
5.6.3. Licenses	78-80
6. SmartCollect Configurator	81-85
7. SmartCollect Service	86
7.1. Service Security	86-87
8. SmartCollect Scada Runtime Client	88-89
9. SmartCollect Jobs	90
10. Troubleshooting	91
10.1. Underlying Provider Failed	91
10.2. Service Start Fails	91-92
10.3. Modbus Slave Exception	92
10.4. Using SmartCollect Trace	92-93
10.5. Services Access Denied	93
11. Index	94-95
12. Copyright Notice	96

1 Introducing SmartCollect

SmartCollect can be used to collect data / values from Camille Bauer Metrawatt and Gossen Metrawatt devices and, via Modbus protocol (RTU/TCP) or OPC servers, also third party devices. The recorded values are all stored in a central database, not encrypted or blocked and accessible for external applications that wants to use this data. At the moment the following devices are supported:

- Camille Bauer *APlus*
- Camille Bauer Linax A305
- Camille Bauer Kinax HW730
- Camille Bauer Sineax A210, A220, A230, A230s
- Camille Bauer Sineax CAM, DM5F, DM5S
- Camille Bauer Sineax V604S, VB604S, VC604S, VQ604S
- Gossen Metrawatt A2000
- Gossen Metrawatt Smartcontrols U200, U300
- Gossen Metrawatt U1600, U1601, U1602, U1603
- Gossen Metrawatt Compact Line U181, U187, U189
- Generic Modbus TCP devices
- Generic Modbus RTU devices
- OPC DA 2.0/3.0 servers

The application consists of 4 main components, the component that does the actual "work" is SmartCollect Service. A Windows service that always works in the background and reads the data of the different devices based on an adjustable interval.

Another component is the client application which can be used to configure devices and channels which have to be read, to visualize saved data or print and schedule reports

The third component is the SmartCollect Scheduler. This component is also a Windows service and it is responsible for the executing jobs at the scheduled time and to send the output to the user in PDF format.

The last component of the application is a command-line program with which a number of management tasks can be executed, either by the task manager or by hand through the command line.

During the development of the Windows service a lot of attention was paid to performance and to be able to recover from all kinds of error conditions by it self. By starting the service, a separate thread (SmartCollect has a multi-threading architecture) starts for every source that has to be read. In addition a "supervising or controller" thread is started to check constantly whether all other threads deliver their data in time. Whenever this doesn't happen, for whatever reason, the failing thread will be restarted. When this doesn't restore the communication, the application can, after retrying for an adjustable amount of attempts, send an email to a system administrator. However, this is only possible if the SMTP settings are configured within the SmartCollect parameters and the provided SMTP server is accessible.

2 How SmartCollect works

The basic task of SmartCollect is quite simple and using it isn't complicated also. However, during development a lot of attention was paid to performance, functional reliability and inherent auto-repair capabilities of the application. With the latter is meant that when a problem occurs in, for example, the communication with a source, the application will check this and will try to solve it. How this is realized is shown in the model below.

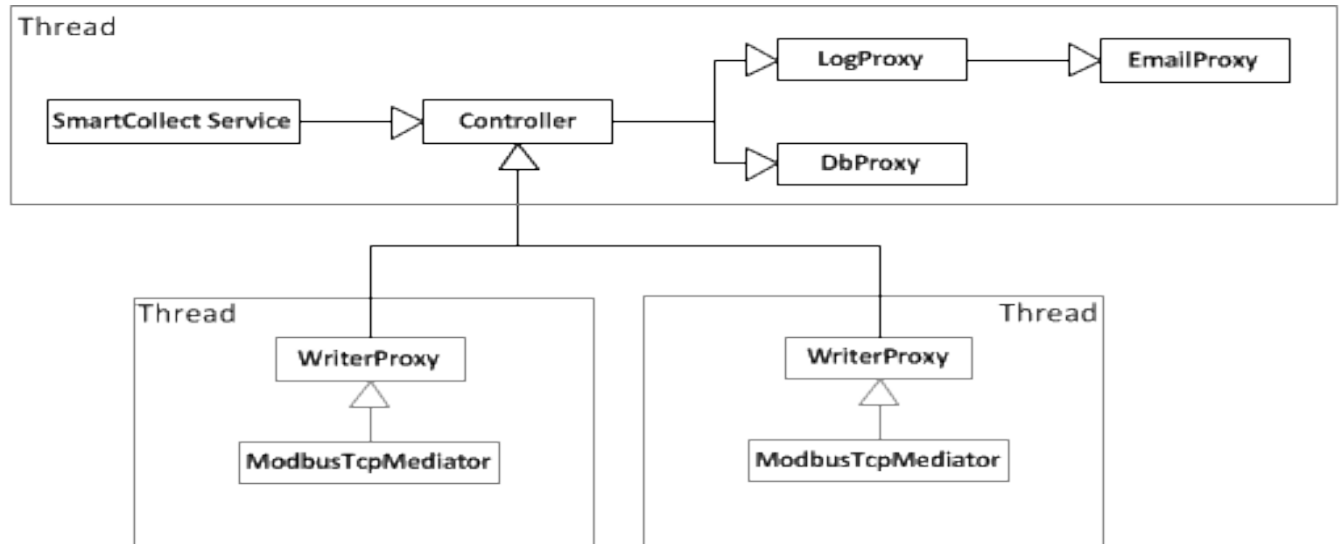

The model is a strongly simplified representation of SmartCollect's architecture. As you can see, the first thing the service starts is the "Controller". The Controller is a sub-process whose task it is to check the health of the other sub-processes and the various devices and take action if necessary. The Controller then starts the DbProxy which manages all database communications and the LogProxy which takes care of the logging and sending emails to the system administrator, if necessary.

When these overhead processes are up and running, for every source a new thread is started that takes care of the values of only that source. The term "source" refers to any kind of device from which data is read. In order to do so, the Controller starts a WriterProxy that makes sure that all sources look the same to the Controller. The WriterProxy itself uses a certain type of mediator, depending on what is defined for each specific source. In the model above two Modbus TCP devices are being read.

When everything has started the Controller will check whether the various threads (i.e. the sources) deliver their data to the DbProxy at the correct time. If the Controller notices that this is not the case, the thread in question will be stopped and restarted after a configurable time. If the thread will still not deliver any data this process of stop and start will be repeated an adjustable number of times until data reappears. If all of this still won't give a result, the source in question will be terminated for one hour and the system administrator will be informed of this shortcoming by email and a error message in the state buttons on the main screen. After this period the Controller will restart the thread one time and will then wait another hour and repeats this until the system administrator disables the source itself within the client application or until data is read.

Performance tests proved the server impact to be low, despite of the overhead. During these tests 21 devices (i.e. sources) which contained 12 data channels respectively were read by Modbus TCP. When reading these 252 channels the maximum reachable interval proved to be 3 seconds, which means that every hour 302.400 values (7,2 million every day) are registered in the database. During this test the average CPU load of the service was about 2-3%. The bottleneck during this test, because of which a speed under 3 seconds was not possible, was the speed with which the sources could deliver the data. However, because hardware will becoming faster, it is most likely that with new devices an even higher speed of reading data will be possible. Furthermore this test configuration is now running for several years without any problems, therefore proving that this speed is obtainable in practice.

The fastest interval that SmartCollect can use for reading devices depends heavily on the hardware capabilities and performance of the connected devices, the protocols used and the number of values read from a single device. For instance, if we would do the same test as above using Modbus RTU devices the fastest interval would probably be around 10 seconds since this way of communicating is much slower than Modbus TCP. Or when you want to read out all 1100 values of a single APlus the fastest interval will even be more then 10 seconds.

3 Installation

Installation prerequisites

Before you can install SmartCollect, a certain amount of prerequisites have to be met.

1. Microsoft .NET Framework 4.5.1 (if not already installed)
2. Microsoft SQL Server 2008 R2 or higher
3. OPC Core Components 2.00 (when OPC communication will be used)

First of all Microsoft .NET Framework 4.5.1 has to be installed. For this you can check programs and features in the control panel of Windows if it is already installed or not. If this is not the case, you first have to install Microsoft .NET Framework 4.0. You can download this by clicking on [this](#) Url.

 To check if .NET Framework 4.5.1 is installed or not you can also start the SmartCollect installer. The installer will check this as well and give you an error message when the correct .NET Framework version is missing.

The second condition that has to be met is that a suitable database server has to be available within the accessible network. This has to be Microsoft SQL Server 2008 R2 or higher. It is no problem to use the Express edition except that the database can not grow beyond the 10 GB since this is the limitation of the Express edition.

The third condition is that the OPC Core Components 2.00 have to be installed. There is a installable version available on the delivered installation medium.

Installation procedure

To start the installation you have to use the "SmartCollect<<version number>>.msi" from the installation medium. After starting the setup, a welcoming screen is shown which indicates what will be installed. Click in this screen on "Next" to continue to the End-User License Agreement (EULA) screen. You have to accept the EULA to be able to continue the installation. If you can't agree to this agreement, please contact your sales representative.

After you accept the EULA and clicked on "Next", the screen below is shown.

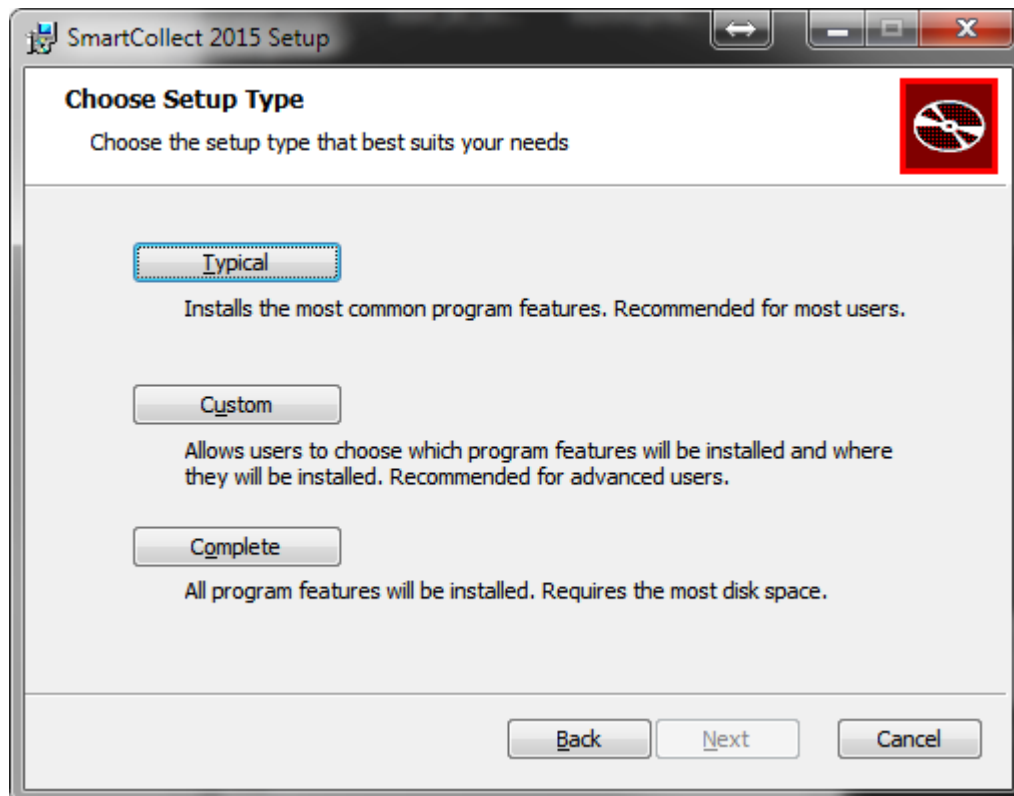

Here you can choose the installation type. "Typical" will install the SmartCollect Client with the "Energy Management" module and the SmartCollect Service. The option "Complete" will install every available component and module and with the "Custom" option you can choose what to install and where.

 If a module is available in the application also depends on your license. If a module is not licensed, installing this module will not give a access to it.

When you click "Custom" the following screen is shown.

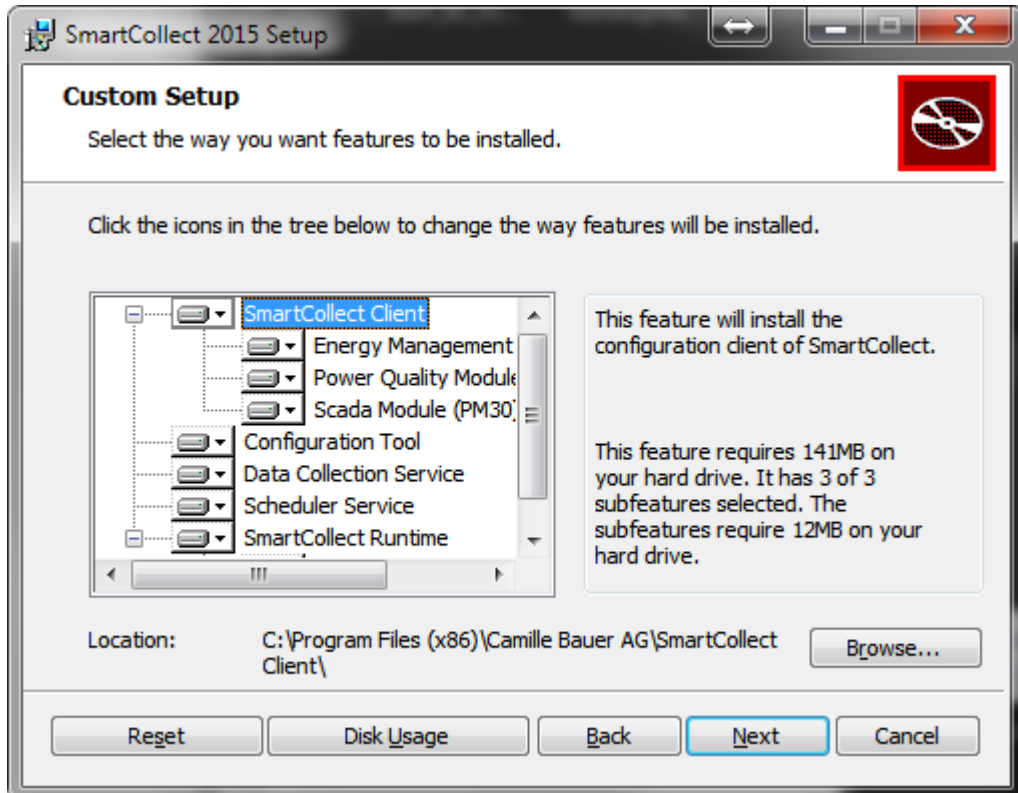

In "Custom" you can choose exactly which components to install and where they are installed. The installation option "SmartCollect Client" has sub features to choose from (in this version only "Energy Management" and "Scada" are available but that depends on the version you have). When you click on one of the button in front of an feature, you will get a dropdown list like below.

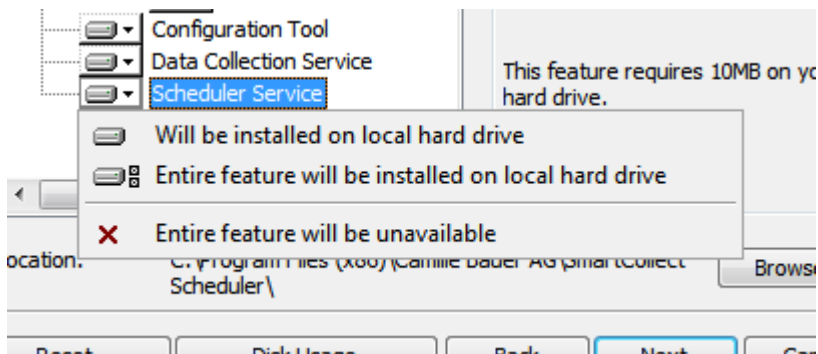

With this dropdown you can choose to install the feature or not.

With the button "Browse" you can set a directory for every feature separately. This means you can, for example, install the client on drive D and the service on drive C.

After clicking "Next" the last screen before the installation start is shown. When you click "Install" in this screen the installation starts. A progress bar will give you an indication of the progress of the installation.

After the installation, and if not blocked by security restriction, the SmartCollect Configurator is automatically started to allow you to configure the application. See "**Configuration (Section 4)**" for more information about this.

⚠ Do not start the installed application just yet, first read the chapter "Configuration". The reason for this is that when you start SmartCollect for the first time, it will try to generate the database. If you start SmartCollect using the wrong configuration you may end up with a database at a location where you don't want it to be.

4 Configuration

After having installed SmartCollect take your time to set up a proper configuration. The configuration process exists of a number of steps (which can be looked up in detail in subsequent sections):

- **Configure the application (Section 6)**
- **Activate the licenses (Section 4.2)**
- **Configure the services (Section 7) and configure security (Section 7.1)**
- **Configure the devices (Section 5.1.2)**

4.1 User Account Control

In Windows version that make use of "User Account Control", some tasks that require administrator privileges can be blocked although your account has the necessary privileges.

Below you see a screenshot of this setting.

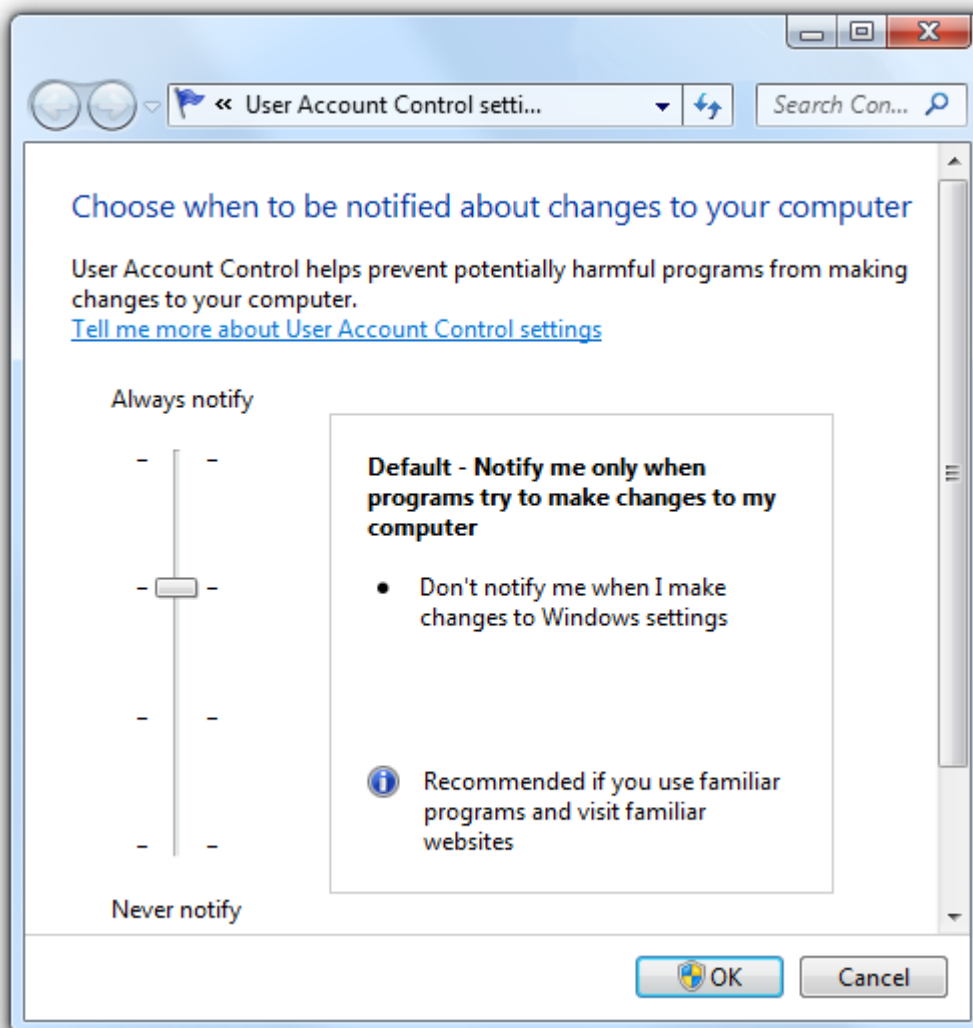

When you have this setting turned on you will not be able (for example) to start and stop the SmartCollect service from within the client application. To solve this you can either disable "User Account Control" by setting the slider all the way down or by explicitly choose the run the SmartCollect client as an administrator.

4.2 Activating Licenses

The second step of the configuration is activating the licenses. For this you need the 2 activation codes you have received from Camille Bauer Metrawatt AG (CBM): One activation code for the client application and one for the SmartCollect service.

 If you just want to try out SmartCollect you can skip this section and you can use SmartCollect and all of its functions for 30 days.

 For the activation process internet traffic via port 80 is necessary. To check if this is possible you can for example open Microsoft Internet Explorer (or any other Web Browser) and go to the site www.google.nl. If the search page is shown, internet traffic via port 80 is allowed and the activation process will be able to communicate normally with the license server.

Both licenses will be activated through the client application, to do so, go to "Settings" and then "Licenses" and a screen is shown where you have several options regarding license management.

Now click on "Activate new client license" and the activation wizard's welcome screen will appear. Click "Next" and the screen below will be shown.

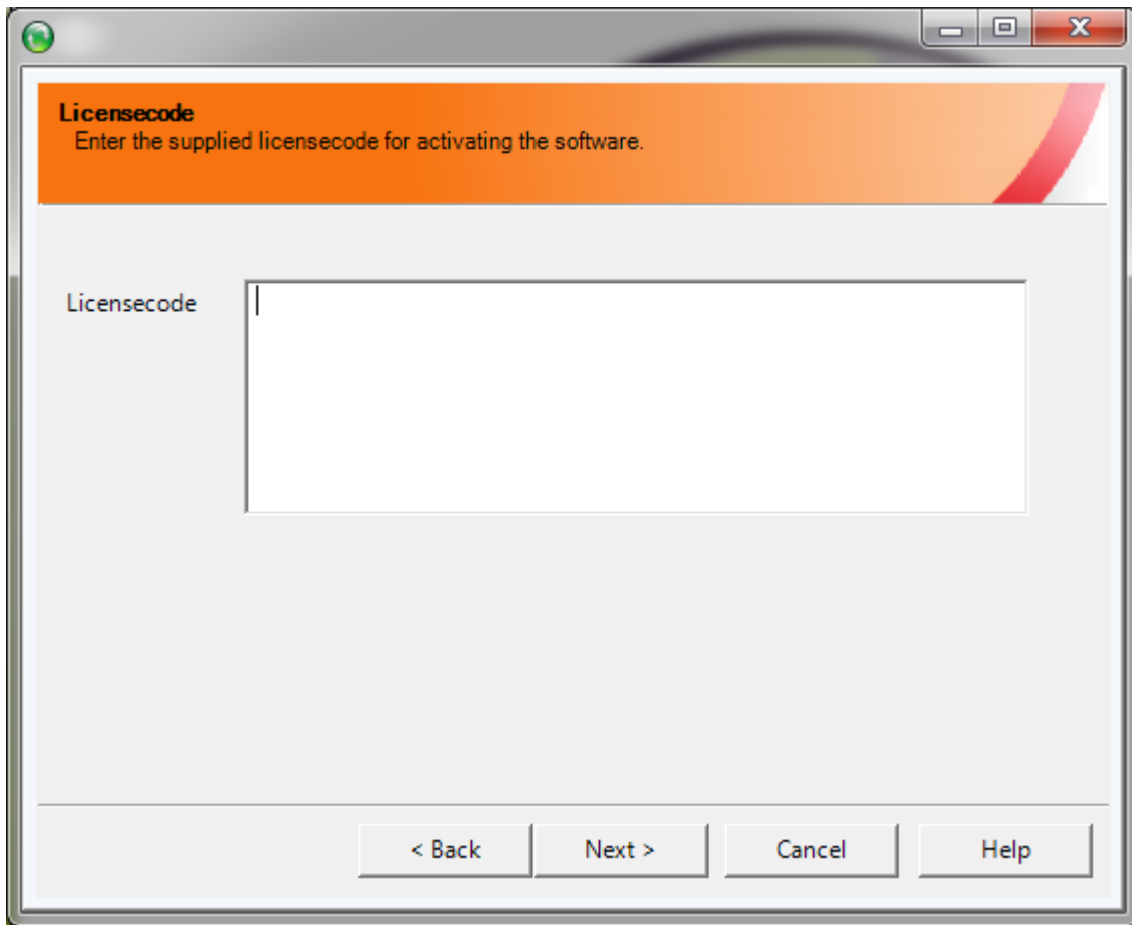

The screenshot shows a software window titled "Licensecode". The window has a standard Windows-style title bar with minimize, maximize, and close buttons. The main content area features an orange header bar with the text "Licensecode" and "Enter the supplied licensecode for activating the software." Below the header is a large, empty text input field with the label "Licensecode" to its left. At the bottom of the window, there are four buttons: "< Back", "Next >", "Cancel", and "Help".

In this screen you have to enter the activation code you have received from CBM and then you click on "Next" again and the code will be checked and the result will be shown in the next screen.

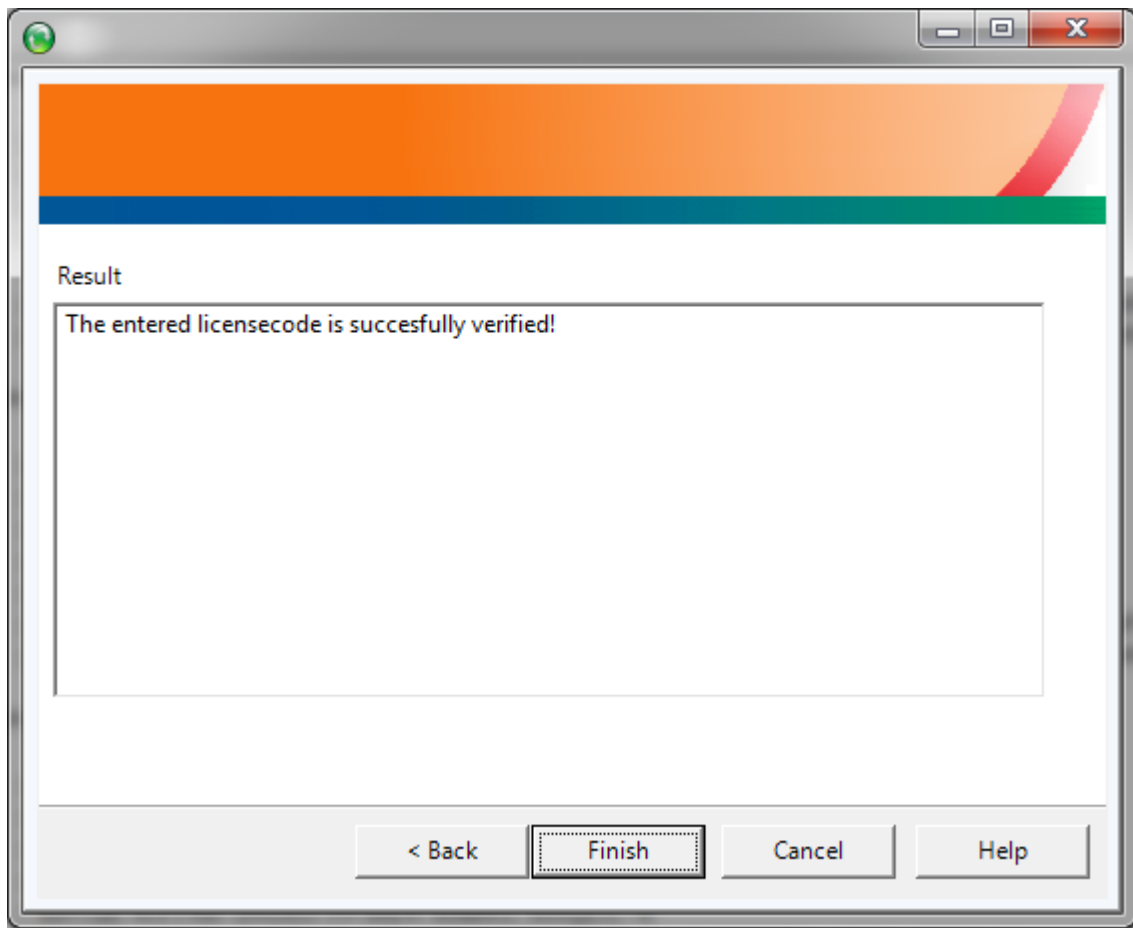

With a positive result the button "Finish" will be activated and you may close the wizard. If you haven't changed the setting "ClientLicenseFile" in the Configurator, a license file "SmartCollect_Client.license" will be saved in the SmartCollect directory in ProgramData. By clicking on "Show client license information" you can view the license data.

For activating the service license you have to follow the same steps but you use the link "Activate new service license" instead.

5 Main Screen

The main screen of SmartCollect is shown below.

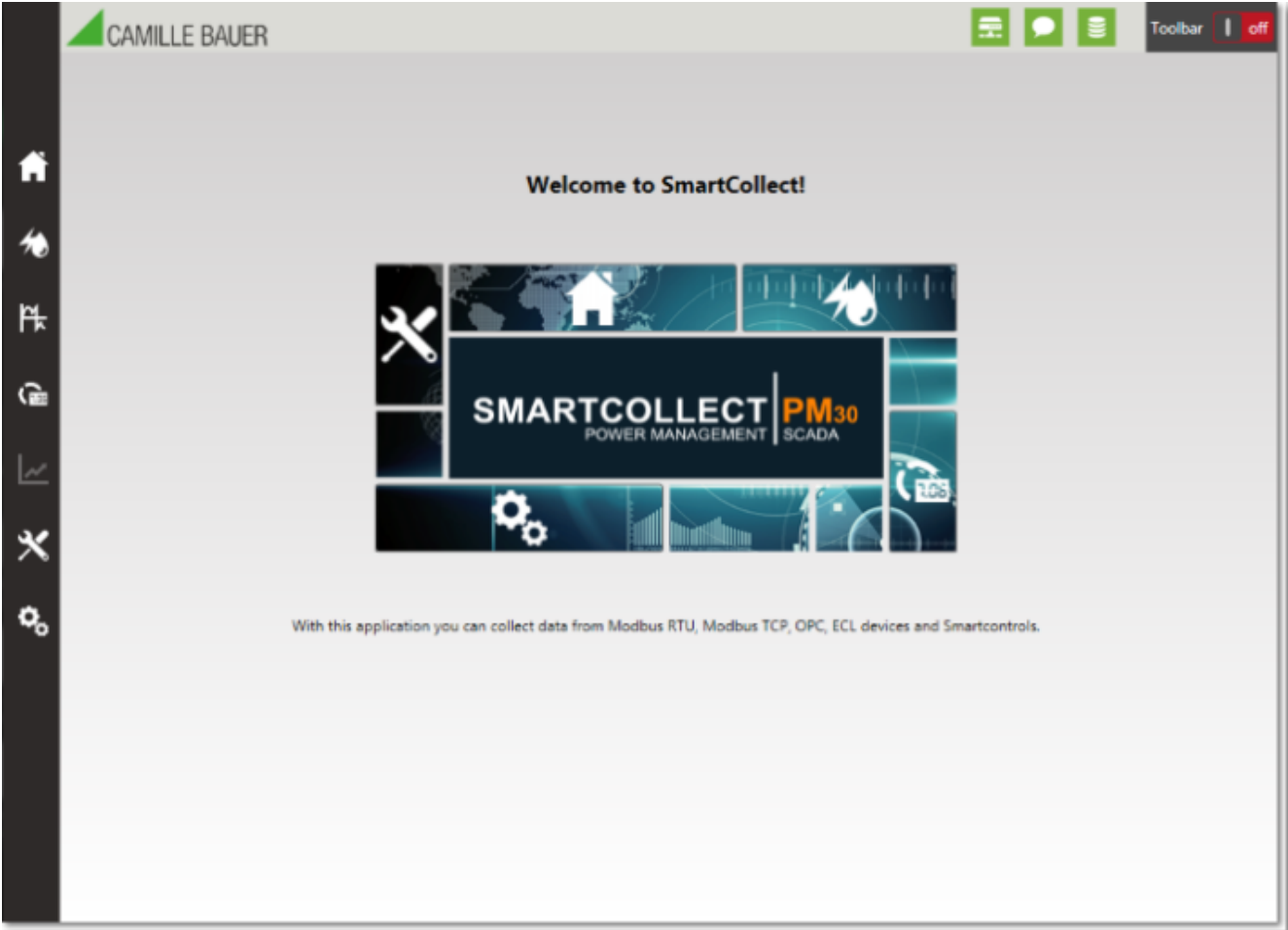

On the left of the screen you see the icons of the main menu. When you hover over it with your mouse it will expand showing you a description of the menu items and submenus when available.

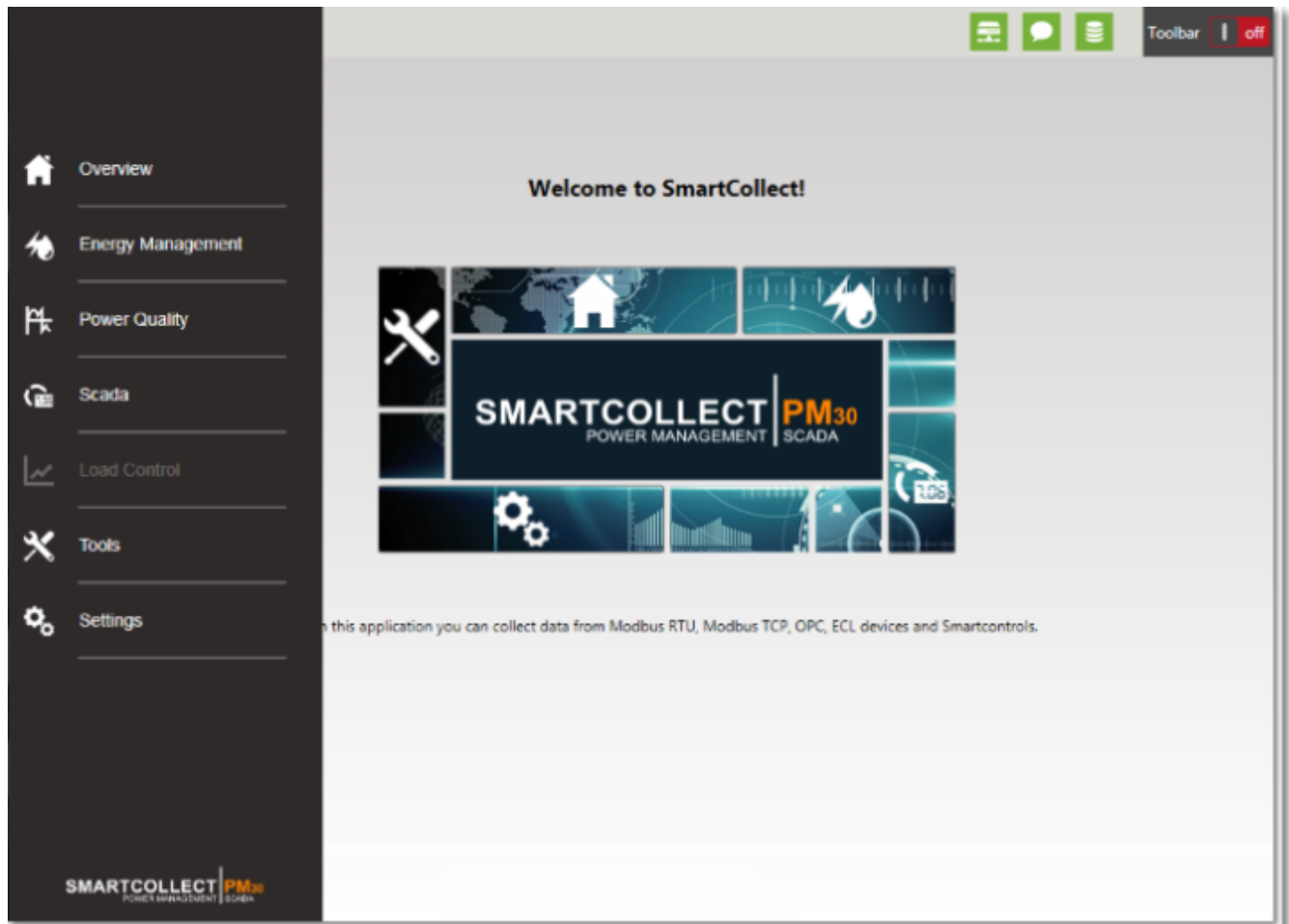

In the middle of the screen there are some shortcut buttons to the more used screens of SmartCollect.

Furthermore there are 3 state icons showing in the top right corner of the screen. From left to right:

1. System messages for all system related warnings and errors
2. communication messages for all device related warnings and errors
3. Database messages for all database related warnings and errors

The icons change color depending on the type of messages they contain. If an icon only contains warnings the color will turn orange and when it also contains error message it will turn red. This way it is very easy and quick to see if everything is functioning correctly.

When you click on one of them, a popup as shown with the description of the messages.

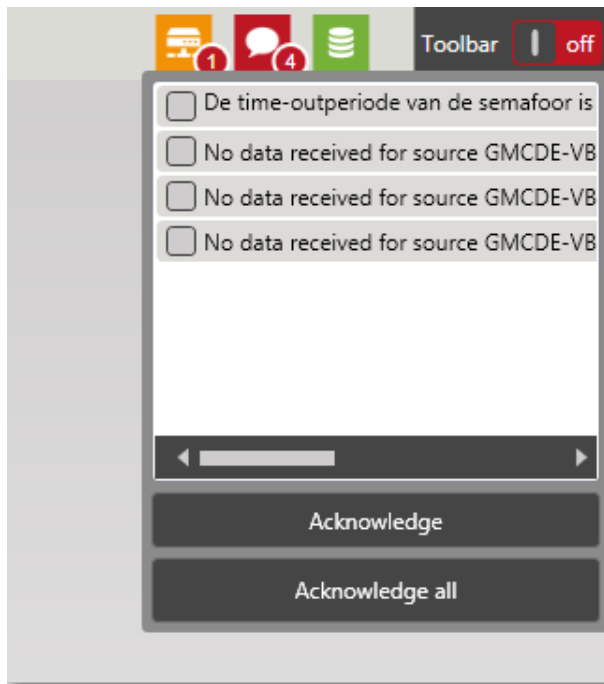

You can select a few messages, by clicking the checkbox in front of the message, and then click "Acknowledge" or you can just click "Acknowledge all" and the icon will return to its green color. When you acknowledge a message, your username and the date and time is written to the database.

The toolbar is discussed in a different part of this manual because the toolbar does not apply to the main screen and that is why it is switch off. If it is relevant in a screen it will automatically switch on unless you have switched it of in the past, since this is saved on a per user basis, then you have to manually switch it on again to show it for that particular screen again.

5.1 Overview

In "Overview" you can create groups and subgroups and configure the devices you intend to collect data from. Below you see an example of one main group with two subgroups.

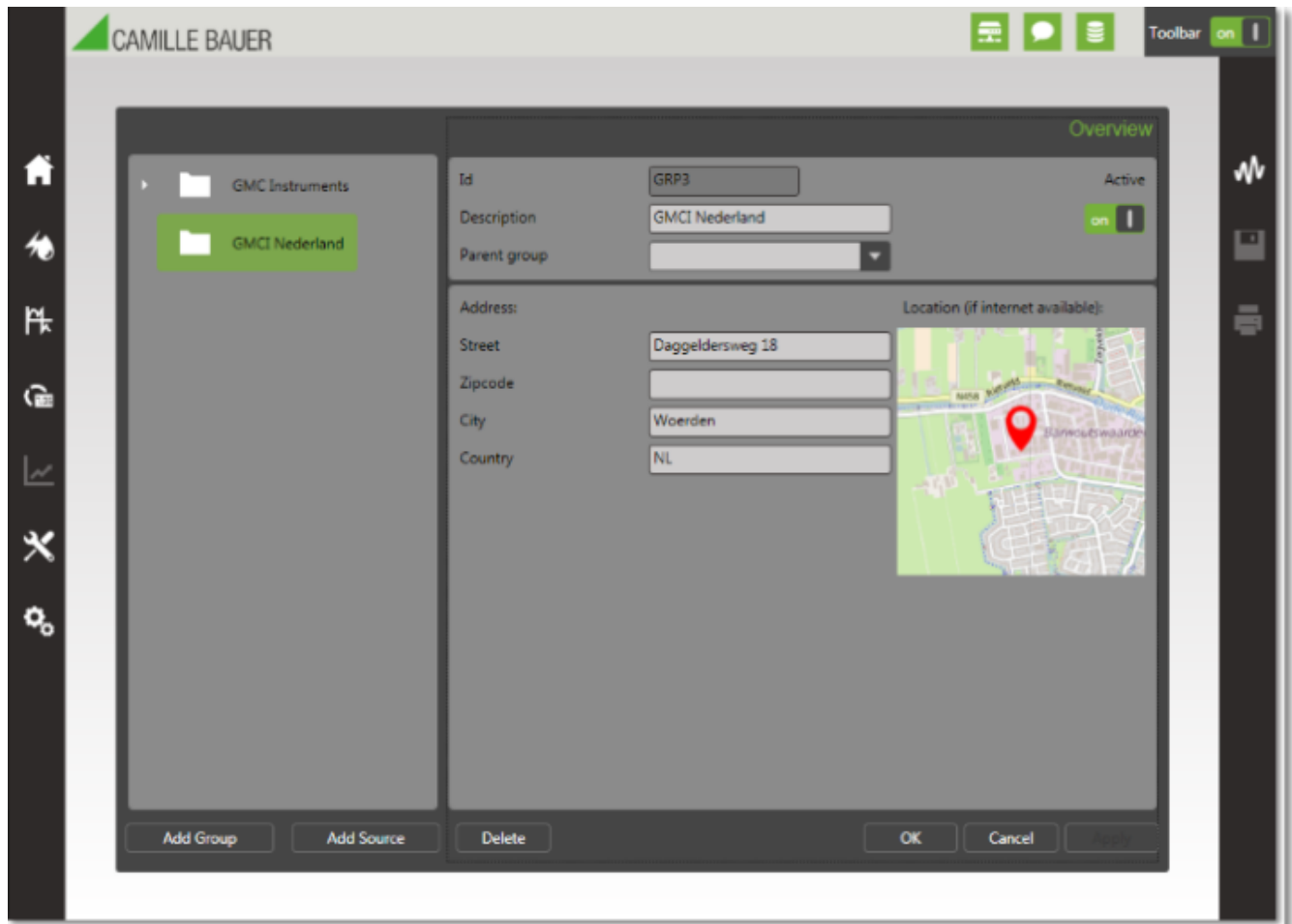

Before you can add devices you must have at least one group. When a group is selected you will have the option to add a device (discussed in a **separate topic (Section 5.1.2)**). You can add as many devices to a group as you want.

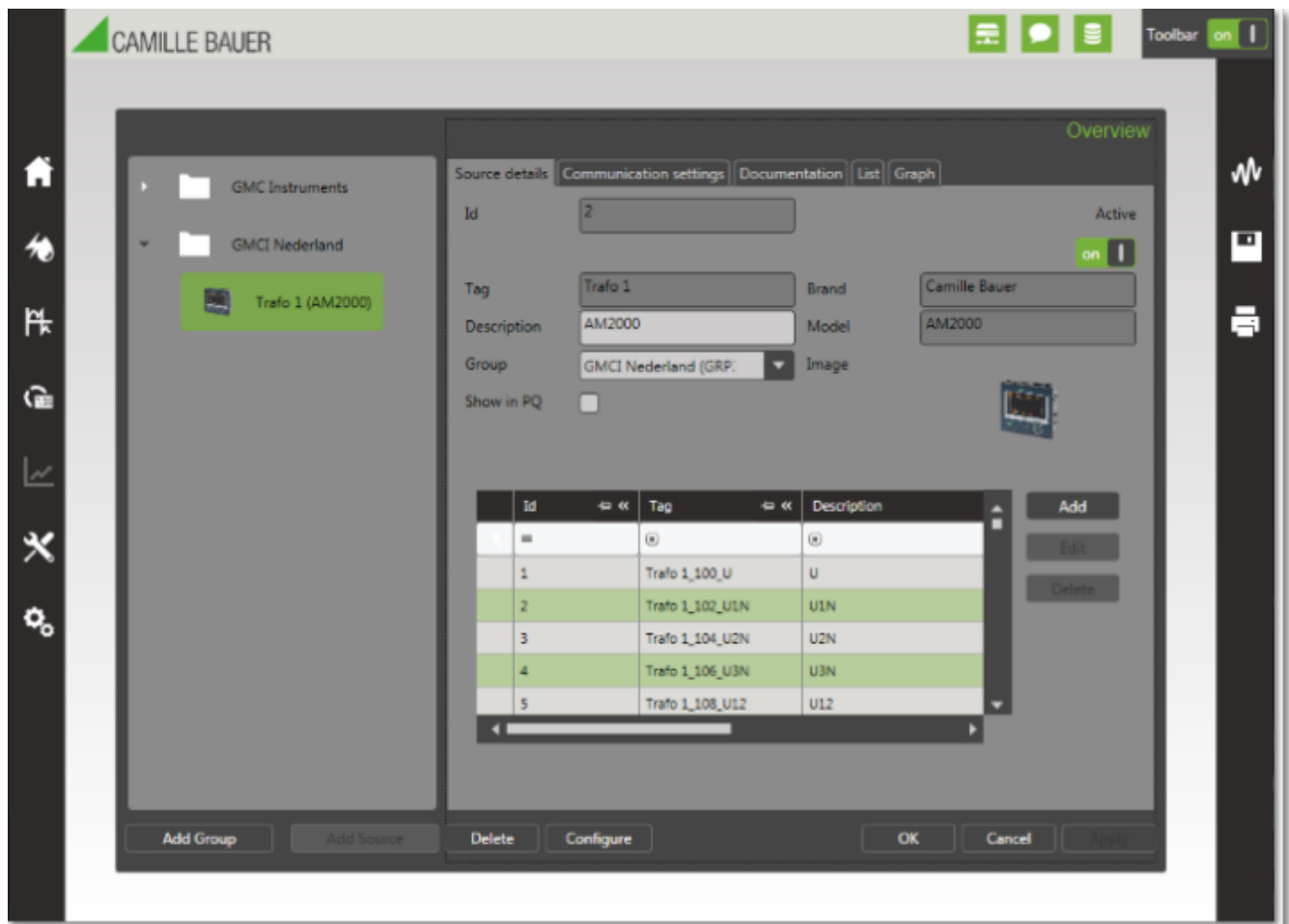

5.1.1 Groups

We recommend that the groups you create reflect the real-world layout of your devices, for example, a main group per building and a subgroup per floor or a main group per customer and a subgroup per building of the customer. This way you get a clear understanding of the location of devices. In SmartCollect's Energy Management module you are able to create cost centers that are a type of groups that can be used to group devices together for reporting energy consumptions.

When you want to add a group you just click on "Add group" and a new group with some default values is added and shown in the details screen. The first thing you should do is to change the default generated "Id" of the group to a more appropriate "Id" with a maximum length of 5 characters.

When you enter an address and you are connected to the internet the location is displayed on the map on the right hand side of the screen.

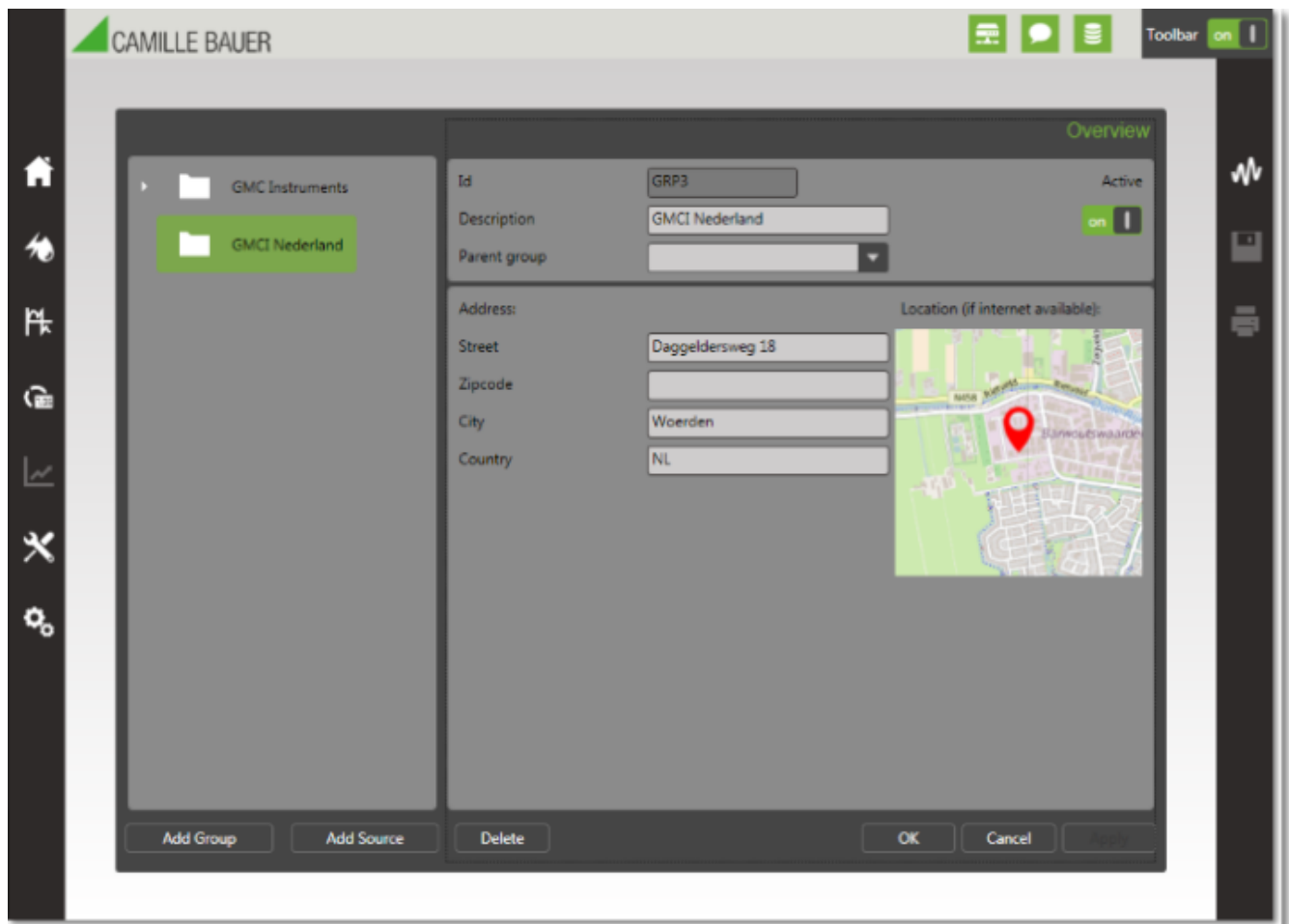

When you click "Apply" the group is saved and added to the tree view on the left.

The "Active" switch

With the "Active" switch you can deactivate the group, and all device which are part of that particular group, with a single click. There are 2 things important to be mentioned here, first: Nothing will happen until the SmartCollect Service is restarted (because the service only reads the configuration at startup time). Secondly: Although the devices added to this group can still have their own "Active" switch set to on, they will not be read out anymore.

5.1.2 Devices

In the "Overview" screen you can configure the devices that take part in the data collection of the service. To do this you select the group that the device should belong to and then click the "Add Source" button. This will bring you to a wizard that will guide you to the process of adding a device. The wizard is explained in detail in **this topic (Section 5.1.4)**.

Device details and channels

When you select a device in the left tree view the details screen of the device is shown.

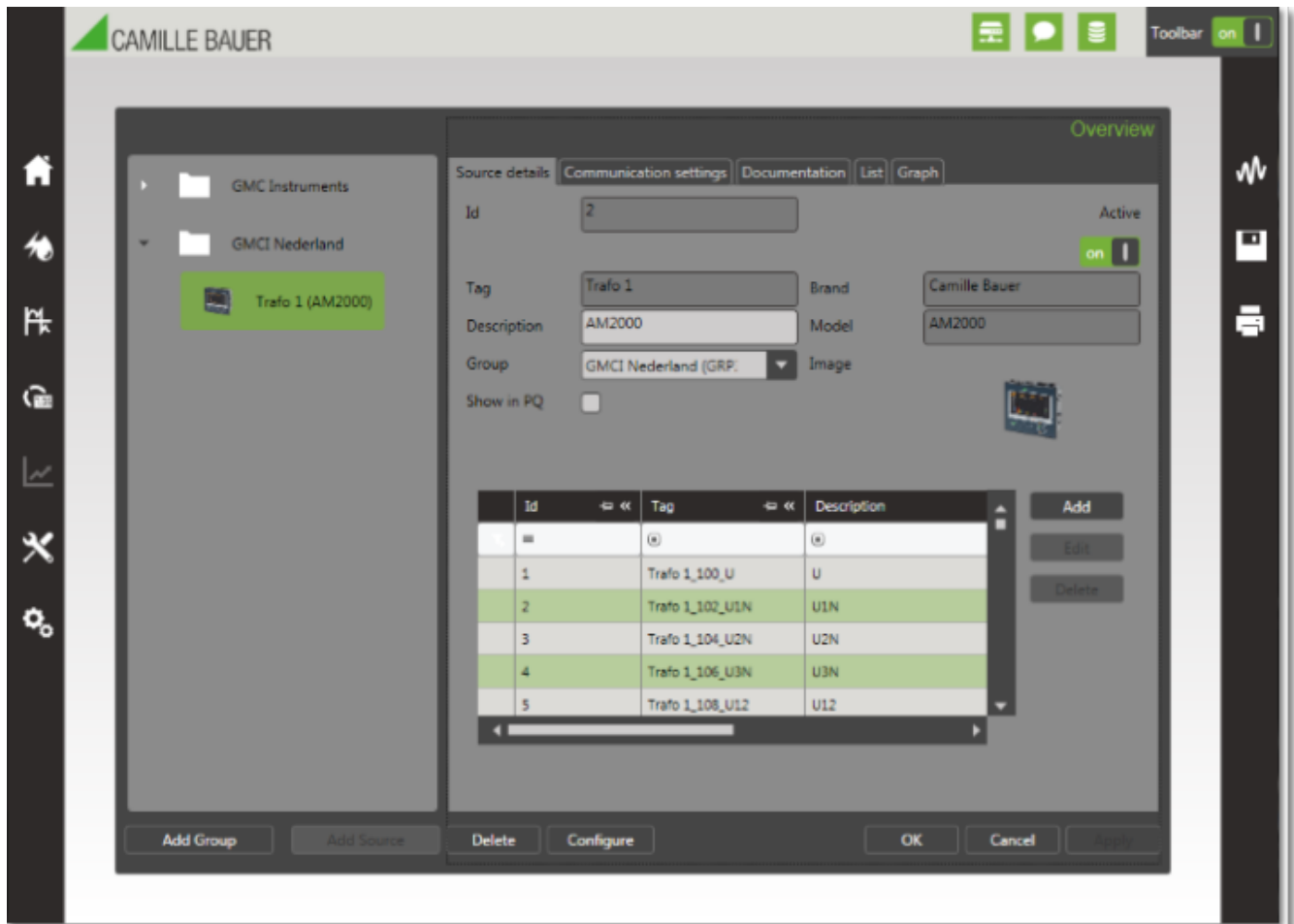

Here you see some basic information of the device and the configured **channels (Section 5.1.3)**. You can delete a source (and all configured channels with it) by clicking the "Delete" button. The values that were recorded will not be deleted from the database but can no longer be accessed through the client application. External applications connecting directly to the SmartCollect database will be able to access and use the data.

If you want to add channels you can do this manually as described **here (Section 5.1.3)** or you can click the "Configure" button. The "Configure" button will bring up the "Add new device" wizard but it will start at the step where you can select the channel groups. You can select new channels groups or individual channels in the wizard. The already configured channels will be selected in the wizard, however unselecting them in the wizard will not delete them from the configuration. The wizard will only add new selected channels and will never delete anything.

Device communication settings

On the second tab you can see the communication settings of the device. In the screenshot below the settings of a Modbus RTU device are shown.

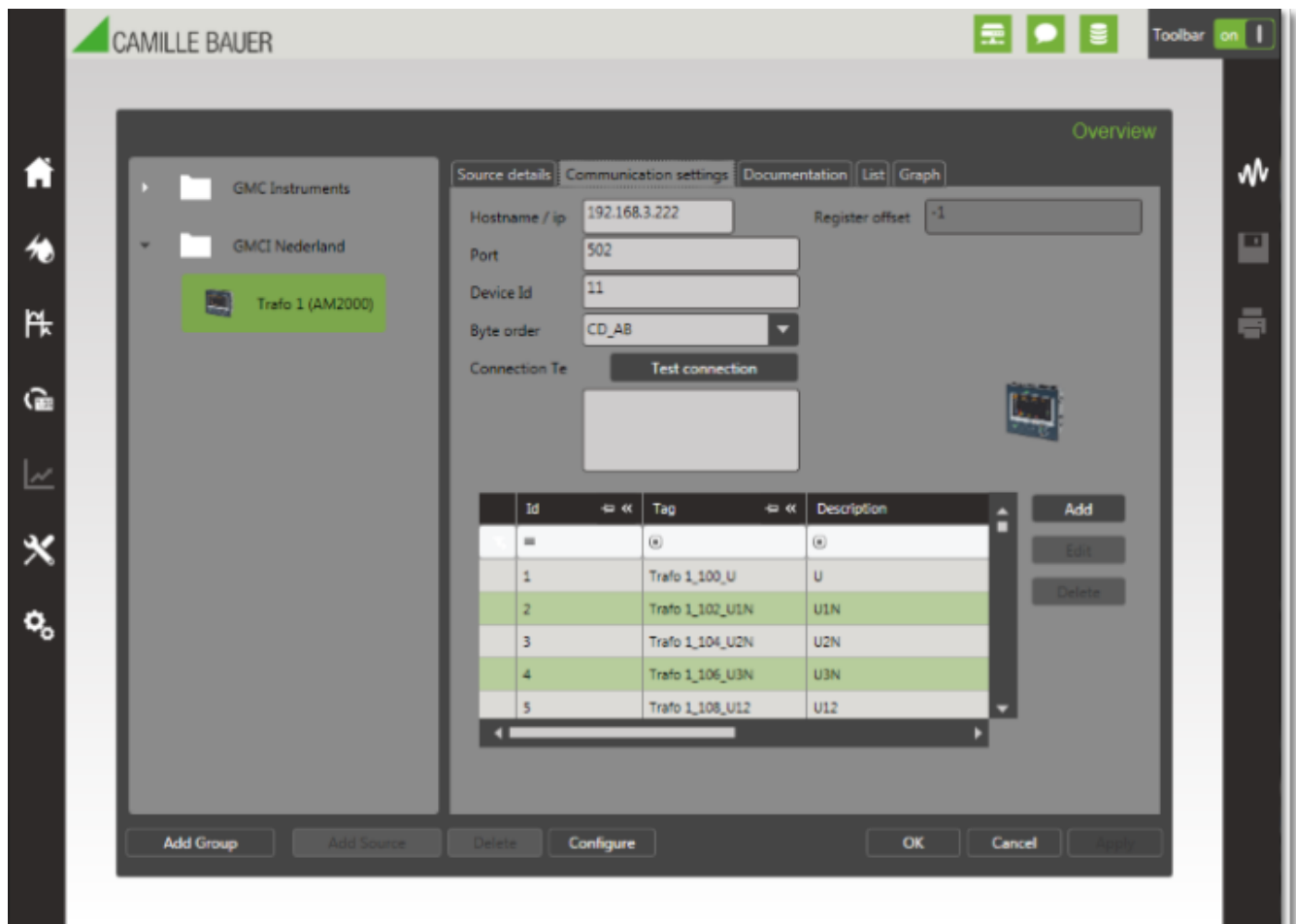

In this screen you can test the settings with the "Test connection" button. However when the service is already running and collecting data for this device, the test can fail although the settings are correct because a lot of devices have problems handling multiple connections at the same time. If it is a Modbus RTU device, like above, and the SmartCollect Service is already running it will always fail because in Windows only one process can connect to a serial port at a time. Since the service is running and collecting data, the service is connected to the serial port and therefore blocking the access for the client application. With devices that use a serial port it will also fail if the client is not running on the same system as the service since the serial port (which it should use to check the connection) is on the server where the service is running and not on the workstation where the client is running.

Documentation

The tab documentation will allow you to create links to documents, images, URL's or whatever files you intend to use, that is associated with this specific device. This way you can create a link to the operating manual, to a detail image of the device, a photo of the location of the device or to the product page on the website of the Camille Bauer Metrawatt AG. The links will be opened in the appropriate application when you double click the item in the list box.

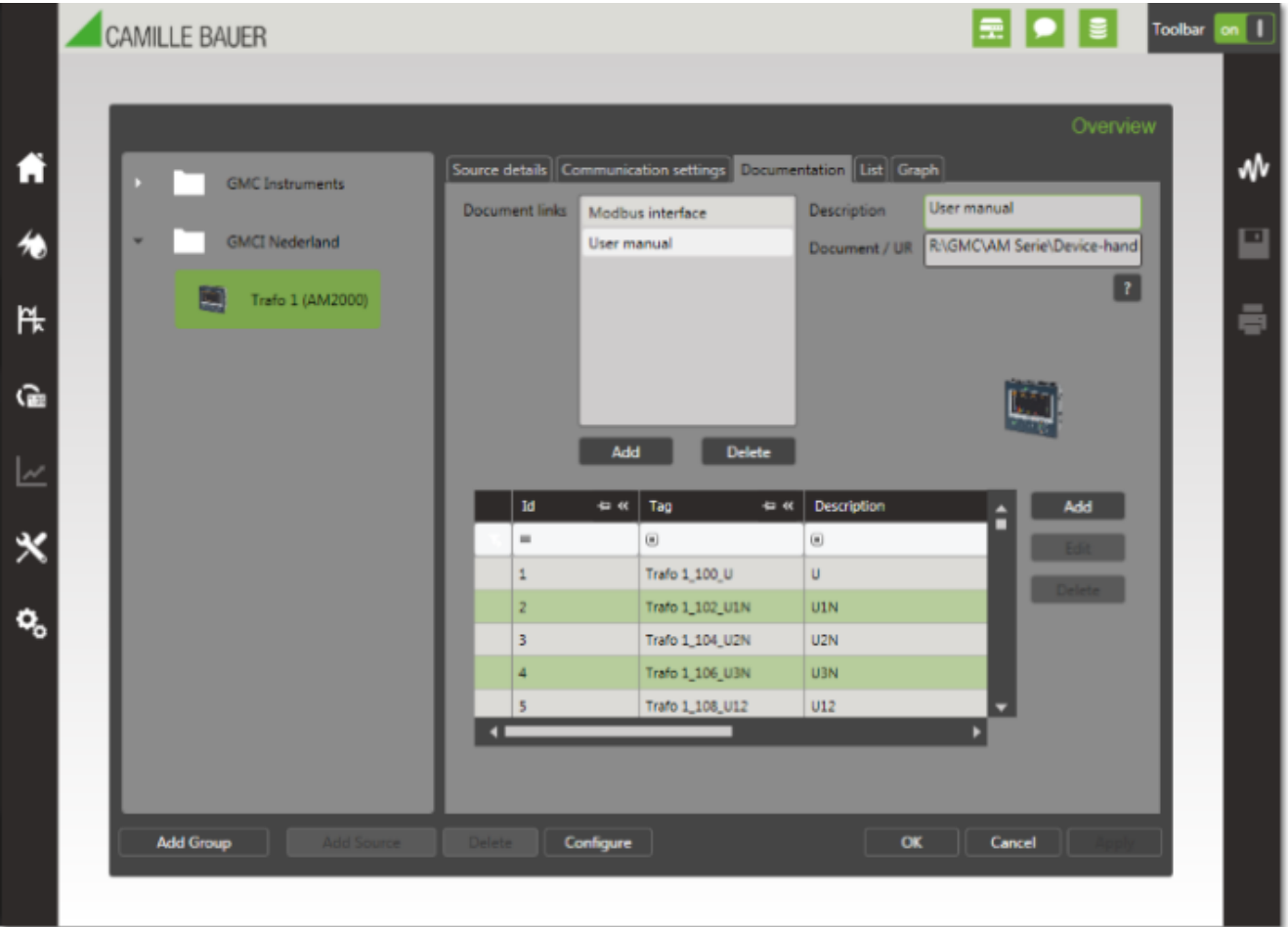

List

The list tab will allow you to view the values that are recorded for a specific channel. Just select the channel you want to see, the time period you want to see and then click "Load history" and the data will be loaded into the grid.

The screenshot shows the SmartCollect software interface. On the left is a sidebar with a tree view containing 'GMC Instruments' and 'GMC Nederland', with 'Trafo 1 (AM2000)' selected. The main window has tabs for 'Source details', 'Communication settings', 'Documentation', 'List', and 'Graph'. The 'List' tab is active, showing a table with the following data:

Timestamp	Channel	Unit	Value
2-10-2015 15:56:59	Trafo 1_102_U1N	V	225,2555
2-10-2015 15:56:50	Trafo 1_102_U1N	V	225,3169
2-10-2015 15:56:41	Trafo 1_102_U1N	V	225,311
2-10-2015 15:56:32	Trafo 1_102_U1N	V	225,4197
2-10-2015 15:56:23	Trafo 1_102_U1N	V	225,4458
2-10-2015 15:56:14	Trafo 1_102_U1N	V	225,4788
2-10-2015 15:56:06	Trafo 1_102_U1N	V	225,6104
2-10-2015 15:55:57	Trafo 1_102_U1N	V	225,5309
2-10-2015 15:55:48	Trafo 1_102_U1N	V	225,5964

At the bottom of the table area, there are buttons for 'Load history', 'Export to Excel', and 'Automatic refresh' (checked), with a dropdown menu set to '10 seconds'.

When you want to use the data in a Microsoft Excel spreadsheet for further analysis you can click to "Export to Excel" button and enter a filename and the data will be saved to a new Excel Sheet.

If you want to see the values coming in when recorded you can select a refresh interval with the dropdown list and then click the "Automatic refresh" checkbox. Within the specified interval the data in the grid will be refreshed from the database. This way you don't have to keep clicking the "Load history" button every time the see new values.

Graph

The graph tab shows the same data as the list tab but then represented in a graph.



Also in this screen you have the option to switch on automatic refreshing of the graph as already explained with the "List" tab.

5.1.3 Channels

To see the details of a specific channel you can click the on channel and then click the "Edit" button on the right or you can double click the channel in the grid. Either way, a new popup screen is shown with the details of the selected channel. To add a channel you can click "Add" on the right hand side and a new channel is created and the same popup screen is shown.

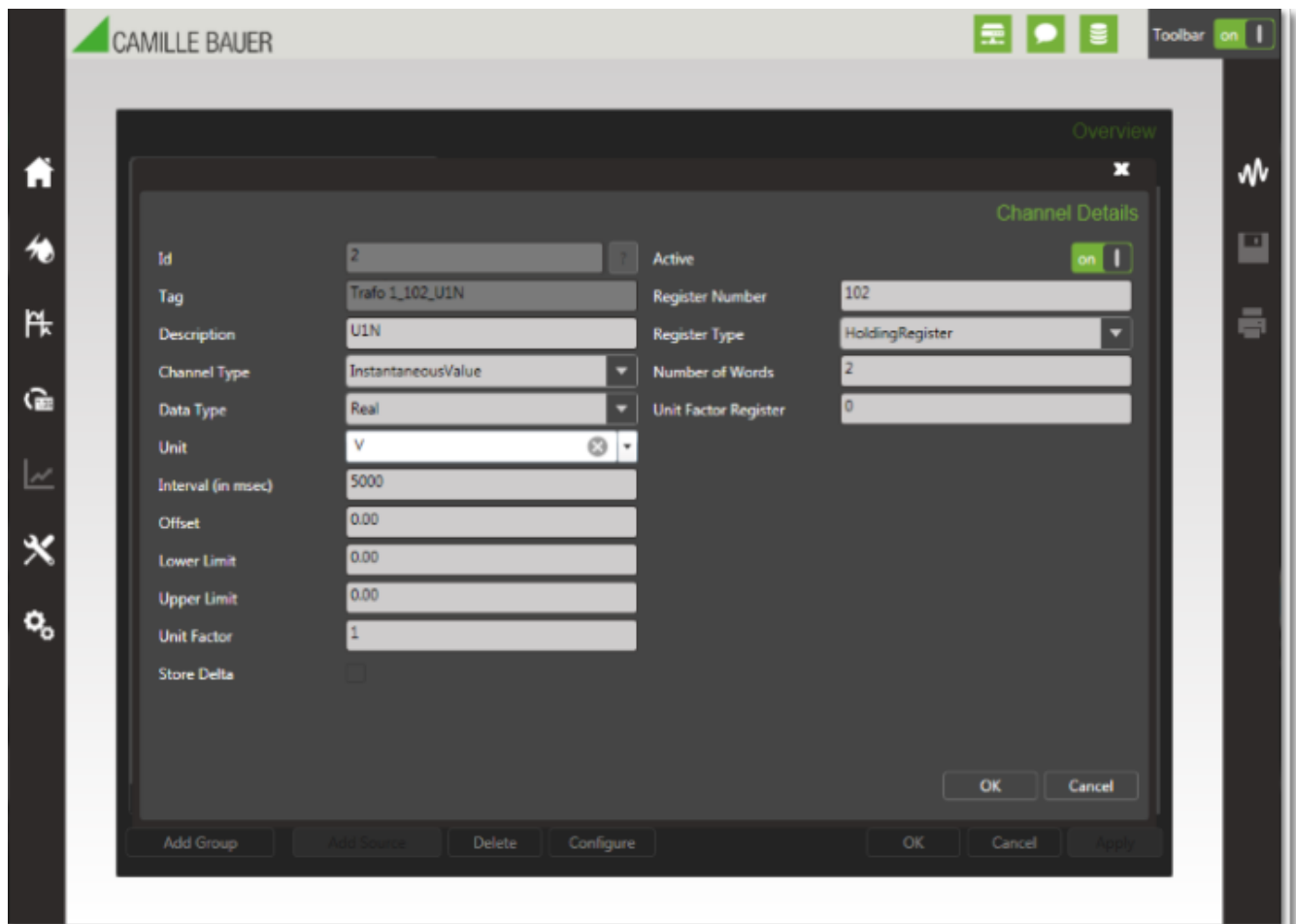

In the table below the fields of this screen are explained.

Field name	Description
Id	<p>For all devices, except Smartcontrols, this is just a numeric value to uniquely identify the channel.</p> <p>With Smartcontrols the Id value corresponds to the Id value of the programming block in the Smartcontrol Manager. You can easily look these values up from SmartCollect by clicking the "?" button on the right of the field. This will bring up a popup screen that will show all the available Id's of the Smartcontrol.</p>
Tag	This is an alphanumeric value, with a maximum of 50 characters, that uniquely identifies this channel. It needs to be unique not only for this specific device but it needs to be unique over all devices.
Description	A description of the channel. This description will be used on reports. The maximum length is 250 characters.
Channel Type	This value tells the application what kind of data is recorded for this channel. This is important because it will determine if you will be able to select this channel for certain reports.
Data Type	The data type will tell the system how to handle or process the data that is received from the device.
Unit	The unit of this channel. Always try to record the values in base units. For example, Wh instead of kWh.
Interval	The interval at which this channels needs to be recorded. Every channel can have its own interval. When setting the interval take into account the protocol used, the number of channels to read at this device and the overall speed of the device. Setting the interval to small could mean the device can not keep up and this will lead to error messages.
Offset	<p>A value that is added to the value received from the device. The value can be a negative value.</p> <p>Offset can be used, for example, in case an energy counter is</p>

Field name	Description
Lower Limit	replaced and you want the counter value in the SmartCollect database the continue where the old counter ended. In that case the end value of the old counter is entered in this field and will be added to the value received from the new counter.
Upper Limit	A warning is given in the state icons when the value of the channel drops below this value. When both Lower Limit and Upper Limit are 0.00 then checking the limits is disabled.
Unit Factor	A warning is given in the state icons when the value of the channel exceeds this value. When both Lower Limit and Upper Limit are 0.00 then checking the limits is disabled.
Store Delta	The value received from the device is multiplied with this value.
Active	For specific units (Wh for example) it is possible to also store the difference between the last value and the newly received value.
<u>Modbus specific settings</u>	
Register Number	Determines if the channel is currently being collected or not.
Register Type	The coil or holding register number.
Number of Words	If it is a coil or a holding register.
Unit Factor register	The number of words of bytes the register consist of.
<u>ECL specific settings</u>	
Channel name	Some devices have a specific 16 bit register that contains the unit factor of this register. When this is entered here the field "Unit Factor" is ignored.
ECL Function	The name of the channel to read.
<u>OPC specific settings</u>	
OPC Itempath	The ECL function to use when reading channel name.
	The path to the OPC item.

5.1.4 Add Device Wizard

With the "Add Device Wizard" you can easily and quickly add devices to the application. Below you see the startup screen of the wizard where you select the device you want to add from the dropdown list.

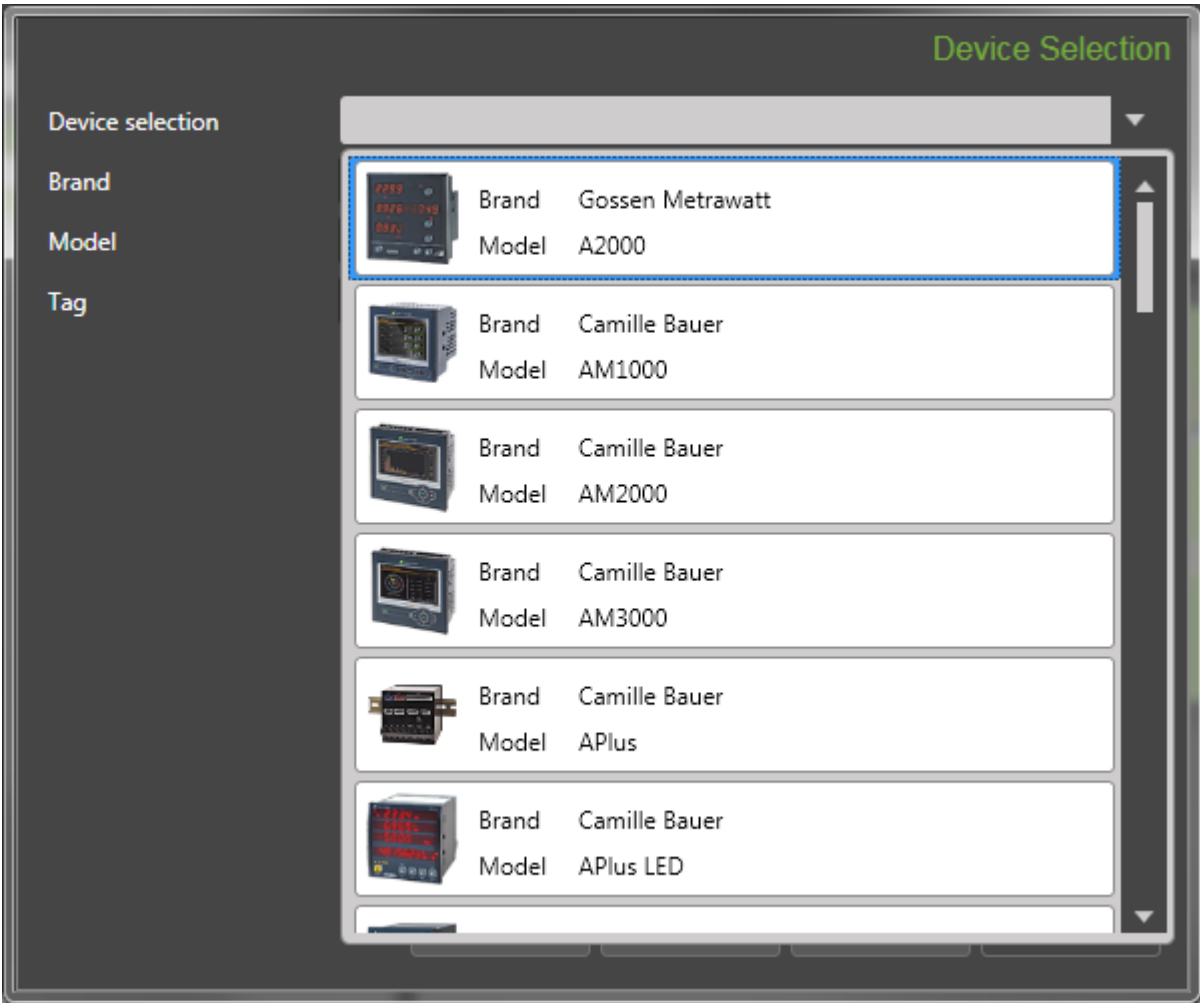

After selecting the device you only have to add a tag (a unique identification string) for the device.

Device Selection

Device selection

Brand

Model

Tag



The image shows a Camille Bauer APlus device screen. The screen displays a 'Vector diagram' on the left, which is a circular plot with three axes (L1, L2, L3) and a central point. To the right of the diagram is a table of electrical parameters:

L1	L2	L3
238	235	239V
130	129	91A
0	120	240°
10	6	7°
0.93	0.99	0.99PF
30	30	21kW
5	3	0kvar
31	30	22kVA

Below the screen are five numbered buttons (1-5) and a navigation bar with 'Previous', 'Next', 'Finish', and 'Cancel' buttons.

You can click "Next" to go to the next screen. The type of this next screen depends on the selected device. If the device only supports one communication protocol then you are taken straight to the screen where you can enter the settings for this specific protocol. However, if the device supports multiple protocols, as is the case with an *APlus*, you go first to the screen where you can select the protocol you want to use.

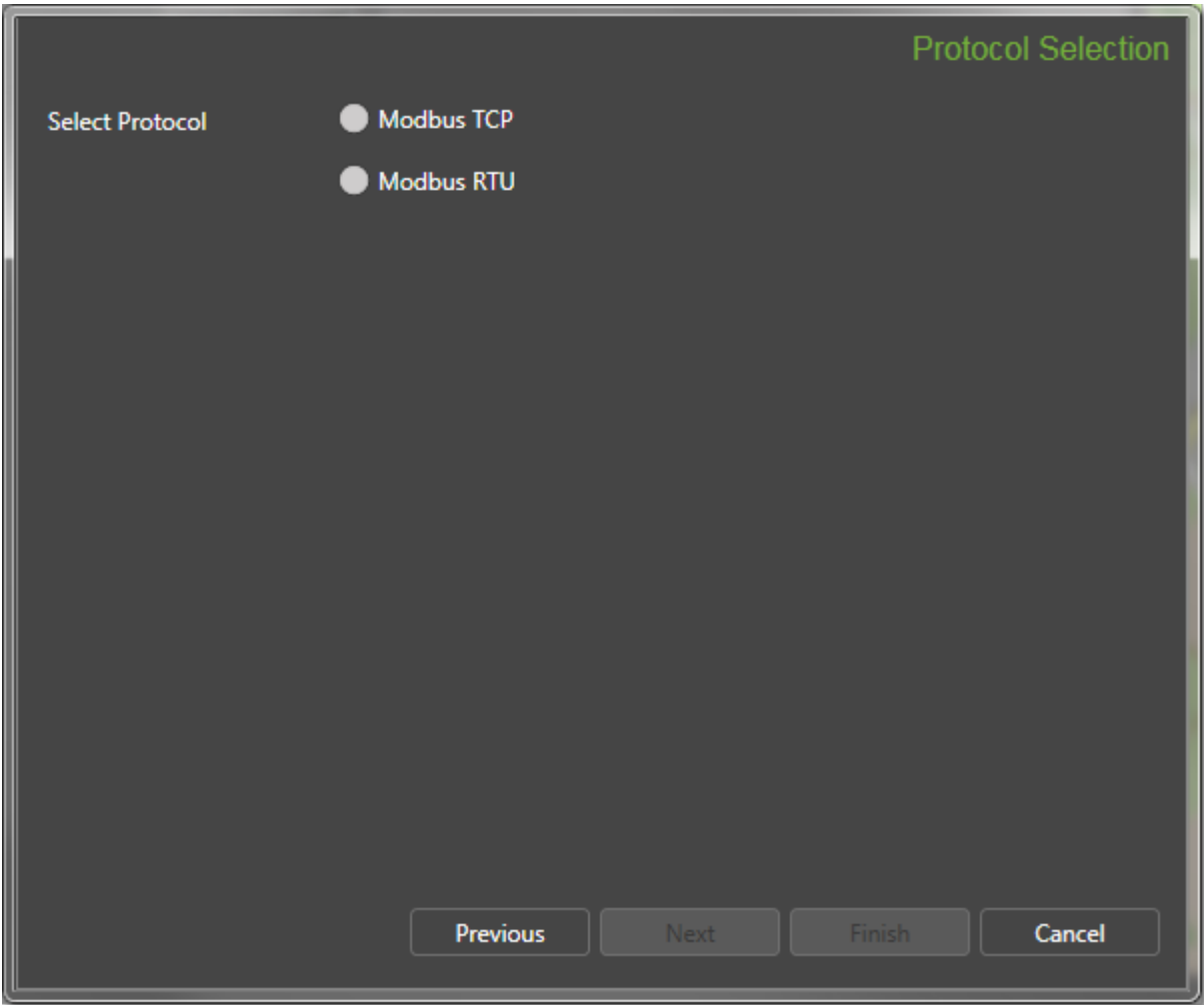

After selecting the correct protocol you can click "Next" to go to the screen where you can enter the settings of the selected protocol.

Modbus TCP Settings

Hostname / ipaddress 192.168.2.110

Port Number 502

Device Id 255

Test connection

Connection Test Result Connection and model check succeeded.

Previous Next Finish Cancel

After entering the settings you can click the "Test connection" button to verify that the connection to the device can be made successfully. If the connection cannot be verified at this moment, you can click "Next" straightaway to go to the next screen.

 If it is a Modbus RTU device and the SmartCollect Service is already running and using the configured serial port, it will always fail because in Windows only one process can connect to a serial port at a time. Since the service is running and collecting data, the service is connected to the serial port and therefore blocking the access for the client application. With devices that use a serial port it also will fail if the client is not running on the same system as the service since the serial port it should use to check the connection is on the server where the service is running and not on the workstation where the client is running.

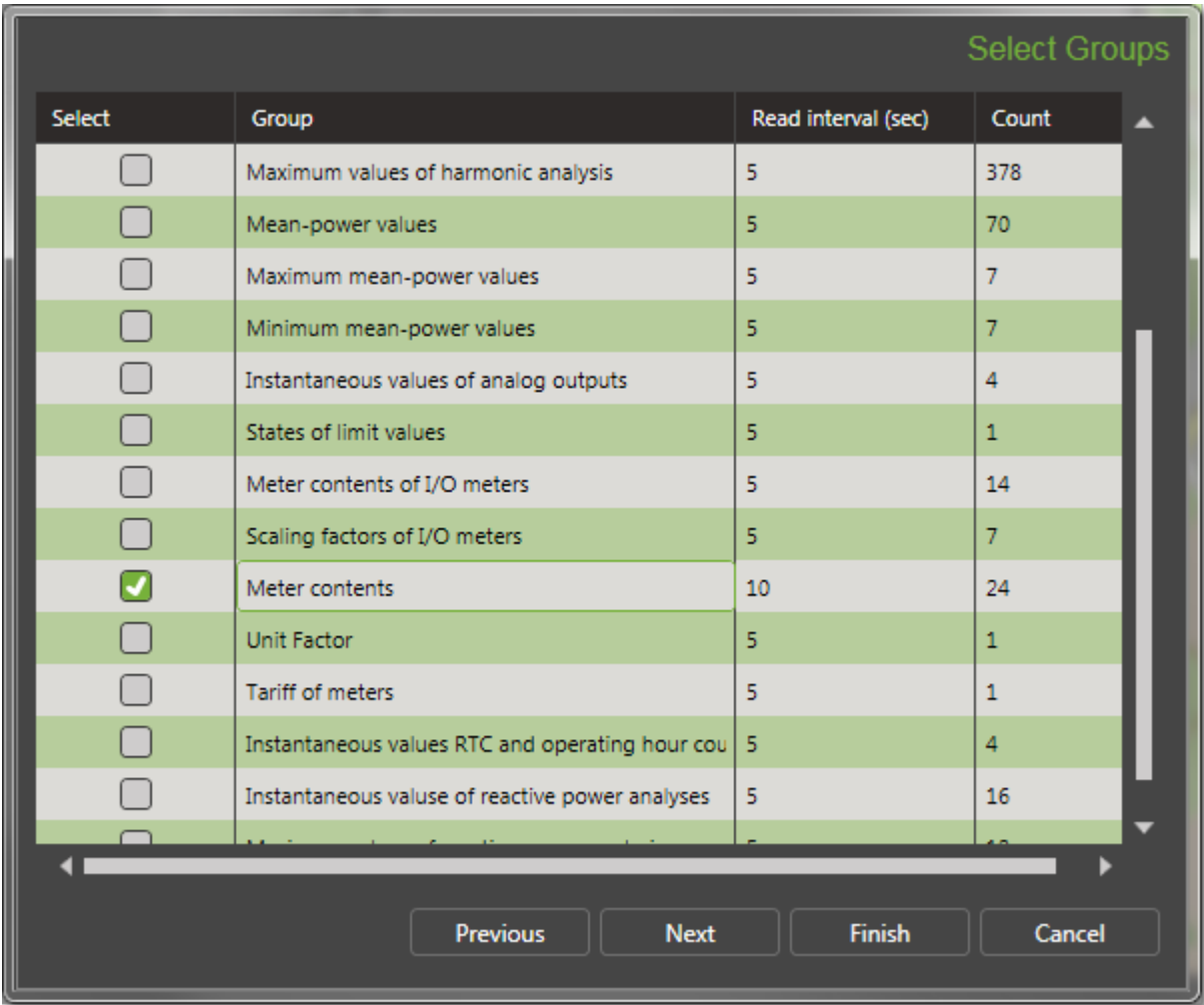

In this screen you can select one or more sets of values you want to collect. The count column shows how many different measurements there are in a group. If you want to select only a few values you can click "Next" without selecting a group to take you to the screen where you can select the measurements individually.

With the column "Read interval (sec)" you can set an interval for all measurements in the group at once. When setting an interval you should always keep in mind the number of channels you want to collect in total and the protocol that is being used to collect them. These two facts are the most important variables for determining the fastest interval that is possible. For example, collecting 600 values from a device with Modbus RTU and an interval of 5 second will not be possible. The reason for this is that collecting one value with Modbus RTU takes about 30 to 40 ms (this will also depend on the hardware specifications of the device) and $40 \text{ ms} * 600 \text{ values} = 24.000 \text{ ms} = 24 \text{ seconds}$.

After selecting one or more groups you can click "Finish" to leave the wizard and the device will be added to the application as configured, or you can click "Next" where you can see all possible measurements individually.

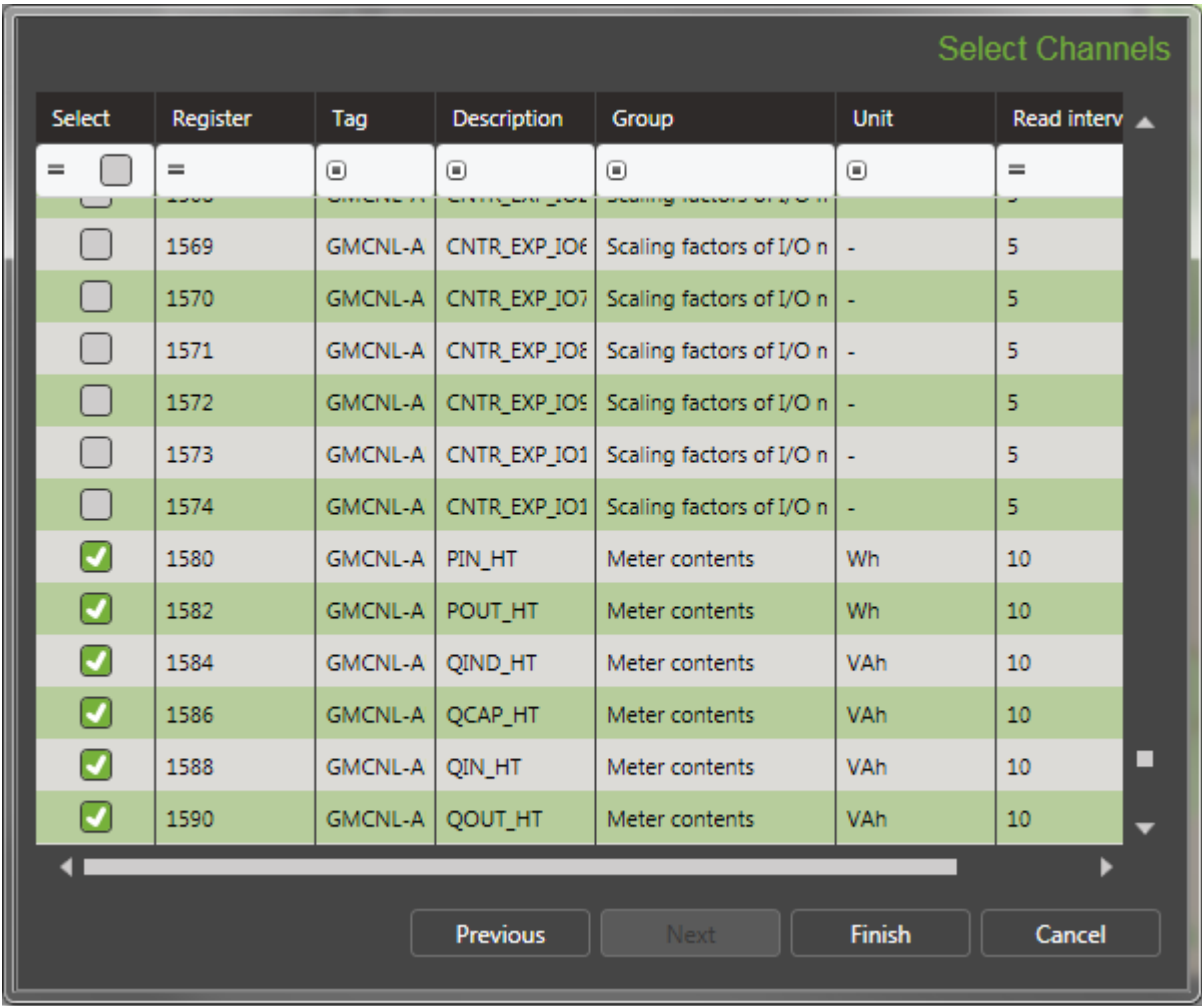

All measurements that are part of a group you selected in the previous screen will be selected in this screen and if you changed the interval in the previous screen you will see that every individual measurement has the same interval you defined for the group. In this screen you can select additional measurements or deselect some of the already selected ones if you do not need them. You can change to default or already set interval for each measurement.

After having selected the measurements and set the interval appropriately, you can click "Finish" to end the wizard and add the device to the application.

At any time you can click "Previous" all the way to the beginning without losing any changes you made unless you select a different device at the start screen.

5.2 Energy Management

The SmartCollect Energy Management module can be used to create automated energy management reports. There are two types of centers available that you can use to determine which devices and channels are printed in a report. You can use a cost center to print energy consumption and load profiles and you can use the overview center to print line graphs of selected channels.

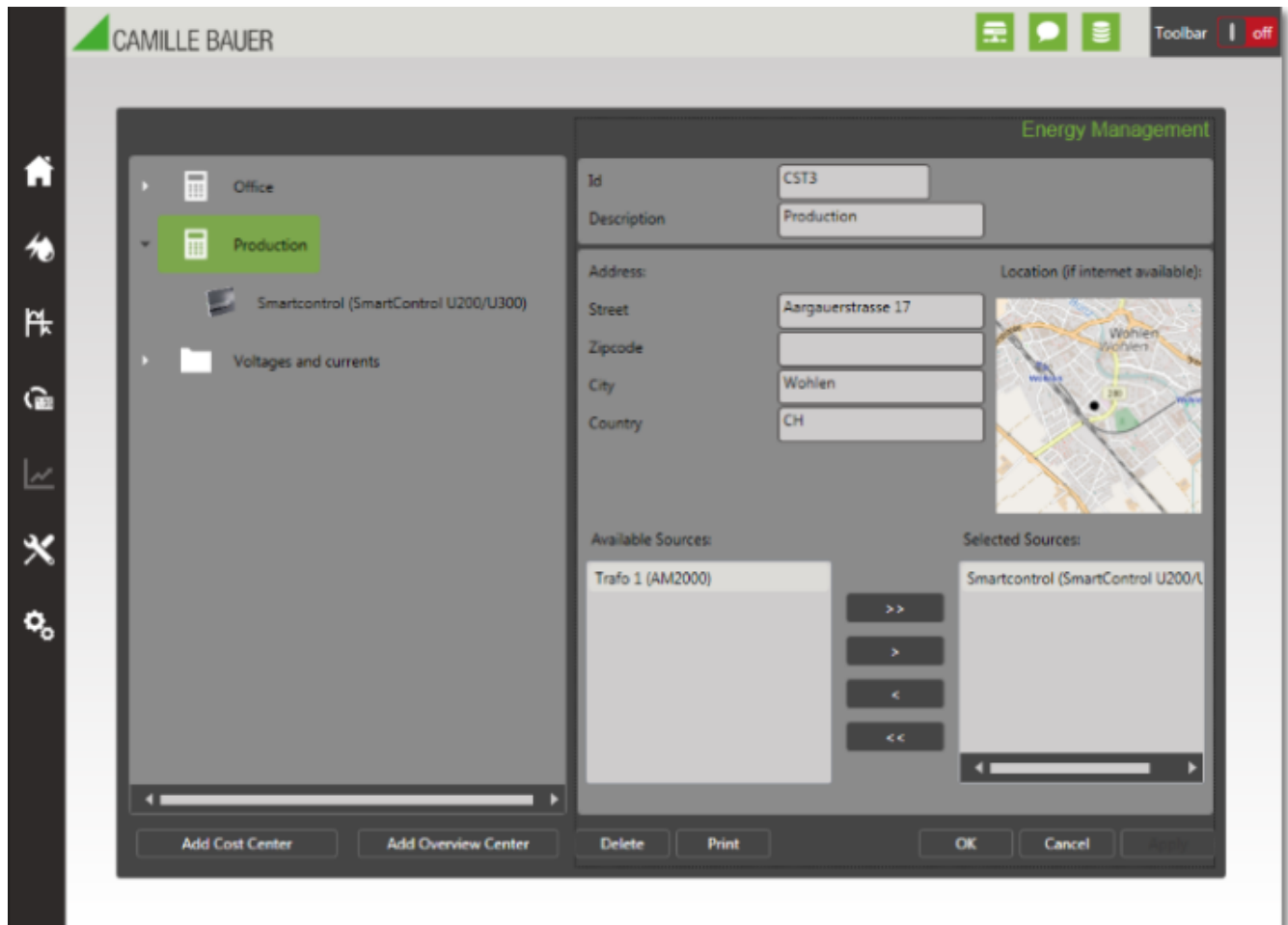

To add a cost center you can click on "Add Cost Center" and enter a short code as an Id and a description for this cost center and then select the devices that belong to this cost center. You can assign the same device to as many cost centers as you want. After having selected the devices you click on "Apply" and the cost center and the selected devices are added to the menu and the tree view.

The next step is to select the channels for each device that belong to this cost center. You simply click on the device in the tree view and the following screen is shown.

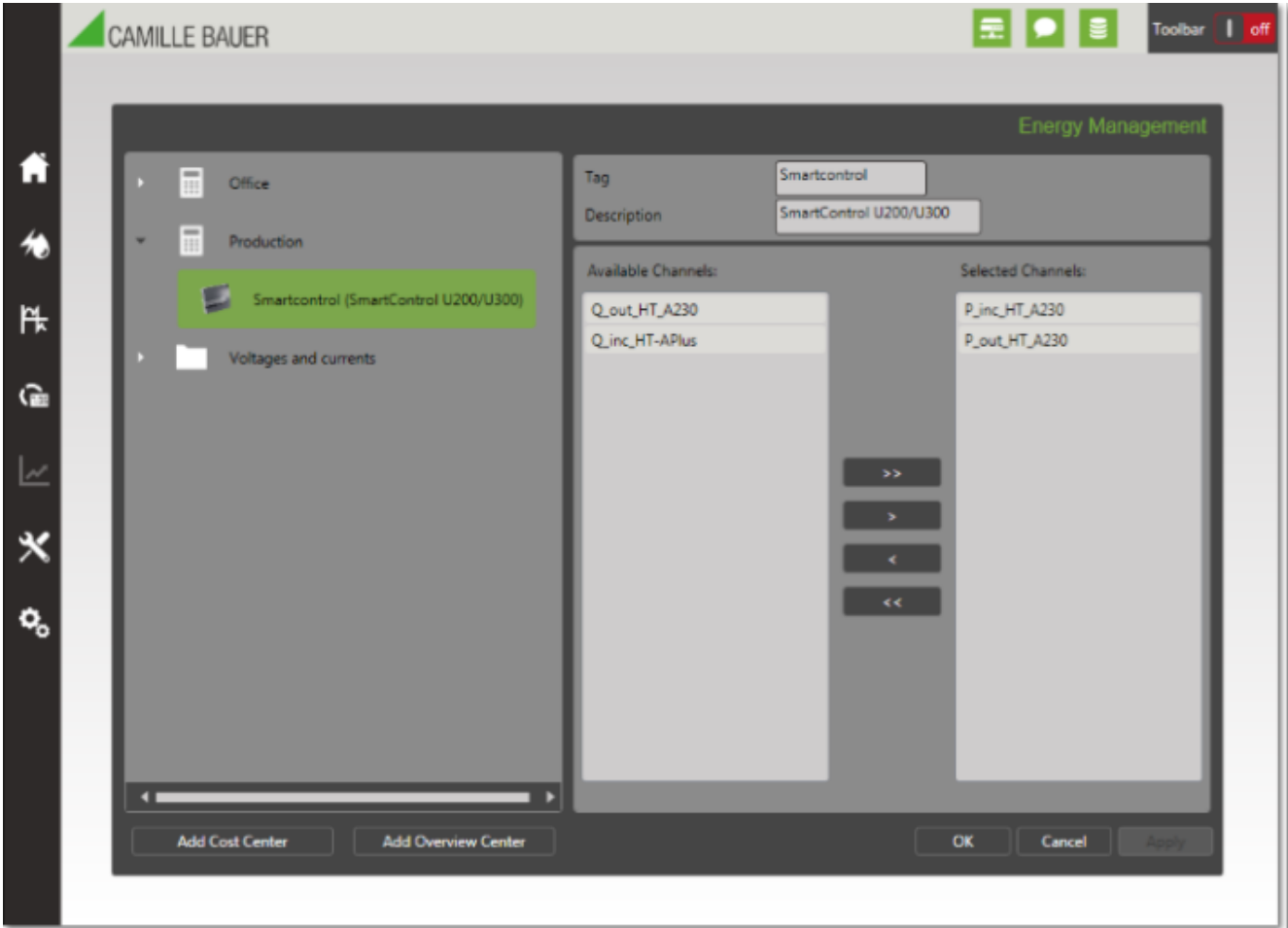

In this screen you can select the channels you want to add, multiple selections is supported, and move them to the selected channels list.

Now the configuration of a cost center is completed. The next step is to **print (Section 5.2.1)** or **schedule (Section 5.2.2)** a report based on this cost center.

5.2.1 Print Consumption Reports

To print the energy consumption data, for example power consumption, you go to the cost center screen of your choice and then click "Print". This will show the screen below.

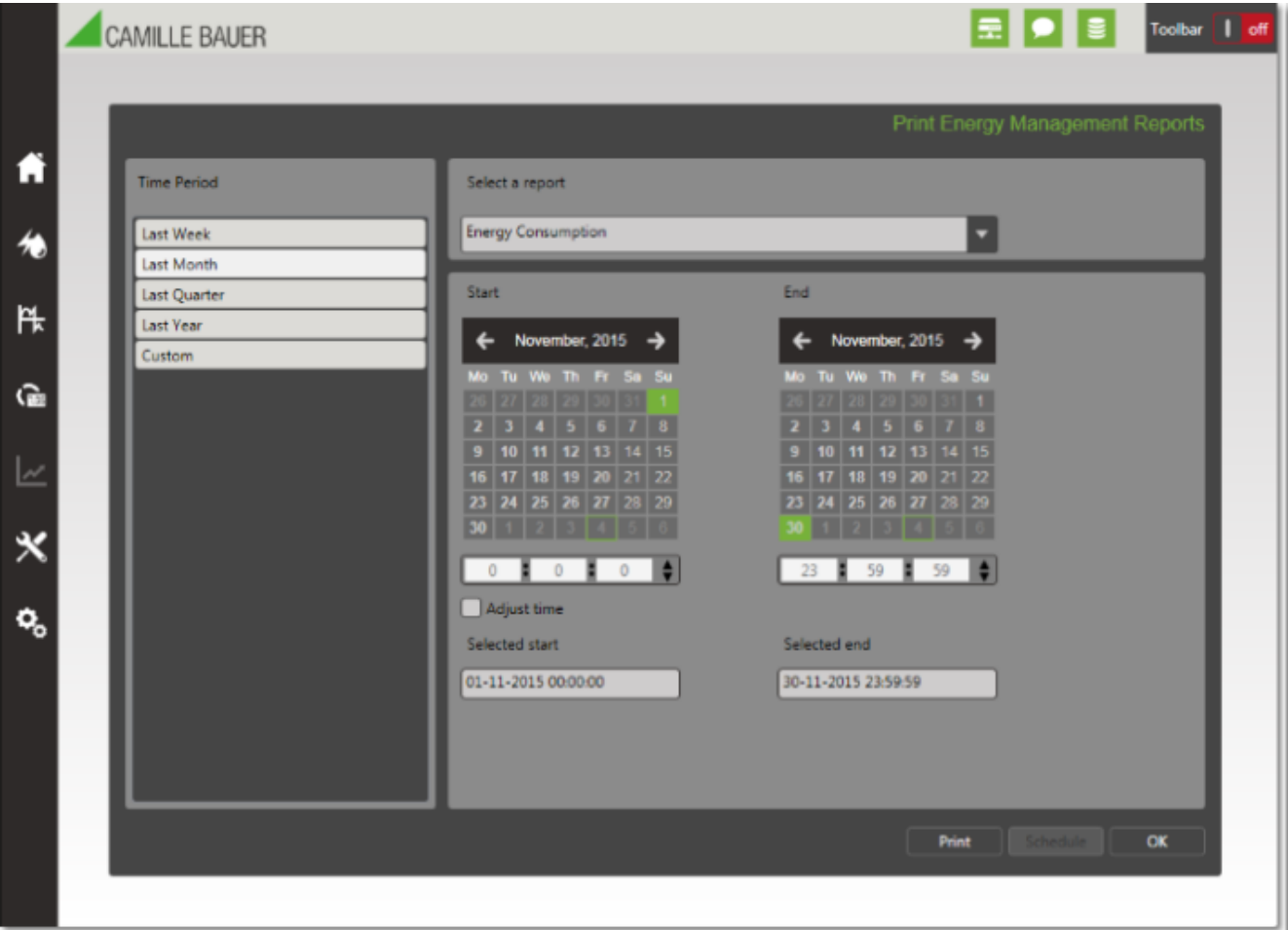

In this screen you can select the time period for the report, either a predefined period like "Last Week" or "Last Month" or a custom period you can select yourself with the calendar controls. You can then click "Print" to display the report.

Energy Usage Report

Cost Centre 1
Aargauerstrasse 7
CH-5610 Wohlen
Switzerland

Selected timeline: 1-8-2014 to 17-9-2014 Generated on: 17-9-2014 14:18:16

Energy Counters Incoming

Device name	Tag	Counter description	Tar.	Energy kWh	Peak val	Date peak	Time peak
Sineax A210	GMCD E-A210	P incoming LT	LT				
Sineax A210	GMCD E-A210	P incoming HT	HT	0,54	0,30	9-9-2014	13:53:13
Total group				0,54			

Energy Counters Outgoing

Device name	Tag	Counter description	Tar.	Energy kWh	Peak val	Date peak	Time peak
Sineax A210	GMCD E-A210	P outgoing LT	LT				
Sineax A210	GMCD E-A210	P outgoing HT	HT				
Total group				0,00			

Reactive Energy Counters Incoming

Device name	Tag	Counter description	Tar.	Energy kVARh	Peak val	Date peak	Time peak
Sineax A210	GMCD E-A210	Q inductive / incoming LT	LT				
Sineax A210	GMCD E-A210	Q inductive / incoming HT	HT				
Total group				0,00			

Reactive Energy Counters Outgoing

Device name	Tag	Counter description	Tar.	Energy kVARh	Peak val	Date peak	Time peak
Sineax A210	GMCD E-A210	Q capacitive / outgoing LT	LT				
Sineax A210	GMCD E-A210	Q capacitive / outgoing HT	HT	0,10	0,06	9-9-2014	13:53:14
Total group				0,10			

Page 1 of 1

In this screen you can print or email the report or save it as:

- Adobe Acrobat file (PDF)
- Rich text file
- HTML file
- MHT file
- XML excel table
- Excel 2007 file
- Word 2007 file
- PowerPoint 2007 file
- OpenOffice Calc file
- OpenOffice Writer file
- Microsoft XPS file
- CSV file
- DBF table
- Text file
- Image file (BMP, PNG, JPG, GIF, TIFF, EMF)
- XAML file
- SVG file

As an alternative of printing the report yourself you can configure a schedule to receive the report as an attachment in PDF in your mailbox. See **this page (Section 5.2.2)** for information about scheduling.

5.2.2 Schedule Energy Consumption

Besides printing you can schedule reports so that you will receive them in PDF format in your mailbox when a report is

scheduled to be printed. For this you click "Schedule" in a print screen and then the screen below is shown.

This screen allows you to make any schedule you like. In the screenshot the report is scheduled to run every Friday afternoon at 5:00 pm, starting at September 18th 2014 and ending at January 1st 2100. So every Friday afternoon the email-address info@camillebauer.com will receive an email with the print out of the report as a PDF attachment.

The checkbox "Save difference between selected date and system date" can be used to adjust the dates automatically as selected in the print screen. For example, you always want to print the last 7 days and today, 1/21/2015, you selected to print the data of 1/13/2015 until 1/20/2015. If you would schedule this without checking the mentioned checkbox, you would always get a report with the data of 1/13/2015 until 1/20/2015 which is probably not what you intended. However if you do check the checkbox it will always print the last 7 days no matter when the report is printed. So when the scheduler prints your report on, let say, 6/15/2015 you will get the data of 6/7/2015 until 6/14/2015.

⚠ If the button "Schedule" is grayed out it means that the SmartCollect Client could not contact the Scheduler service on the configured hostname. To adjust this you can use the **SmartCollect Configurator (Section 6)** to enter the correct hostname. If the correct hostname is entered and the Client can still not connect to the service than perhaps your firewall or the firewall on the server running the SmartCollect Scheduler is blocking the communication port of the Scheduler which is 555.

5.3 Power Quality

The Power Quality module, in short, can be used to analyze the data retrieved from the supported power quality devices. This data is automatically retrieved from the devices by downloading PQDIF files from the device, reading out these files and store the information in database tables.

The first step in setting up the Power Quality module is **adding one of the supported power quality devices**

(Section 5.3.1) in Overview. In this step you configure how the PQDIF data is downloaded from the device and if you want to save a copy of the file on disk or in the database. Then after restarting the SmartCollect Data Collection service, this service will connect with the device, at the configured interval, to download any PQDIF file present on the device. You can see the imported files in the "Import/Export" screen.

Once data is imported you can use either the "Cyclic Data" screen to look at the data from the permanent recorder of the device or you can use the "Events" screen to see all events triggered on the device. If the device is configured to store 10 ms and/or scope recordings, you can see them as well in the "Events" screen.

You can use the "Reports" screen to print EN50160 reports. The "Online" screen is can only be used in combination with the PQ3000 power quality device of Camille Bauer Metrawatt and can be used to get real time power quality data of the device without the need of first importing it into the SmartCollect database.

One thing to keep in mind is that SmartCollect cannot show data that is not recorded. This may sound logical and even silly to put in a manual. However, power quality devices need to be configured so the device will now that it needs to generate PQDIF files and what to store into these files. By default, most devices will not store much in the PQDIF files or maybe will not save PQDIF files at all.

5.3.1 Adding a power quality device

When using the wizard to add a power quality device to Overview, you will get 2 additional steps. To see the normal steps of this wizard, please look **here (Section 5.1.4)**. In this topic we only handle the 2 extra steps. Below is a screenshot of the first extra step.

In this step you configure how and often the PQDIF files are retrieved from the device. SmartCollect supports 3 different ways, via web services (as is used with the PQ3000), via FTP (as is used with the PQube3) and via HTTP but this last one is not used at the moment by any of the supported devices.

When a transfer method is selected you have to configure some additional settings dependent on the selected transfer method.

In the table below the fields of this step are explained.

Field name	Description
PQDIF transfer method	This determines if and how the PQDIF files are collected from the device.
Hostname / ip-address	Hostname of the device, ftp or web server the files should be downloaded from.
Username	If authentication is necessary, this field can be used to provide a username.
Password	If authentication is necessary, this field can be used to provide a password.
URL / Path	When HTTP is selected you can use this field to specify any additional URL. If FTP is selected you can use this field to specify a base path. SmartCollect will start searching for PQDIF files in this directory and all of its subdirectories.
Collection interval	Determines how often SmartCollect should check for new files.

 When FTP is selected SmartCollect searches for files with the extension pqd starting at the specified path and all subdirectories. Every found file will be downloaded and then deleted from the device. This means if you want to save a copy of these files, be sure you store these to disk or into the database by selecting the appropriate options in the next step of the wizard.

Below is a screenshot of the second extra step:

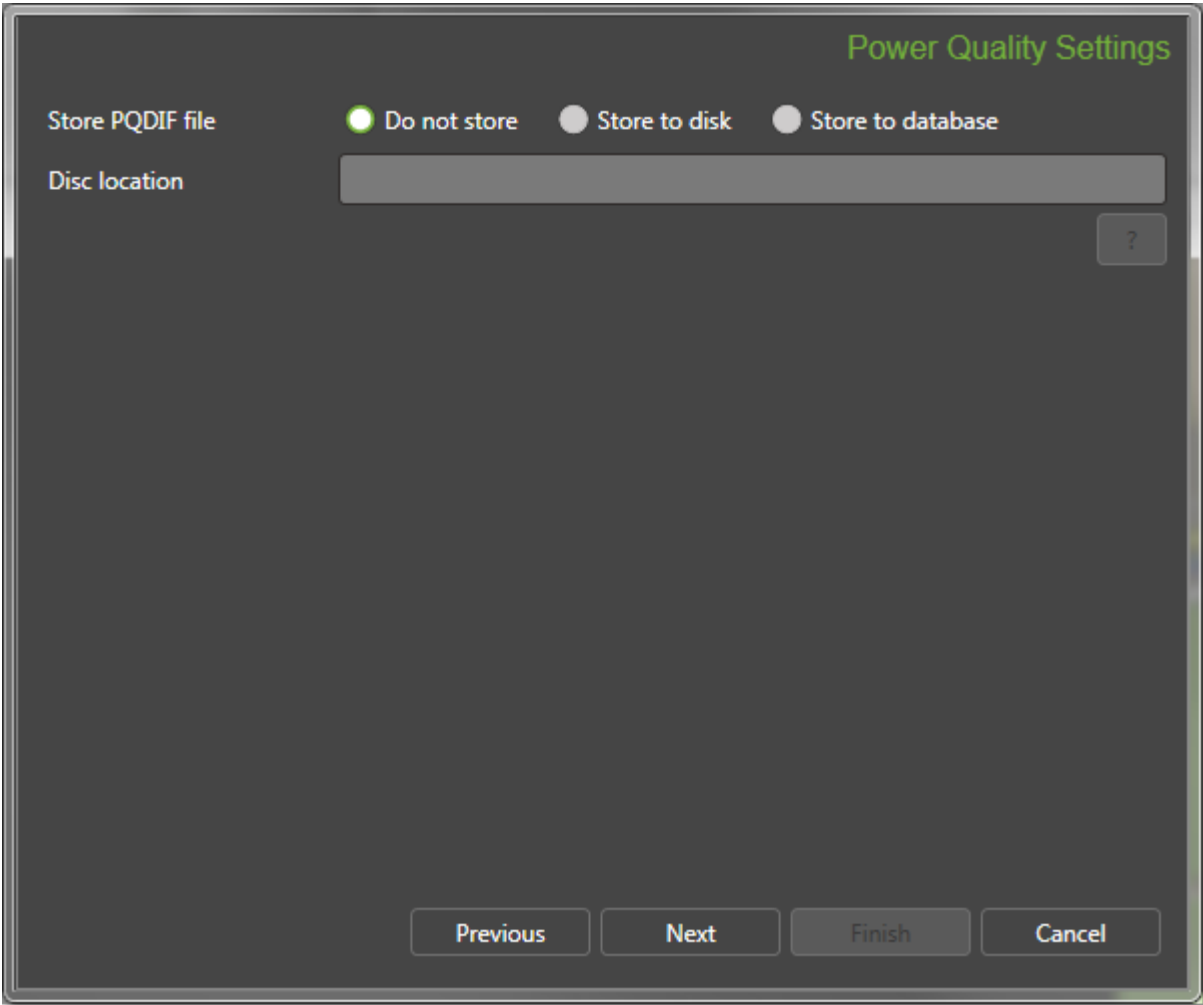

In this step you can configure if and how the downloaded PQDIF files are archived. All data contained in the file is of course imported into the database and its tables but this step offers you the possibility to archive the file itself. You

can archive the file to disk and then you have to provide a directory (preferably a network folder).

As an alternative you can store the file also in the database. The file itself is then stored in a table that contains a special field for this. With the "Import/Export" screen it can than always be downloaded again from the database if you want to use the file for analysis in for instance Dranview.

5.3.2 Cyclic Data

With the "Cyclic Data" screen you can analyze data that was recorded with the permanent recorder of the power quality device.



In the tree you can select which measurements you want to see and below the tree you can use the date and time selection tools to choose the time frame you want to see. When you click "Generate Graph", the appropriate graph is drawn and, if available in the data, the harmonics and inter harmonics are loaded.

If can also select measurements from a different device to compare them to each other. If you do, the screen is split and a second graph will be shown below the first graph, containing the measurements of the second device. You can select three different devices this way.

Legend

The legend will show you all measurements for whom data was found in the selected time frame. If a measurement you selected is not showing up in the legend, you know that there is no data for it. In the legend you can temporarily switch off one or more measurements, for instance to make a measurement you want a closer look at more visible. You can also change the line color of a measurement if you don't like the default color. Below a screenshot of a legend.

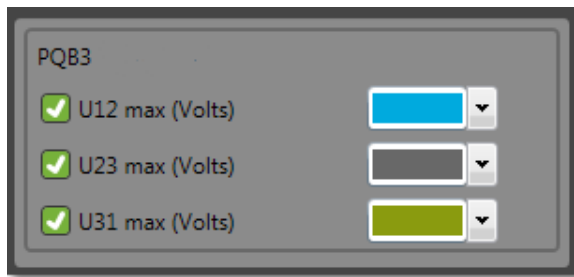

Zooming and panning

If you want to look in more detail to your graph you can zoom in three different ways. The first method is by using the so called zoombars at the bottom and on the right site of the screen. Below you see a screenshot of the horizontal zoombar.

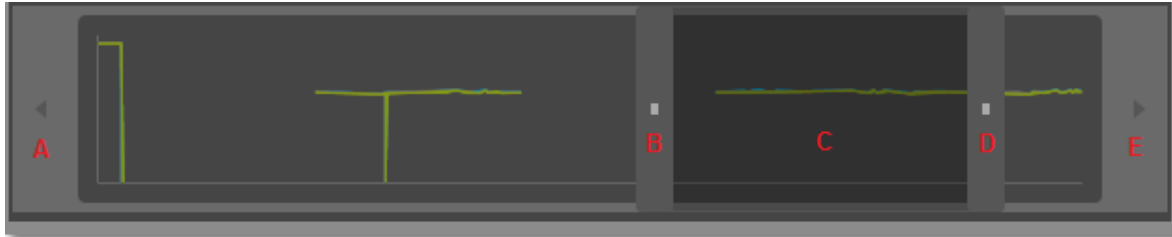

The horizontal zoombar shows a thumbnail of your graph in the background to make positioning easier. You can change the zoom level by grabbing B or D and slide them left or right. The main graph is immediately updated. By grabbing C you can pan to the left or the right to quickly look at another part of the graph or you can click on A or E to move the view to the left or right. If you want to zoom out you can drag B to A and D to E or you select "Auto scale" in the toolbar or you right click on the graph and select zoom out.

The vertical zoombar works exactly the same off course but does not show a thumbnail of your graph.

The second method of zooming and panning is by using the mouse. You can drag a square over the graph and instantly the graph will zoom in to that area and the zoombars are synchronized. To pan to a different part of the graph you can hold down the Alt key and then grab the graph and move it to where you want to go. The zoom out options are the same as mentioned before.

The third way is by holding your mouse cursor on the position you want to zoom in and use your scroll wheel to zoom in or out.

5.3.3 Cyclic Data Toolbar

On the right site of the screen a toolbar is shown that can be used for the following actions:

- Set limits
- Change the graph type
- Add comments
- Change back to auto-scale after zooming in
- Save a screenshot of the graph
- Print a screenshot of the graph

Set limits

The set limits option can be used to place 1 or 2 limit markers in the graph. When you choose "Set Limit 1", a popup windows is shown that allows you to enter where the limit marker should be drawn, in relation to which Y axis and the color of the line.

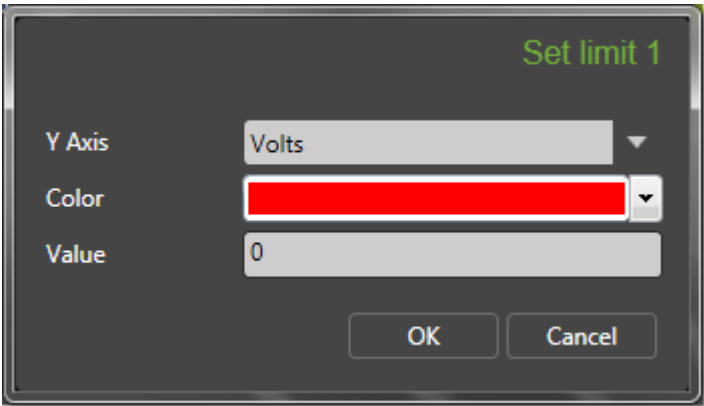

Change graph type

You can choose from 5 graph types:

- Column graph

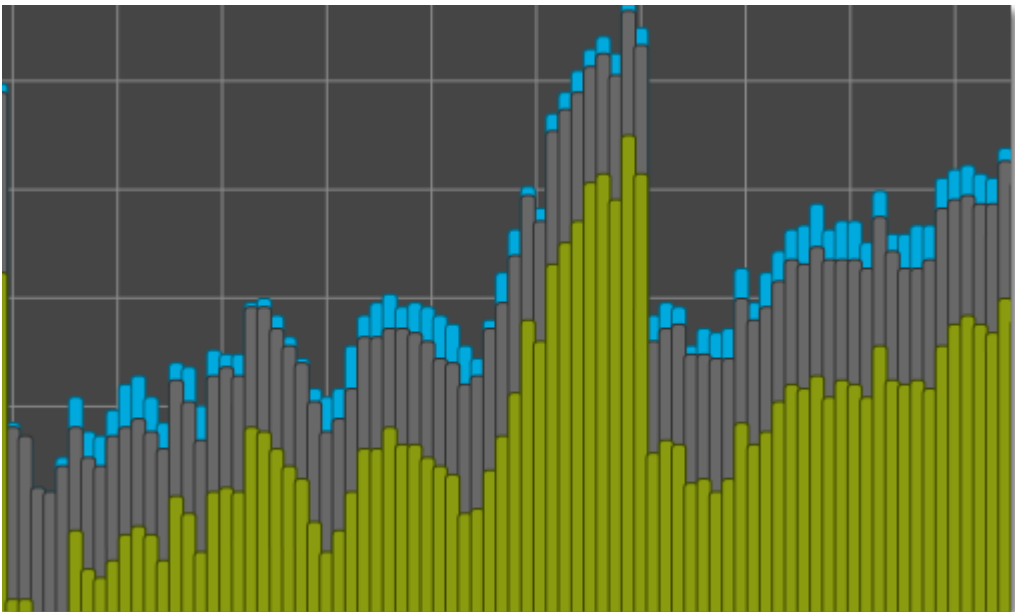

- Line graph (default)

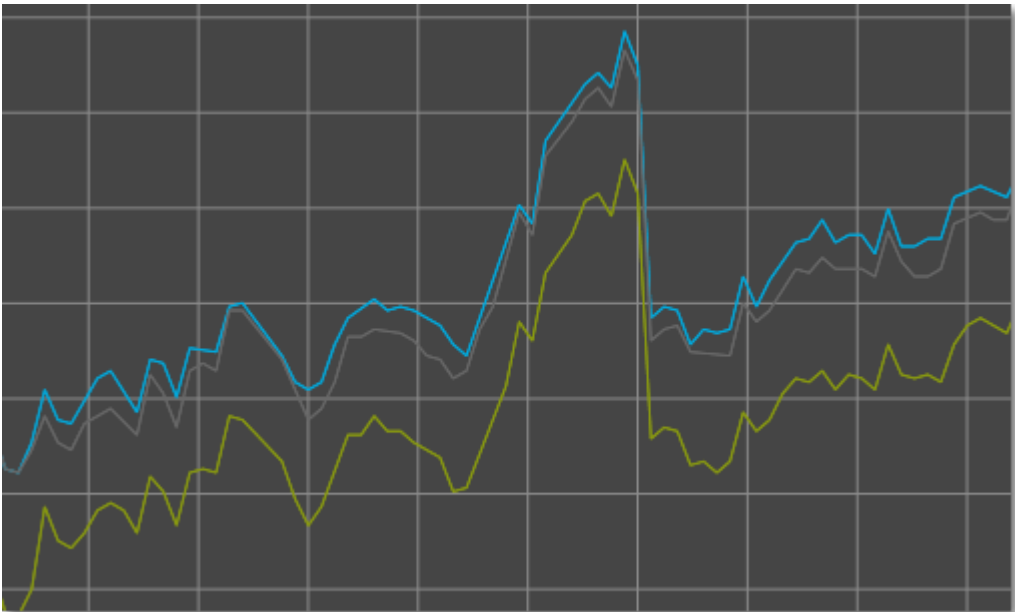

- Scatter graph

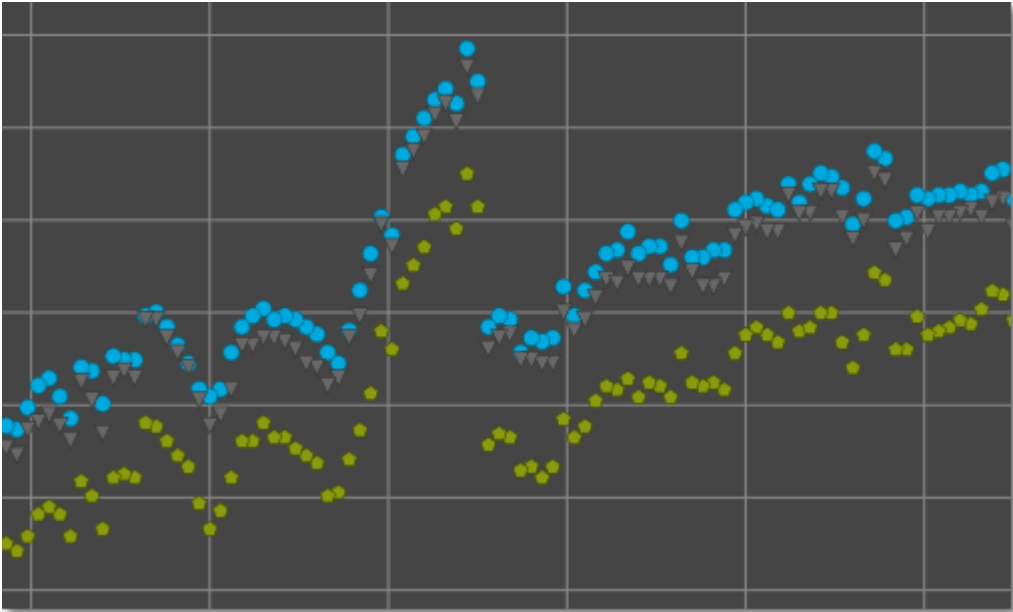

- Spline graph

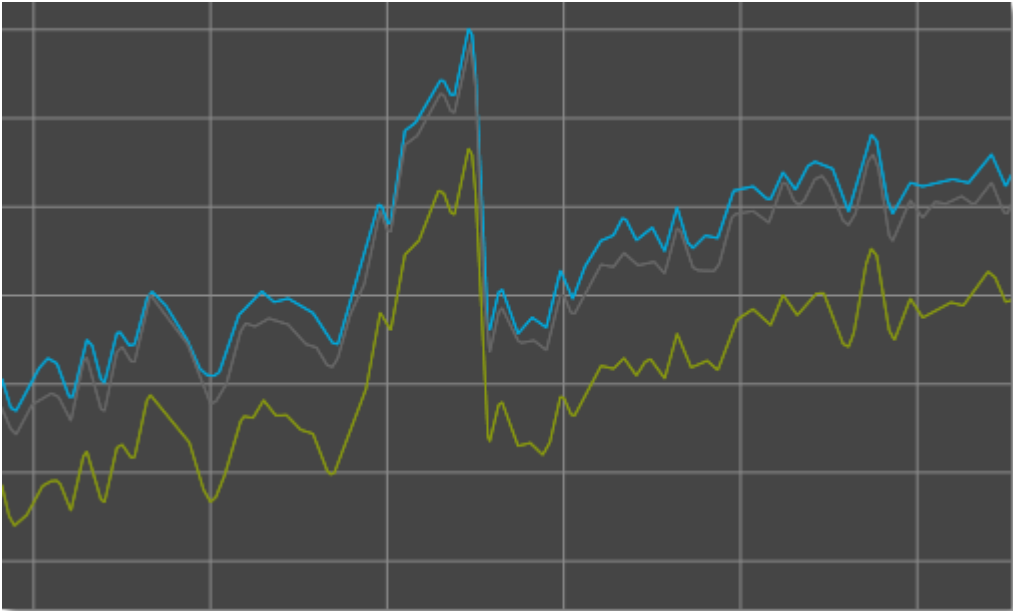

- Stepline graph

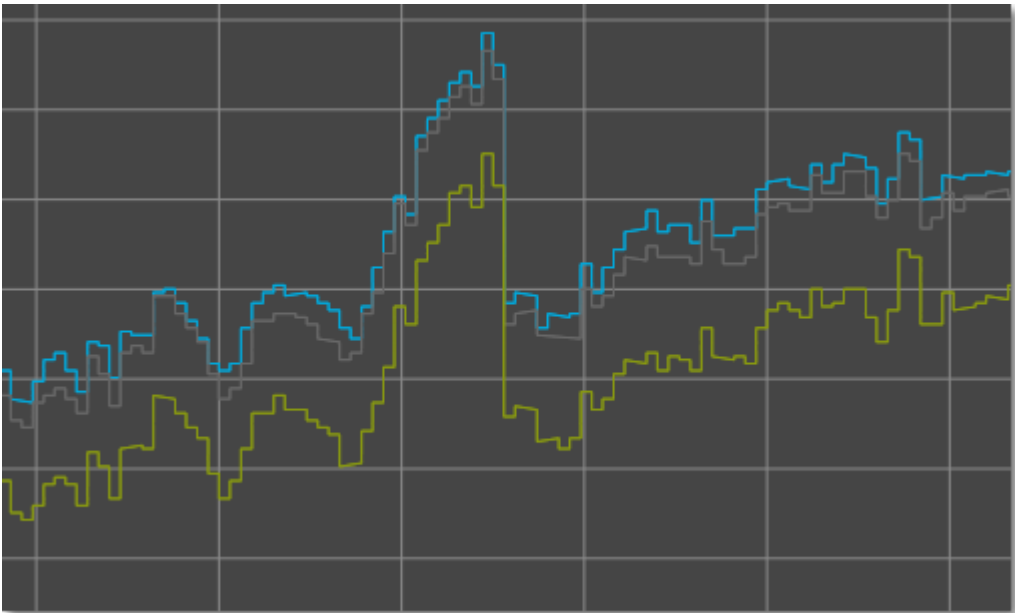

Add comments

With the "Add comment" option you can place as many text items in the graph as you want. When you click this option the following popup windows is shown:

Add Comment

Y Axis: Volts

Value: 0

X Axis Date: 09/29/2015 05:42:00 AM

Comment: [Empty text area]

OK Cancel

In this window you can enter where the text should be displayed and what text. The format of the date and time will be in the format as defined for the active language. Because the text is placed as a part of the graph it will stay in the correct position even when zooming in or out. Below you see an example of such a text item.

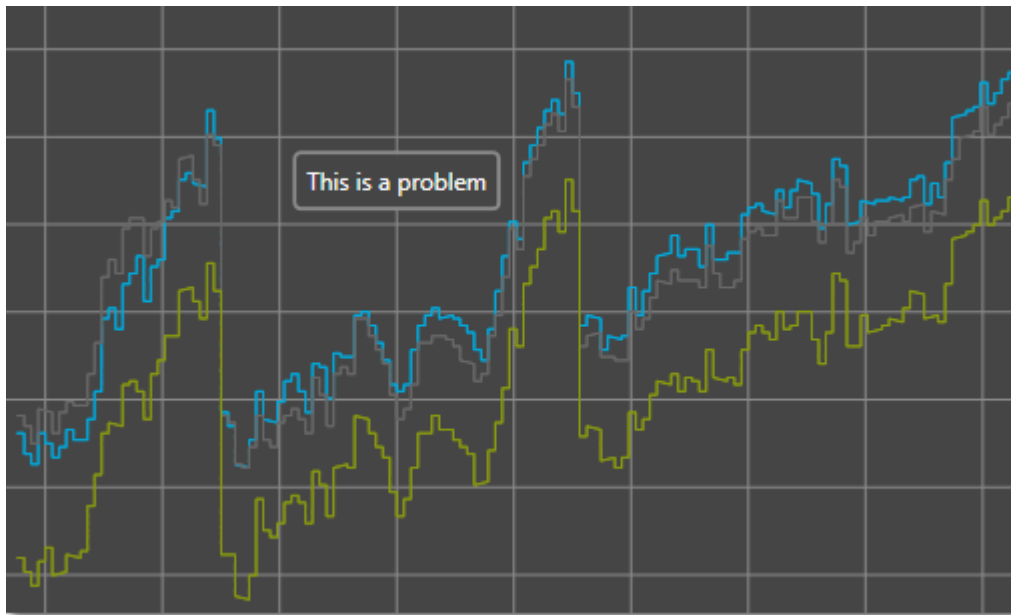

Auto scale

This option will reset all zooming and will return the graph to auto scale mode.

Screenshot

This will give you the option to save the current screen to a PNG file. This will include not only the graph but also all extra items like limit markers and comments.

Print

This will a 1 page report of the current graph including all extra items.

5.3.4 Power Quality Reports

The Power Quality module enables you to print out reports regarding the EN50160 standard. To be compliant with the standard you have to select at least days otherwise the report will always indicate that it is not compliant.

You can print 3 types of reports:

- A full EN50160 report
- A overview EN50160 report
- A user definable EN50160 report

The first will print all possible data with the addition of detail event information including a graph of the 10 ms and scope recorders if present. The second report will give you a quick overview regarding EN50160 and with the third report you can choose which parts of the report you want to print.

For the first and third option you need to take into account that printing the 10 ms and scope graph of an event takes approximately 30 to 50 seconds per event. This means of you have a lot of events and they all have 10 ms and scope recordings associated with them, printing these reports can take a long time.

5.3.5 Power Quality Events

With the events screen of the Power Quality module you can examine all events that have taken place and were recording by the device.

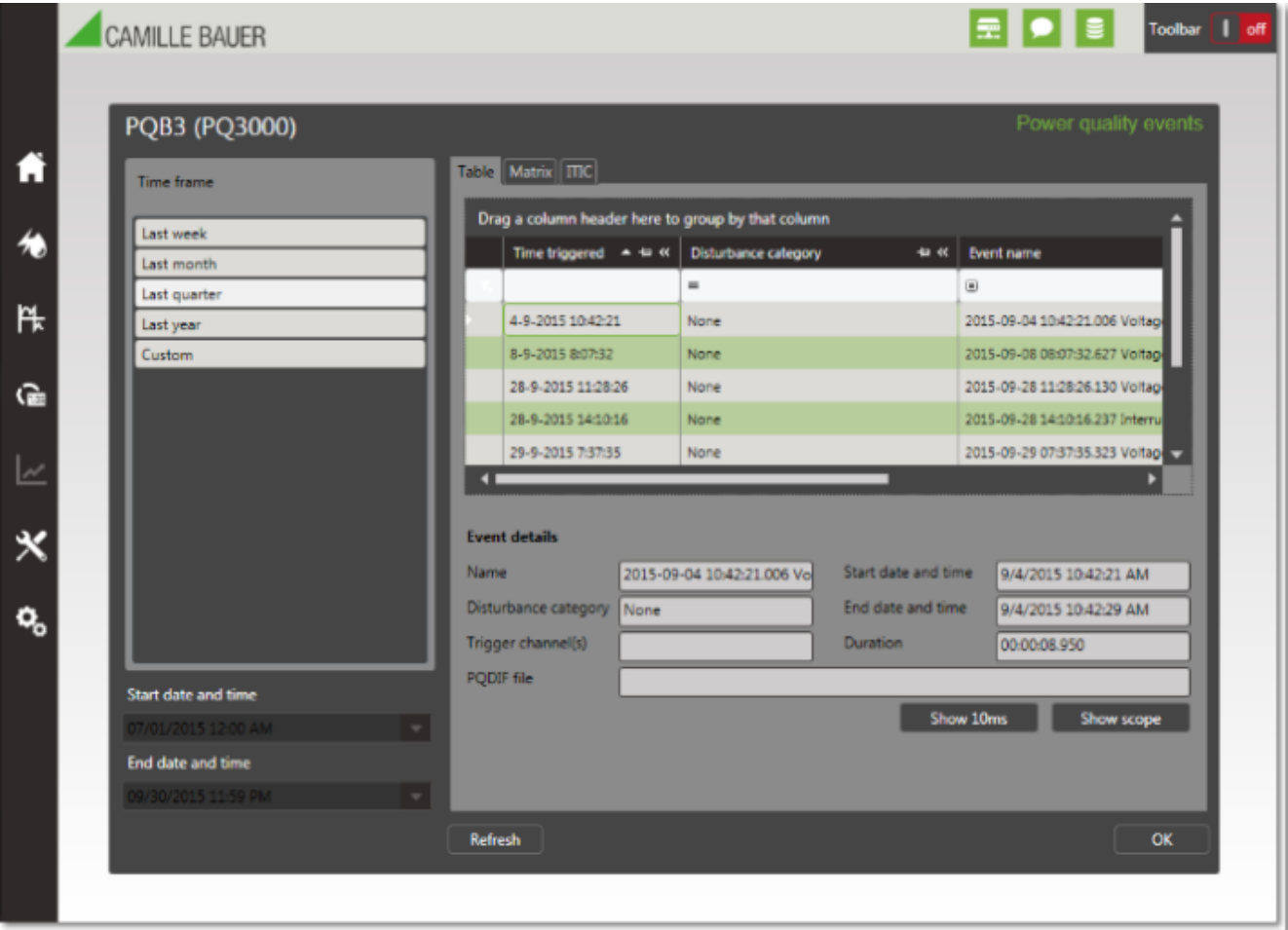

You select a time frame for which you want to see the events and the list is list with events is updated immediately. When you select an event you get more information regarding the event in the bottom part of the screen. It will also enable the buttons "Show 10ms" and "Show scope" if they are present for this particular event.

5.3.5.1 Power Quality 10 ms recordings

If an event has an associated 10 ms recording, this screen will visual the data in a graph.

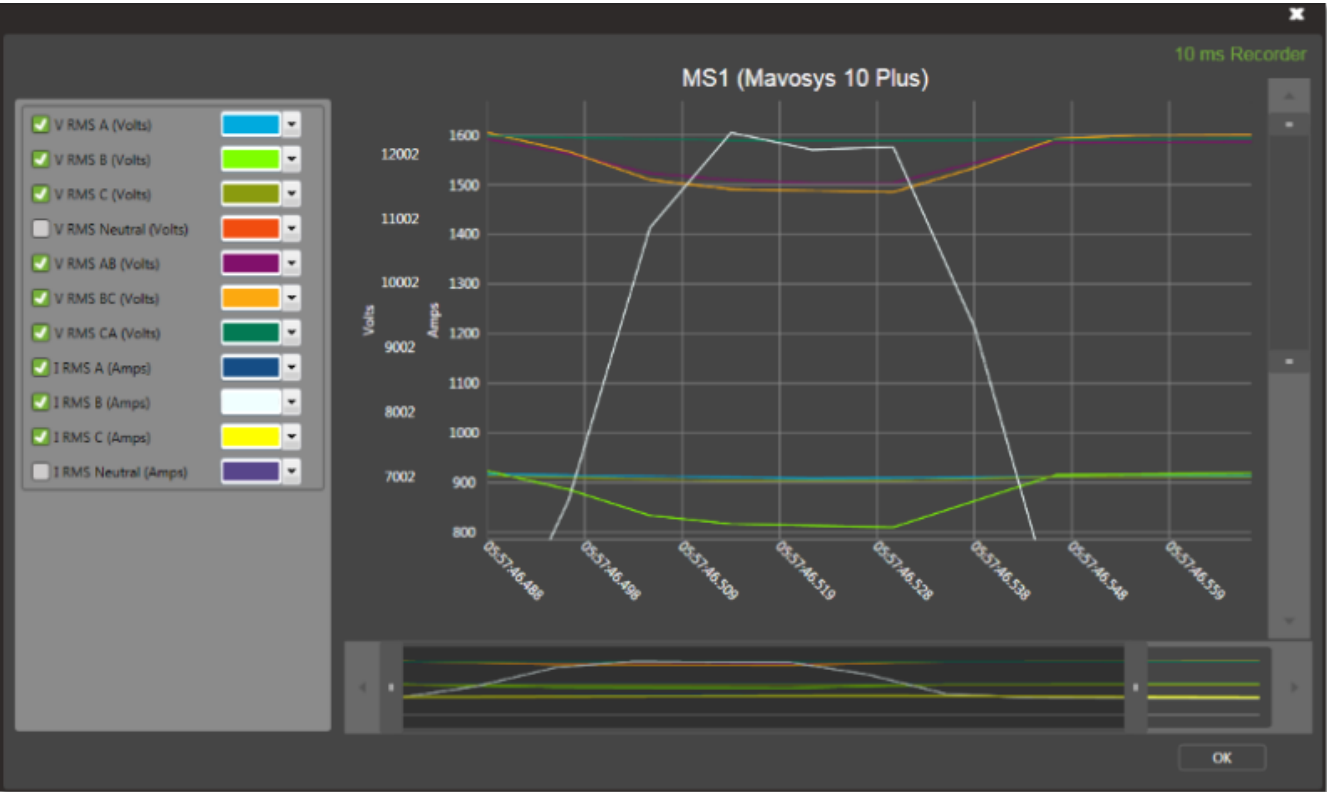

Legend

The legend will show you all measurements for whom data was found in the selected time frame. If a measurement you selected is not showing up in the legend, you know that there is no data for it. In the legend you can temporarily switch off one or more measurements, for instance to make a measurement you want a closer look at more visible. You can also change the line color of a measurement if you don't like the default color. Below a screenshot of a legend.

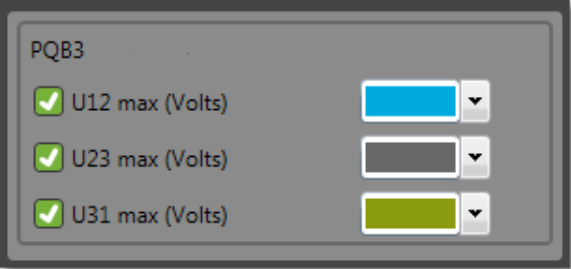

Zooming and panning

If you want to look in more detail to your graph you can zoom in three different ways. The first method is by using the so called zoombars at the bottom and on the right site of the screen. Below you see a screenshot of the horizontal zoombar.



The horizontal zoombar shows a thumbnail of your graph in the background to make positioning easier. You can change the zoom level by grabbing B or D and slide them left or right. The main graph is immediately updated. By grabbing C you can pan to the left or the right to quickly look at another part of the graph or you can click on A or E to move the view to the left or right. If you want to zoom out you can drag B to A and D to E or you select "Auto scale" in the toolbar or you right click on the graph and select zoom out.

The vertical zoombar works exactly the same off course but does not show a thumbnail of your graph.

The second method of zooming and panning is by using the mouse. You can drag a square over the graph and instantly the graph will zoom in to that area and the zoombars are synchronized. To pan to a different part of the graph you can hold down

the Alt key and then grab the graph and move it to where you want to go. The zoom out options are the same as mentioned before.
The third way is by holding your mouse cursor on the position you want to zoom in and use your scroll wheel to zoom in or out.
The toolbar options are the same as the toolbar in "Cyclic Data", see **here for more info (Section 5.3.3)**.

5.3.5.2 Power Quality Scope

If an event has an associated scope recording, this screen will visual the data in a graph.

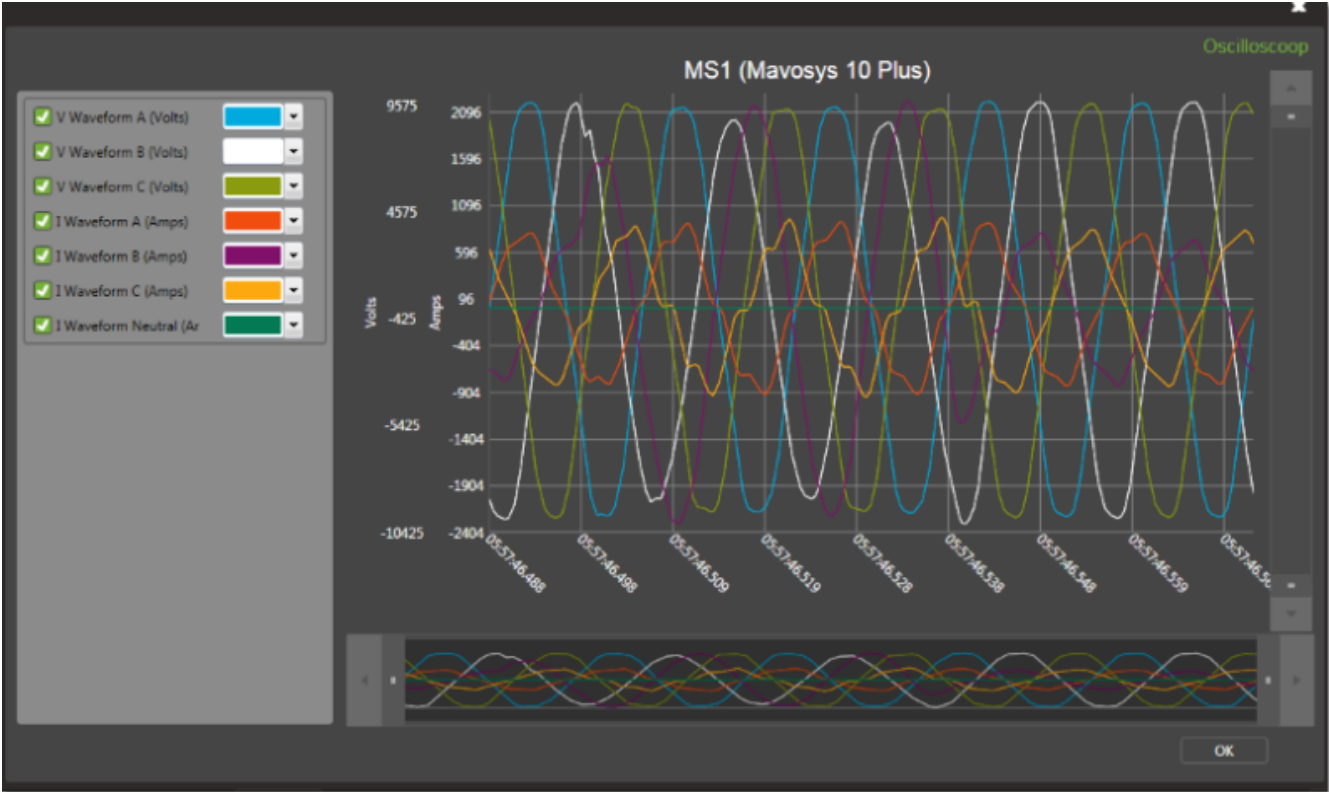

Legend

The legend will show you all measurements for whom data was found in the selected time frame. If a measurement you selected is not showing up in the legend, you know that there is no data for it. In the legend you can temporarily switch off one or more measurements, for instance to make a measurement you want a closer look at more visible. You can also change the line color of a measurement if you don't like the default color. Below a screenshot of a legend.

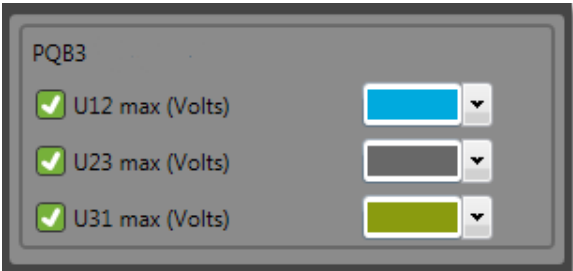

Zooming and panning

If you want to look in more detail to your graph you can zoom in three different ways. The first method is by using the so called zoombars at the bottom and on the right site of the screen. Below you see a screenshot of the horizontal zoombar.

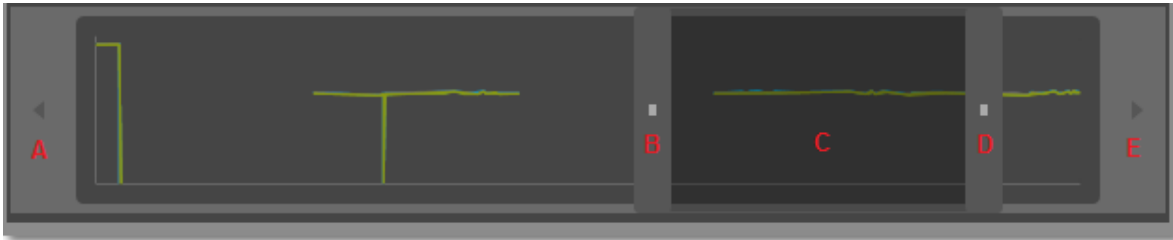

The horizontal zoombar shows a thumbnail of your graph in the background to make positioning easier. You can change the zoom level by grabbing B or D and slide them left or right. The main graph is immediately updated. By grabbing C you can pan to the left or the right to quickly look at another part of the graph or you can click on A or E to move the view to the left or right. If you want to zoom out you can drag B to A and D to E or you select "Auto scale" in the toolbar or you right click on the graph and select zoom out.

The vertical zoombar works exactly the same off course but does not show a thumbnail of your graph.

The second method of zooming and panning is by using the mouse. You can drag a square over the graph and instantly the graph will zoom in to that area and the zoombars are synchronized. To pan to a different part of the graph you can hold down the Alt key and then grab the graph and move it to where you want to go. The zoom out options are the same as mentioned before.

The third way is by holding your mouse cursor on the position you want to zoom in and use your scroll wheel to zoom in or out.

The toolbar options are the same as the toolbar in "Cyclic Data", see **here for more info (Section 5.3.3)**.

5.3.6 Power Quality Data Im/Export

With this screen you can import, export and delete imported PQDIF files.

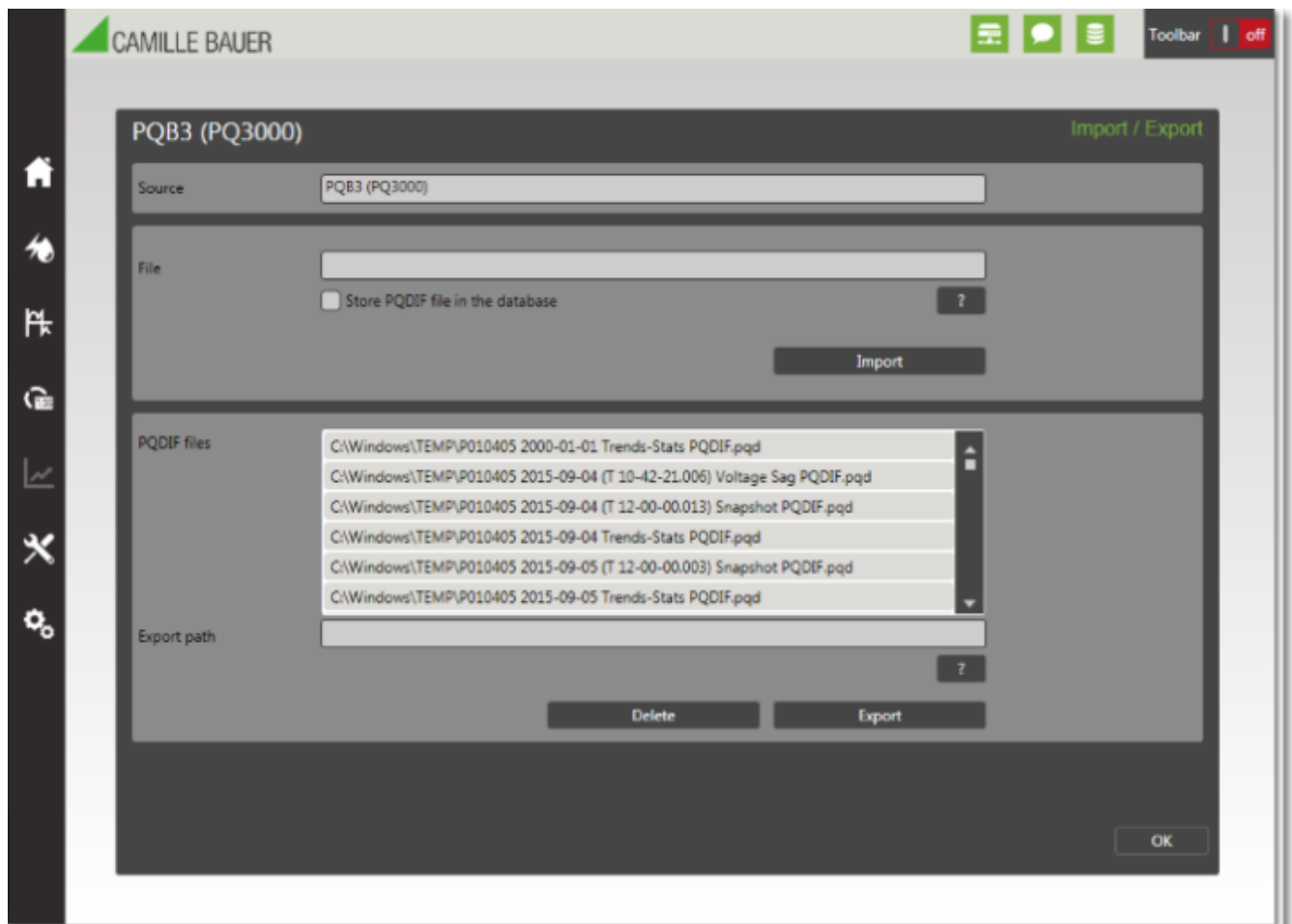

In the bottom part of the screen you see a list of imported PQDIF files. By selecting one you can either export it (if it was stored into the database during import) or you can delete it from the system. When you delete a file, all related data, that was created on import, is deleted as well.

The upper part of the screen can be used to import a PQDIF file manually. You click the "?" button to browse to the file you want to import and after clicking "OK" the selected file will be entered in the field "File". You can then select if you want to

store this file to the database as an archive or not. When you click "Import" the import will start and after a few moments a message box pops up indicating whether the import was successful or not and how many events were imported.

5.4 Scada

The Scada module can be used to visualize the data that is recorded by the SmartCollect Data Collection service. Creating and designing scada screens is very easy to do but still allows you to develop complex scada screens including navigation from one screen to another. This module consists of the following items:

- Administer the scada screens
- Designing scada screens
- Viewing scada screens
- List and graph possibilities in this module

The Scada is setup in SmartCollect differs a lot from the more expensive competitors. In SmartCollect a Scada screen always needs a background picture. This background picture can be created in other tools like MS Paint, Adobe Photoshop or Illustrator or any image design tool. In the designer of the Scada module you can then place controls on top of this background image and these controls can be configured to show realtime values of the measurements collected by the SmartCollect service.

Because of the use of a background image instead of designing the whole screen in SmartCollect itself, the software is easier to use and less expensive to buy.

Layers

When adding controls to the design surface you should know that the design surface has 3 layers. You can see these layers but every control is programmed to be automatically added to one of these layers.

The first layer is for images, the second layer is for hotspots and the third layer is for all other controls.

This means that when you add an image control, a device icon, a device image or an image from the other images option of the toolbar, they will all be added to the first layer (the lowest layer) of the design surface. If you add a hotspot it will always be added to the second layer and all other controls will be added to the third layer (the highest layer).

The reason for this has to do with what a user can do with a control when viewing a Scada screen. With images a user can not do anything and that is why they are shown at the first and lowest layer. With a hotspot a user can navigate and they are on the second layer. If this was the other way around, meaning hotspot on the first and image on the second layer, it could happen that a image is partially or completely covering a hotspot making it impossible to click on the hotspot. Since hotspots are transparent when viewing a screen, it is no problem that a hotspot covers an image. The image is still visible and the hotspot is still clickable.

All other controls are placed on the third and highest layer and can always be clicked on to display a graph of the last twenty four hours.

5.4.1 Administer Scada Screens

To administer Scada screens you go to Scada --> Configuration --> Screens and the following screen is showed.

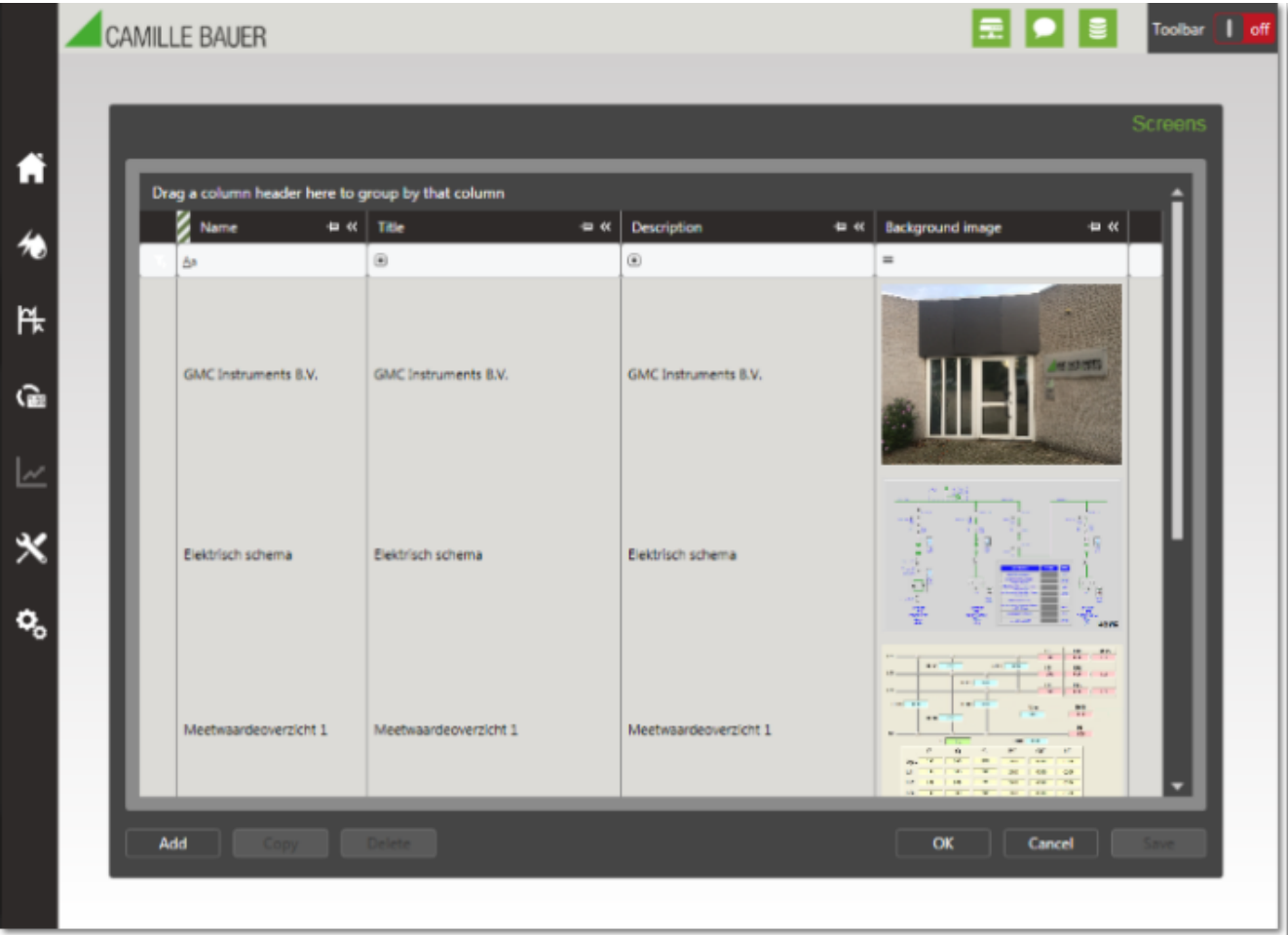

In this screen you can add, delete or update the basic info of a Scada screen and the background image that is used for such a screen. The following screenshot shows the popup windows that is used to enter a new screen into the system.

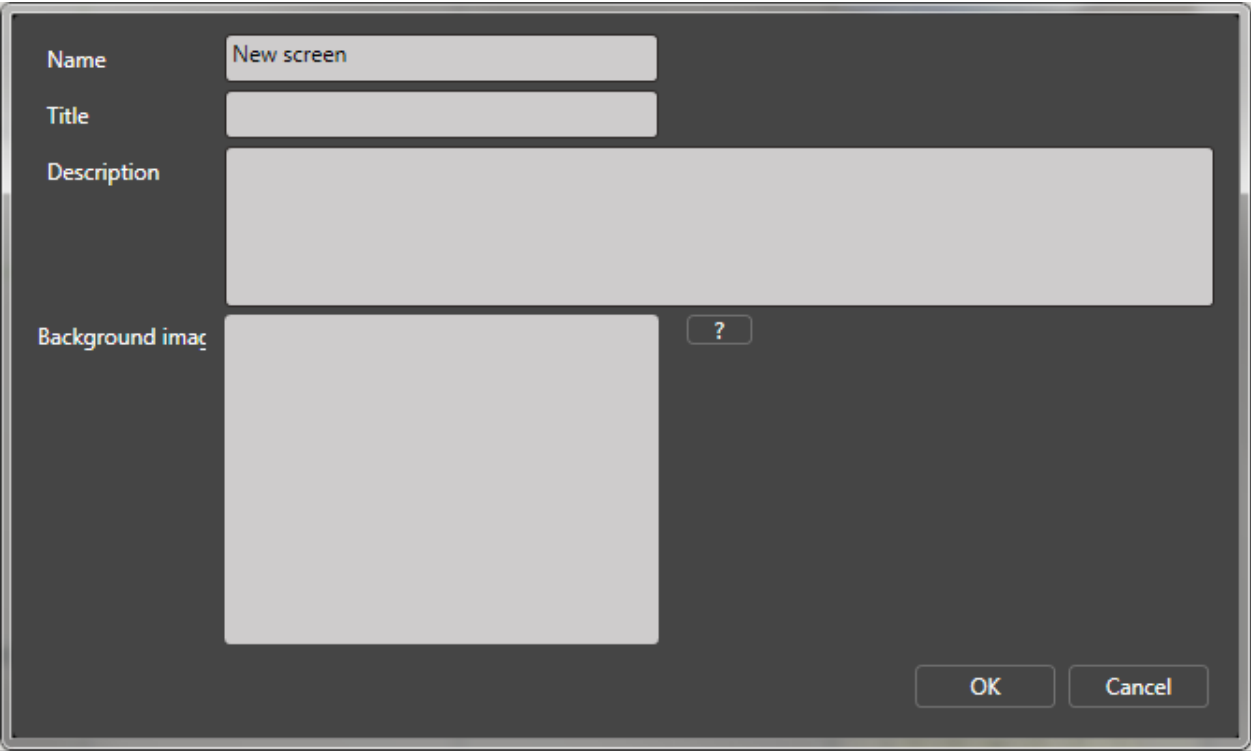

In the table below the fields of this screen are explained.

Field name	Description
Name	An identification of the screen.
Title	The title is used by the user to select a certain screen from the menu.
Description	The description is now used except in this screen. It is only there as a possibility to add some comments to the screen.
Background image	The background image that is used for this screen. You select a file from disk by clicking the "?". Once a file is selected it will be uploaded to the database and the file on disk is no longer used.

5.4.2 Designing Scada Screens

To design Scada screens you go to Scada --> Configuration --> Designer and the following screen is showed.

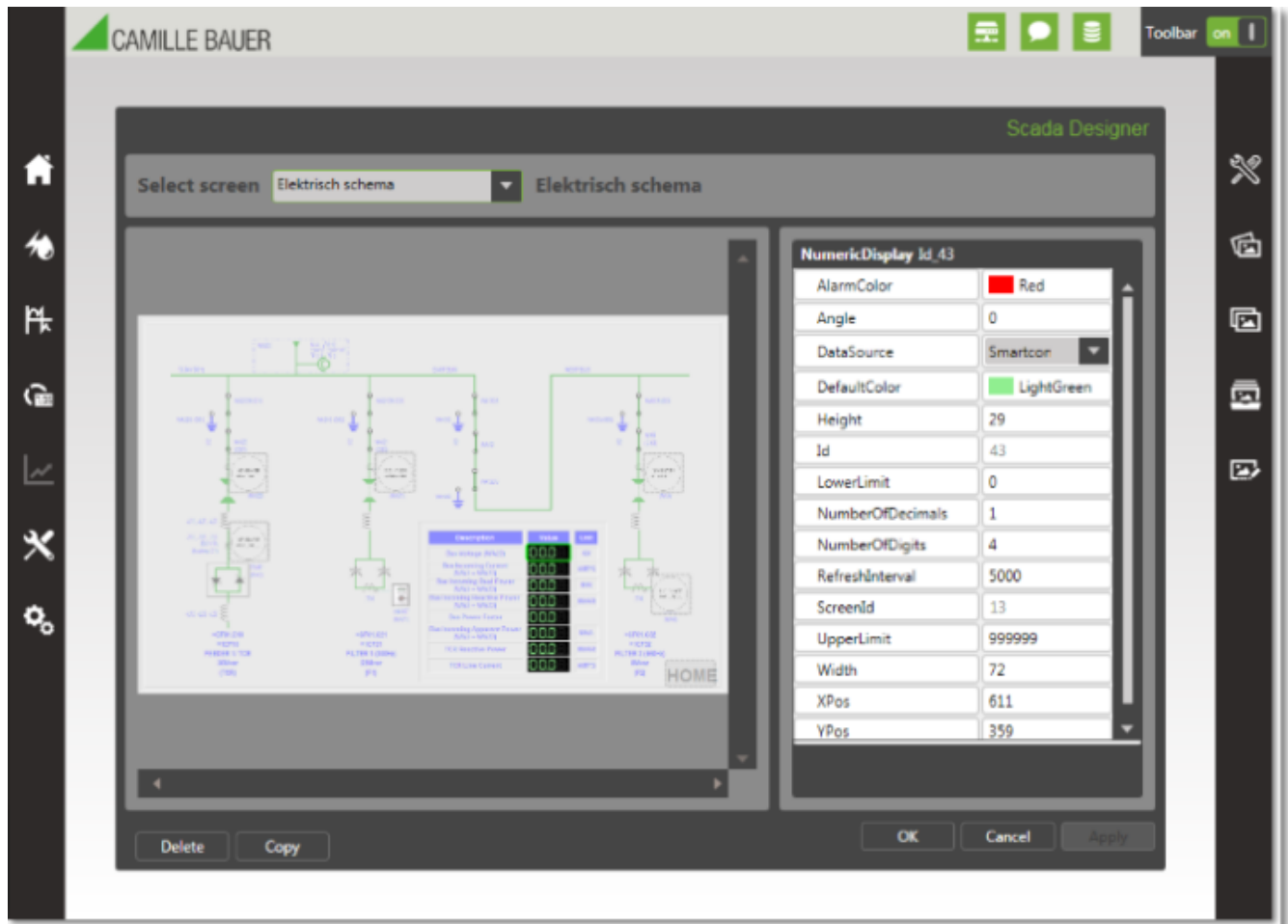

This screenshot shows an example of a Scada screen. In the top the screen you select which screen you want to design, currently a screen called "PV" is selected. The main part of the screen shows you the design surface with the controls you added to the screen. In this example there already a few numeric display controls added and some other type of controls.

To add a new control you go with your mouse to the right site of the screen and the toolbar, with all of the options for this particular screen, will slide out. The toolbar has the following option:

Option	Description
Design controls	This option shows you all the controls that are available and that you can add to the currently selected screen. An explanation of every individual control is provide here (Section 5.4.3) .
Device icons	This option gives you a list of icons of all Camille Bauer and Gossen Metrawatt devices that you can use in your design.
Device images	This option gives you a list of images of all Camille Bauer and

Option	Description
Other images	Gossen Metrawatt devices that you can use in your design. This option gives you a list of images that are present in a predefined location. You can set this location in Configuration (Section 5.6.1) with the parameter "ScadaImagePath". If you add a picture to this directory while you are inside the designer, you can refresh the list by a double click on the text "Other images".
Edit background	When you want to change the background image used by a screen you can of course edit the original file and then use the Screens (Section 5.4.1) menu to select the changed file. But you also can use this option to open the background of the currently selected screen in Microsoft Paint and edit it there. Once you leave Paint and save the image, the image will be re-imported into the database and the designer is updated.

To add a control to the design surface you hover your mouse over the option "Design controls" and the submenu containing all the controls is shown. You then click the control you want to add and the new control is placed on the upper left corner of the screen. You can then drag it to any position you like.

Using drag and drop to place a control is not very accurate and to "fine-tune" the placement of a control you can use the control properties. When you click a control it will show a green border indicating that it is the currently active control and the properties supported by the control are shown in the property grid on the right side of the screen. For accurate placement of a control you can use the XPos and YPos properties that are set on a pixel based value. Here you can change the location pixel for pixel if you want until you are satisfied with the location.

5.4.3 Design Controls

The SmartCollect Scada designer supports the following controls, in order they appear in the toolbar:

- **Date and time (Section 5.4.3.1)**
- **Graph (Section 5.4.3.2)**
- **Hotspot (Section 5.4.3.3)**
- **Image (Section 5.4.3.4)**
- **Level indicator (Section 5.4.3.5)**
- **Numeric display (Section 5.4.3.6)**
- **Push button (Section 5.4.3.7)**
- **Radial gauge (Section 5.4.3.8)**
- **State led (Section 5.4.3.9)**
- **Electrical switch (Section 5.4.3.10)**
- **Text element (Section 5.4.3.11)**
- **Toggle switch (Section 5.4.3.12)**
- **Value display (Section 5.4.3.13)**

Every control will be discussed in a separate topic. You can click on a control in the list above to navigate to the topic of that particular control.

5.4.3.1 Date and time control

The date and time control can be used to display date and/or time on a scada screen. This might be useful when running Scada screens full screen in the Scada Runtime Client because then you will not see the Windows taskbar and therefore not the date and time display there.

By default the control looks like below:

12-11-2015 9:46:06

In this case it is the default date and time as defined by the Dutch regional settings of Windows. However the format of the date and time can be altered to anything you want by changing the DateTimeFormat property. Below is a screenshot of the properties available for this control:

DateTimeElement New_2	
Angle	0
DateTimeFormat	d-M-yyyy H:mm:ss
DefaultColor	Black
FontName	Verdana
Height	25
Id	0
ScreenId	0
TextSize	10
TimeOffset	0
Width	125
XPos	106
YPos	142

In the table below the properties of this control are explained:

Property

Angle
DateTimeFormat

Description

This property changes the angle of the control.

You can use this property to display the date and/or time in any format you like.

Valid characters are:

d	The day of the month, from 1 through 31.
dd	The day of the month, from 01 through 31.
ddd	The abbreviated name of the day of the week.
dddd	The full name of the day of the week.
f	The tenths of a second in a date and time value.
ff	The hundredths of a second in a date and time value.
fff	The ten thousandths of a second in a date and time value.
F	If non-zero, the tenths of a second in a date and time value.
FF	If non-zero, the hundredths of a second in a date and time value.
FFF	If non-zero, the milliseconds in a date and time value.
h	The hour, using a 12-hour clock from 1 to 12.
hh	The hour, using a 12-hour clock from 01 to 12.
H	The hour, using a 24-hour clock from 0 to 23.
HH	The hour, using a 24-hour clock from 00 to 23.
m	The minute, from 0 through 59.
mm	The minute, from 00 through 59.
M	The month, from 1 through 12.
MM	The month, from 01 through 12.
MMM	The abbreviated name of the month.

Property	Description
DefaultColor	With this option you can change the color.
FontName	With this option you can change the font type.
Height	With this option you can change the height of the control. It will not change the fontsize.
Id	A read-only property that shows the id that is used to store this control in the database.
ScreenId	A read-only property that shows the id of the screen this control belongs to.
TextSize	With this property you can change the font size.
TimeOffset	This property can be used to add or subtract a certain number of hours from the current time. This way you can show the time from a different timezone.
Width	With this option you can change the width of the control. It will not change the fontsize.
XPos	With this option you can alter the x position of the control.
YPos	With this option you can alter the y position of the control.

5.4.3.2 Graph control

The graph control can be used to display a maximum of 3 lines in a graph.

By default the control looks like below:

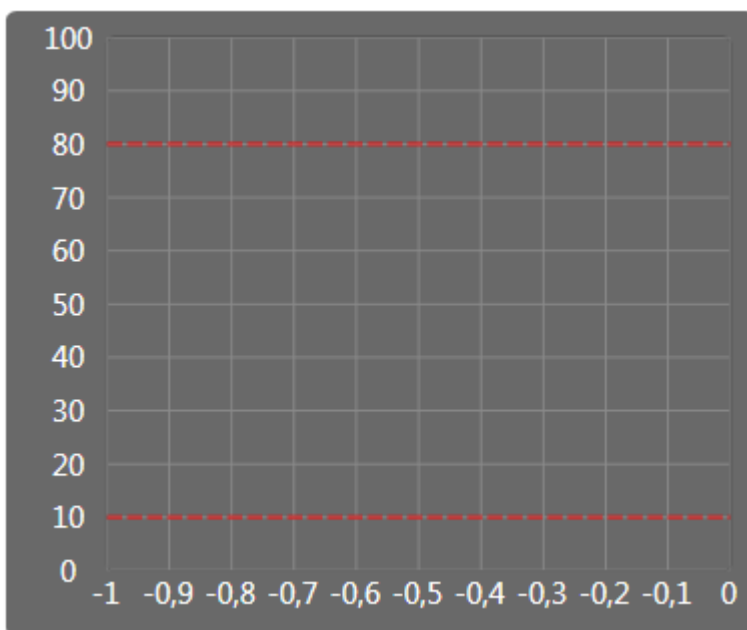

Below is a screenshot of the properties available for this control:

GraphElement New_3	
Angle	0
BackgroundColor	DimGray
DataSource1	<None>
DataSource2	<None>
DataSource3	<None>
FontName	Verdana
ForegroundColor	White
GraphPeriod	OneHour
Height	250
Id	0
LimitColor	Red
Line1Color	Aqua
Line2Color	Chartreuse
Line3Color	Coral
LowerLimit	10
MaxValue	100
MinValue	0
RefreshInterval	5000
ScreenId	0
TextSize	14
Title	
UpperLimit	80
Width	300
XPos	10
YPos	10

In the table below the properties of this control are explained:

Property

Angle
 BackgroundColor
 DataSource1
 DataSource2
 DataSource3
 FontName

Description

This property changes the angle of the control.
 This property changes the background color of the control.
 With this property you select which value is shown in the first line of the graph.
 With this property you select which value is shown in the second line of the graph. If you select <none> than of course the line is not shown.
 With this property you select which value is shown in the third line of the graph. If you select <none> than of course the line is not shown.
 With this option you can change the font type.

Property	Description
ForegroundColor	This property changes the foreground color of the control.
GraphPeriod	This property changes the time frame of the graph. By default it is set to <code>OneHour</code> , meaning all values from 1 hour ago until now are shown in the graph. You have the following options: <ul style="list-style-type: none"> • <code>OneHour</code> • <code>ThreeHours</code> • <code>TwelveHours</code> • <code>TwentyFourHours</code>
Height	With this option you can change the height of the control.
Id	A read-only property that shows the id that is used to store this control in the database.
LimitColor	This property changes the color that is used to display the limit markers.
LineColor1	This property changes the color that is used to display the first line of the graph.
LineColor2	This property changes the color that is used to display the second line of the graph.
LineColor3	This property changes the color that is used to display the third line of the graph.
LowerLimit	This property can be used to display or hide the lower limit marker. When you enter a value of zero the limit marker is hidden, any other value will show the limit marker on the set value.
MaxValue	This property changes the maximum value shown on the Y axis.
MinValue	This property changes the minimum value shown on the Y axis.
RefreshInterval	This property determines at which interval the data is retrieved from the database and thereby refreshing the graph. The default value is 5 seconds but if the data shown in the graph is only collected, for instance, every 5 minutes, there is now point in getting the data from the database at such a high interval. In that case an <code>RefreshInterval</code> of 1 or even 5 minutes makes more sense.
ScreenId	A read-only property that shows the id of the screen this control belongs to.
TextSize	With this property you can change the font size.
Title	This property can be used to add a title to the graph.
UpperLimit	This property can be used to display or hide the upper limit marker. When you enter a value of zero the limit marker is hidden, any other value will show the limit marker on the set value.
Width	With this option you can change the width of the control.
XPos	With this option you can alter the x position of the control.
YPos	With this option you can alter the y position of the control.

5.4.3.3 Hotspot control

The hotspot control is a special control. This control will not show you any values and can be used for 2 things. First you can use it to open external documents. This documents can be anything you like, from PDF's containing a manual to websites with product information. The only restriction is that Windows knows how to open such a document.

The second, and more important, use of this control is to navigate to another Scada screen, allowing you to build a

navigation system into your Scada screen. If, for example, you have a main screen with several device icons on it representing the devices in your installation. You can than place a hotspot over such an icon an set the NavigateToScreen property to a Scada screen showing the detailed information of that particular device. If you than add a "Home" or "Back" image to that sub screen and place a hotspot over that image you can set it to navigate back to the main screen again. This way you can build your own visualization application with as much screens as you want.

Only during designing the screen is the control shown as below. During runtime the control is completely invisible but when you hoover your mouse over the location of the control the mouse pointer will change indicating that you can navigate to a document or Scada screen.

By default the control looks like below:



Below is a screenshot of the properties available for this control:

HotSpot New_5	
Angle	0
Height	100
Id	0
NavigateToDocument	
NavigateToScreen	
ScreenId	0
Width	100
XPos	64
YPos	123

In the table below the properties of this control are explained:

Property	Description
Angle	This property changes the angle of the control.
Height	With this option you can change the height of the control. It will not change the fontsize.
Id	A read-only property that shows the id that is used to store this control in the database.
NavigateToDocument	This property sets the document that will be opened when the user clicks on the control during runtime.
NavigateToScreen	This property sets the screen that will be navigated to when the user clicks on the control during runtime.
ScreenId	A read-only property that shows the id of the screen this control belongs to.
Width	With this option you can change the width of the control. It will not change the fontsize.
XPos	With this option you can alter the x position of the control.
YPos	With this option you can alter the y position of the control.

5.4.3.4 Image control

The image control can be used to display any type of image you have stored on disk on the Scada screen. Because this image is not stored in the database you have to make sure that the path of this image is accessible for other users of this Scada screen as well.

By default the control looks like below:



Below is a screenshot of the properties available for this control:

ImageElement New_6	
Angle	0
Height	150
Id	0
ScreenId	0
Source	<input type="text" value=""/> ?
Width	150
XPos	168
YPos	121

In the table below the properties of this control are explained:

Property	Description
Angle	This property changes the angle of the control.
Height	With this option you can change the height of the control. It will not change the fontsize.
Id	A read-only property that shows the id that is used to store this control in the database.
ScreenId	A read-only property that shows the id of the screen this control belongs to.
Source	This property sets the path and filename of the image.
Width	With this option you can change the width of the control. It will not change the fontsize.
XPos	With this option you can alter the x position of the control.
YPos	With this option you can alter the y position of the control.

5.4.3.5 Level indicator control

The level indicator control can be used in more than one way. The main purpose of the control is to indicate a level

of liquid in a tank, but if you put several of these controls side by side you can create a bar graph with it. You can also use it as an output indicator when for example measuring sound.

By default the control looks like below:



Below is a screenshot of the properties available for this control:

LevelIndicator New_7	
AlarmColor	■ Red
Angle	-90
DataSource	<None> ▼
DefaultColor	■ Green
Height	25
Id	0
LowerLimit	0
MaxValue	100
MinValue	0
RefreshInterval	5000
ScreenId	0
UpperLimit	80
Width	70
XPos	264
YPos	186

In the table below the properties of this control are explained:

Property

AlarmColor

Angle

DataSource

DefaultColor

Height

Id

LowerLimit

Description

This property changes the foreground color of the control to the selected color when the value of the shown measurement exceeds the upper or lower limit.

This property changes the angle of the control.

With this property you select which value is shown in this control.

This property sets the foreground color of the control.

With this option you can change the height of the control.

A read-only property that shows the id that is used to store this control in the database.

When the current value of the measurement shown in the control drops below the value set in this property, it will change the foreground color of the control to the alarm color.

Property	Description
MaxValue	This property sets the maximum value shown in the control.
MinValue	This property sets the minimum value shown in the control.
RefreshInterval	This property determines at which interval the data is retrieved from the database and thereby refreshing the control. The default value is 5 seconds but if the data shown in the control is only collected, for instance, every 5 minutes, there is now point in getting the data from the database at such a high interval. In that case an RefreshInterval of 1 or even 5 minutes makes more sense.
ScreenId	A read-only property that shows the id of the screen this control belongs to.
UpperLimit	When the current value of the measurement shown in the control exceeds the value set in this property, it will change the foreground color of the control to the alarm color.
Width	With this option you can change the width of the control.
XPos	With this option you can alter the x position of the control.
YPos	With this option you can alter the y position of the control.



5.4.3.6 Numeric display control

The numeric display is used to show a value in a Scada screen and is probably the most used control.

By default the control looks like below:



Below is a screenshot of the properties available for this control:

NumericDisplay New_8	
AlarmColor	 Red
Angle	0
DataSource	<None> ▼
DefaultColor	 LightGreen
Height	30
Id	0
LowerLimit	0
NumberOfDecimals	1
NumberOfDigits	4
RefreshInterval	5000
ScreenId	0
UpperLimit	999999
Width	70
XPos	220
YPos	180

In the table below the properties of this control are explained:

Property

AlarmColor

Angle

DataSource

DefaultColor

Height

Id

LowerLimit

NumberOfDecimals

NumberOfDigits

RefreshInterval

ScreenId

UpperLimit

Description

This property changes the foreground color of the control to the selected color when the value of the shown measurement exceeds the upper or lower limit.

This property changes the angle of the control.

With this property you select which value is shown in this control.

This property sets the foreground color of the control.

With this option you can change the height of the control.

A read-only property that shows the id that is used to store this control in the database.

When the current value of the measurement shown in the control drops below the value set in this property, it will change the foreground color of the control to the alarm color.

This property sets the number of decimals shown in the control.

This property sets the maximum number of digits the control can show.

This property determines at which interval the data is retrieved from the database and thereby refreshing the control. The default value is 5 seconds but if the data shown in the control is only collected, for instance, every 5 minutes, there is now point in getting the data from the database at such a high interval. In that case an RefreshInterval of 1 or even 5 minutes makes more sense.

A read-only property that shows the id of the screen this control belongs to.

When the current value of the measurement shown in the

Property

Description

Width
XPos
YPos

control exceeds the value set in this property, it will change the foreground color of the control to the alarm color.
With this option you can change the width of the control.
With this option you can alter the x position of the control.
With this option you can alter the y position of the control.

5.4.3.7 Push button control

The push button is a control that doesn't show a value but can trigger an action. The control will only be available if the add-on "Actions" is enabled in your license. If you want to read more about actions, please read this topic.

By default the control looks like below:



Below is a screenshot of the properties available for this control:

PushButton New_9	
Action	<input type="text" value=""/>
Angle	0
Color	<input type="color" value="Gray"/>
FontName	Verdana
Height	60
Id	0
ScreenId	0
Text	Button
TextColor	White
TextSize	10
Width	60
XPos	161
YPos	196

In the table below the properties of this control are explained:

Property

Description

Action
Angle
Color

This property sets the action that will be executed when a user clicks the control during runtime.
This property changes the angle of the control.
With this property you select the color of this control.

Property	Description
FontName	This property sets the font type used to show the text of the control.
Height	With this option you can change the height of the control.
Id	A read-only property that shows the id that is used to store this control in the database.
ScreenId	A read-only property that shows the id of the screen this control belongs to.
Text	This property sets the text that is displayed on the control.
TextColor	This property sets the color of the text that is displayed on the control.
TextSize	This property sets the size of the text that is displayed on the control.
Width	With this option you can change the width of the control.
XPos	With this option you can alter the x position of the control.
YPos	With this option you can alter the y position of the control.

5.4.3.8 Radial gauge control

The radial gauge control is analogue display of a value.

By default the control looks like below:

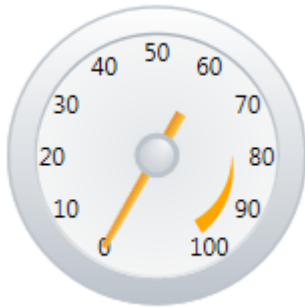

Below is a screenshot of the properties available for this control:

RadialGauge New_10	
AlarmColor	■ Red
Angle	0
DataSource	<None> ▼
DefaultColor	■ LightGreen
Id	0
LowerLimit	80
MaxValue	100
MinValue	0
RefreshInterval	5000
ScreenId	0
Size	117
UpperLimit	100
XPos	208
YPos	145

In the table below the properties of this control are explained:

Property

AlarmColor
 Angle
 DataSource
 DefaultColor
 Id
 LowerLimit
 MaxValue
 MinValue
 RefreshInterval
 ScreenId
 Size
 UpperLimit
 XPos
 YPos

Description

This property changes the color of the marker that is shown below the values 80 till 100 (in the above example).

This property changes the angle of the control.

With this property you select which value is shown in this control.

This property is not used at this moment.

A read-only property that shows the id that is used to store this control in the database.

This value sets the start of the marker that is shown below the values 80 till 100 (in the above example).

This property sets the maximum value shown in the control.

This property sets the minimum value shown in the control.

This property determines at which interval the data is retrieved from the database and thereby refreshing the control. The default value is 5 seconds but if the data shown in the control is only collected, for instance, every 5 minutes, there is now point in getting the data from the database at such a high interval. In that case an RefreshInterval of 1 or even 5 minutes makes more sense.

A read-only property that shows the id of the screen this control belongs to.

With this option you can change the size of the control.

This value sets the end of the marker that is shown below the values 80 till 100 (in the above example).

With this option you can alter the x position of the control.

With this option you can alter the y position of the control.

5.4.3.9 State led control

The state led control is a simple control that will change color based on the value of the connected measurement. By default the color will be the default color as long as the value is \leq zero and the alarm color is shown when the value is $>$ zero. You can flip the colors shown by selecting the option "OnIsOk".

By default the control looks like below:



Below is a screenshot of the properties available for this control:

StateLed New_8	
AlarmColor	■ Red
DataSource	<None> ▼
DefaultColor	■ Green
Id	0
OnIsOk	<input type="checkbox"/>
RefreshInterval	5000
ScreenId	0
Size	35
XPos	10
YPos	10

In the table below the properties of this control are explained:

Property	Description
AlarmColor	This property sets the color of the control that is used when the value is outside its limit.
DataSource	With this property you select which value is used in this control.
DefaultColor	This property sets the color of the control that is used when the value is inside its limit.
Id	A read-only property that shows the id that is used to store this control in the database.
OnIsOk	By default any value larger than zero is interpreted as outside the limit and any value equal to or less than zero is within the limit. When selecting this option the conditions are reversed.
RefreshInterval	This property determines at which interval the data is retrieved from the database and thereby refreshing the control. The default value is 5 seconds but if the data shown in the control is only collected, for instance, every 5 minutes, there is no point in getting the data from the database at such a high interval. In that case a RefreshInterval of 1 or even 5 minutes makes more sense.
ScreenId	A read-only property that shows the id of the screen this control belongs to.
Size	With this option you can change the size of the control.
XPos	With this option you can alter the x position of the control.

Property

YPos

Description

With this option you can alter the y position of the control.

5.4.3.10 Electrical switch control

The electrical switch control can be used in electro-technical schematics the show the position of a switch. You can set the angles of the open and closed position of the switch to match your schematic. By default the closed state is interpreted as the correct state and the switch will be the default color and the switch will change to the alarm color when it is open. but You can flip the colors shown by selecting the option "OnIsOk".

By default the control looks like below:



Below is a screenshot of the properties available for this control:

SwitchElectrical New_9	
AlarmColor	■ Red
AngleClosed	0
AngleOpen	45
DataSource	<None> ▼
DefaultColor	■ Green
Id	0
IsOpen	<input type="checkbox"/>
OpenIsOk	<input type="checkbox"/>
RefreshInterval	5000
ScreenId	0
Size	100
XPos	10
YPos	10

In the table below the properties of this control are explained:

Property

AlarmColor

Description

This property sets the color of the control when it is in the alarm state.

AngleClosed

This property sets the angle of the switch in the closed state.

AngleOpen

This property sets the angle of the switch in the open state.

DataSource

With this property you select which value is used in this control.

DefaultColor

This property sets the color of the control when it is in the normal state.

Id

A read-only property that shows the id that is used to store this control in the database.

Property	Description
IsOpen	This property determines if the control starts in the open or closed state.
OnIsOk	By default any value larger than zero is interpreted as outside the limit and any value equal to or less than zero is within the limit. When selecting this option the conditions are reversed.
RefreshInterval	This property determines at which interval the data is retrieved from the database and thereby refreshing the control. The default value is 5 seconds but if the data shown in the control is only collected, for instance, every 5 minutes, there is no point in getting the data from the database at such a high interval. In that case an RefreshInterval of 1 or even 5 minutes makes more sense.
ScreenId	A read-only property that shows the id of the screen this control belongs to.
Size	With this option you can change the size of the control.
XPos	With this option you can alter the x position of the control.
YPos	With this option you can alter the y position of the control.

5.4.3.11 Text element control

The text element control can be used to put a text in the Scada screen.

By default the control looks like below:

TextElement

Below is a screenshot of the properties available for this control:

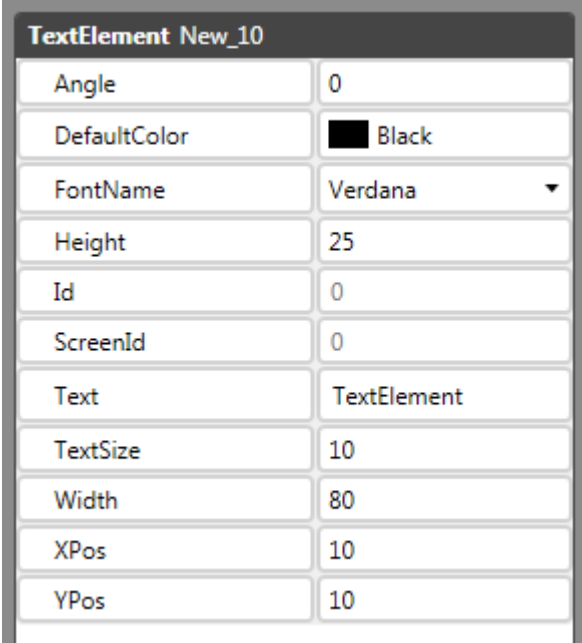

Property	Value
Angle	0
DefaultColor	Black
FontName	Verdana
Height	25
Id	0
ScreenId	0
Text	TextElement
TextSize	10
Width	80
XPos	10
YPos	10

In the table below the properties of this control are explained:

Property	Description
Angle	This property changes the angle of the control.
DefaultColor	With this option you can change the color.
FontName	With this option you can change the font type.

Property	Description
Height	With this option you can change the height of the control. It will not change the fontsize.
Id	A read-only property that shows the id that is used to store this control in the database.
ScreenId	A read-only property that shows the id of the screen this control belongs to.
Text	Sets the text to display.
TextSize	With this property you can change the font size.
Width	With this option you can change the width of the control. It will not change the fontsize.
XPos	With this option you can alter the x position of the control.
YPos	With this option you can alter the y position of the control.

5.4.3.12 Toggle switch control

The toggle switch is a control that doesn't show a value but can trigger two actions, one when going from on to off and one when going from off to on. The control will only be available if the add-on "Actions" is enabled in your license. If you want to read more about actions, please read this topic.

By default the control looks like below:



Below is a screenshot of the properties available for this control:

ToggleSwitch New_11	
Angle	0
Height	40
Id	0
InitialStateIsOn	<input checked="" type="checkbox"/>
OffAction	
OffBackgroundColor	■ Red
OnAction	
OnBackgroundColor	■ LawnGreen
ScreenId	0
TextOff	Off
TextOn	On
Width	80
XPos	10
YPos	10

In the table below the properties of this control are explained:

Property	Description
Angle	This property changes the angle of the control.
Height	With this option you can change the height of the control.
Id	A read-only property that shows the id that is used to store this control in the database.
InitialStateIsOn	With this property you select whether the control is in its on or off position at startup of the screen.
OffAction	This property sets the action that will be executed when the going from on to off during runtime.
OffBackgroundColor	This property sets the background color of the off position of the switch.
OnAction	This property sets the action that will be executed when the going from off to on during runtime.
OnBackgroundColor	This property sets the background color of the on position of the switch.
ScreenId	A read-only property that shows the id of the screen this control belongs to.
TextOff	This property sets the text that is displayed in the off position of the control.
TextOn	This property sets the text that is displayed in the on position of the control.
Width	With this option you can change the width of the control.
XPos	With this option you can alter the x position of the control.
YPos	With this option you can alter the y position of the control.

5.4.3.13 Value display control

The value display is used to show a value in a Scada screen including the unit as configured with the channel associated with the control in any font and size you want.

By default the control looks like below:



Below is a screenshot of the properties available for this control:

ValueDisplay New_12	
AlarmColor	■ Red
Angle	0
BackgroundColor	White
DataSource	<None> ▼
DefaultColor	■ Black
FontName	Verdana ▼
Height	25
Id	0
LowerLimit	0
NumberOfDecimals	0
RefreshInterval	5000
ScreenId	0
TextSize	10
UpperLimit	999999
Width	80
XPos	10
YPos	10

In the table below the properties of this control are explained:

Property	Description
AlarmColor	This property changes the foreground color of the control to the selected color when the value of the shown measurement exceeds the upper or lower limit.
Angle	This property changes the angle of the control.
BackgroundColor	This property sets the background color of the control.
DataSource	With this property you select which value is shown in this control.
DefaultColor	This property sets the foreground color of the control.
FontName	With this option you can change the font type.
Height	With this option you can change the height of the control.
Id	A read-only property that shows the id that is used to store this control in the database.
LowerLimit	When the current value of the measurement shown in the control drops below the value set in this property, it will change the foreground color of the control to the alarm color.
NumberOfDecimals	This property sets the number of decimals shown in the control.
RefreshInterval	This property determines at which interval the data is retrieved from the database and thereby refreshing the control. The default value is 5 seconds but if the data shown in the control is only collected, for instance, every 5 minutes, there is now point in getting the data from the database at such a high interval. In that case an RefreshInterval of 1 or even 5 minutes makes more sense.

Property

ScreenId

TextSize

UpperLimit

Width

XPos

YPos

Description

A read-only property that shows the id of the screen this control belongs to.

With this property you can change the font size.

When the current value of the measurement shown in the control exceeds the value set in this property, it will change the foreground color of the control to the alarm color.

With this option you can change the width of the control.

With this option you can alter the x position of the control.

With this option you can alter the y position of the control.

5.4.4 Scada List

With the screen List of the Scada module you can create a selection of any device and channel, configured in Overview, and retrieve a list of there values within the selected time frame.

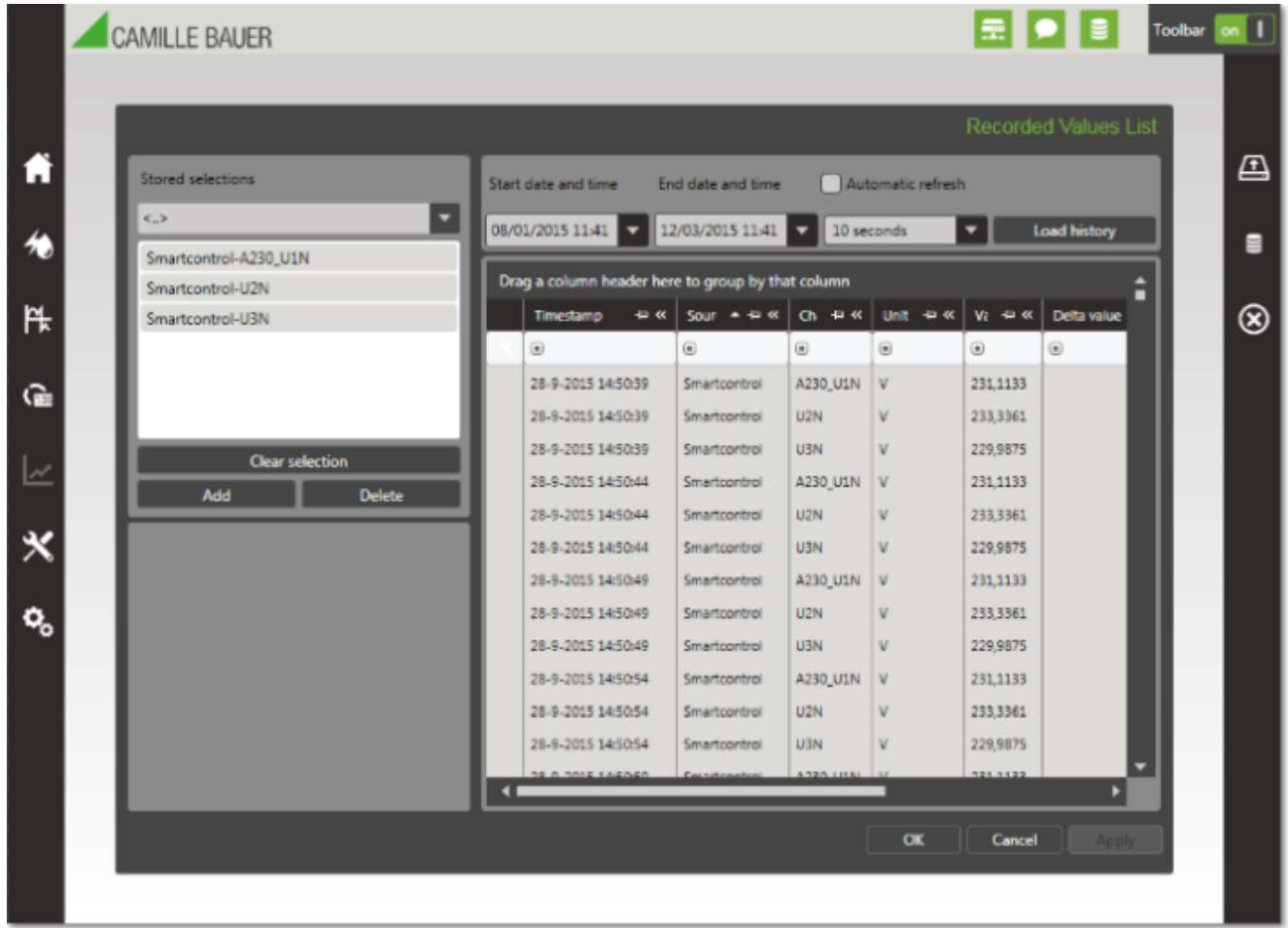

On the left side of the screen you see a dropdown list for stored selections and beneath it is a list that shows which channels are in the current selection. The screen will always start with the "<..>" selection and an empty list of selected channels.

To start using the screen you can select an have to add one or more channels to dropdown list or add one or more channels to the current selection. You do this by clicking the "Add" button below the list box and this will popup a channel selection windows like below.

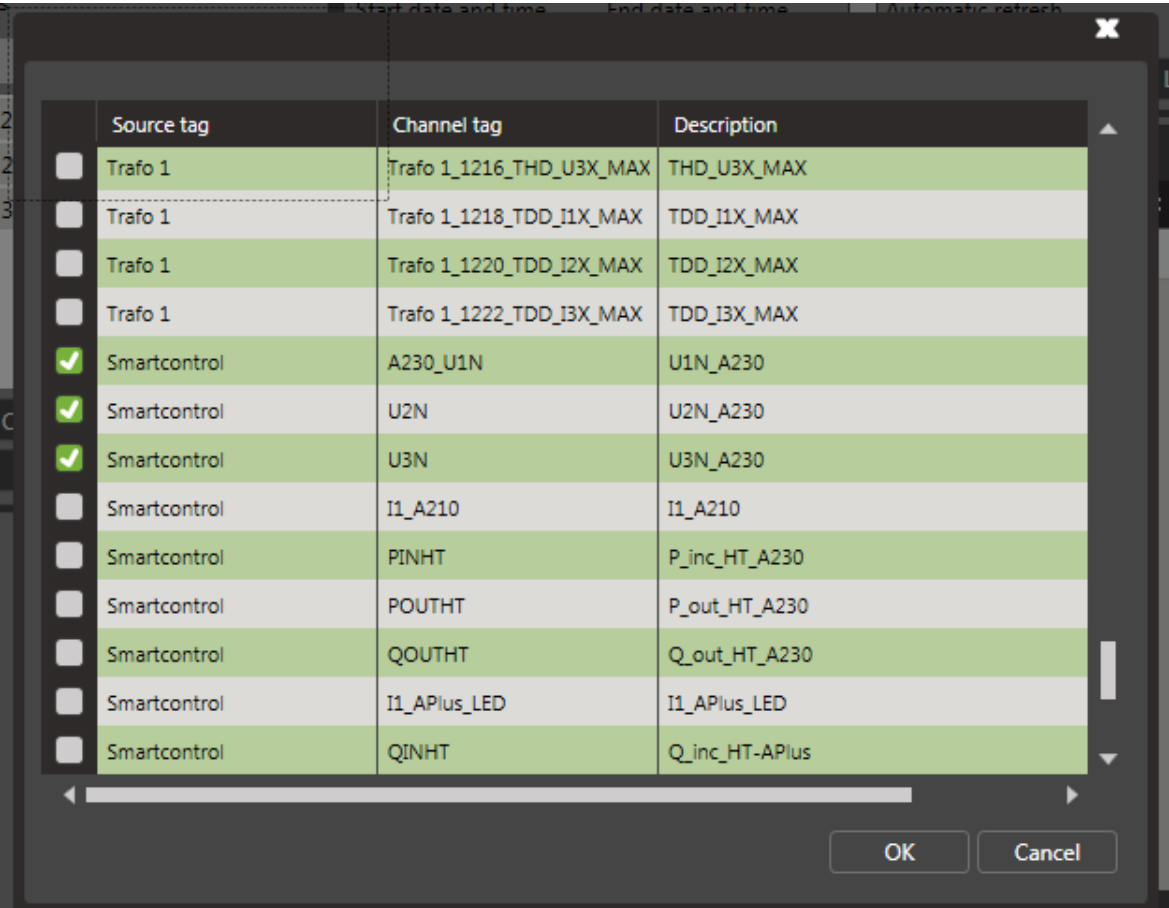

You then click on every channel you want to be part of your selection and click "OK" to leave this screen and the selected channels will be added to the list box.

You then selected the time period you want to see and when you click "Load history" the data will be retrieved from the database.

You can select an refresh interval and then check the box "Automatic refresh", to automatically reload the data at the interval you selected.

Export data to Excel

You can export the retrieved list to an Excel file (as long is the selection is not larger than 65536 rows) by opening the toolbar and selecting the option "Export".

Storing and deleting selections

You can store the selection of channels you made, if you plan to use the same selection multiple times. You can select "Save selection" from the toolbar on the right side of the screen, enter a name for the selection in the popup box and click ok. The selection will be stored in the database for later use. If you want to use a stored selection you can simply open the dropdown list below "Stored selections" and click on the selection you want and the list box will be filled with the channels of this selection.

If you want to update an existing selection you select the stored selection as explained, then make the necessary changes to it and then choose "Save selection" from the toolbar. The popup box will be filled in with the name of the currently active selection so you just click ok the update the selection in the database. If you make changes to an existing selection but do not save these changes before switching to another selection or leaving the screen, the changes will be ignored.

Below is a image of the toolbar options you have in this screen.

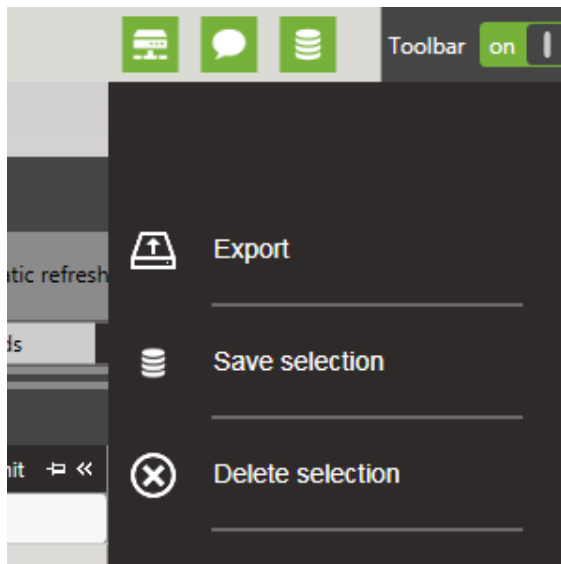

With the toolbar option "Delete selection" you delete the currently selected selection from the database.

5.4.5 Scada Graph

With the screen Graph of the Scada module you can create a selection of any device and channel, configured in Overview, and create a graph of there values within the selected time frame.

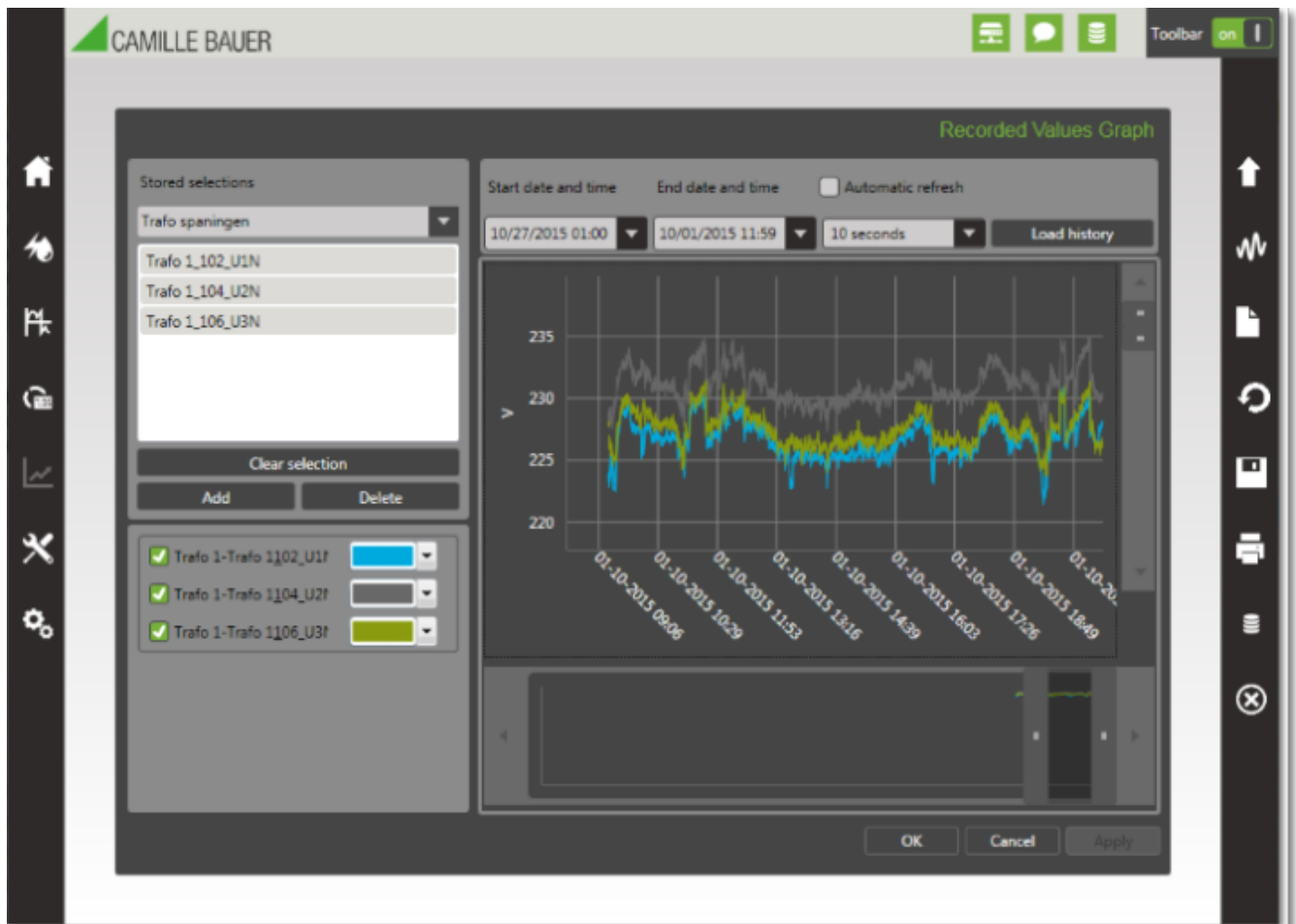

On the left side of the screen you see a dropdown list for stored selections and beneath it is a list that shows which channels are in the current selection. The screen will always start with the "<..>" selection and an empty list of selected channels.

To start using the screen you can select an have to add one or more channels to dropdown list or add one or more channels to the current selection. You do this by clicking the "Add" button below the list box and this will popup a channel selection windows like below.

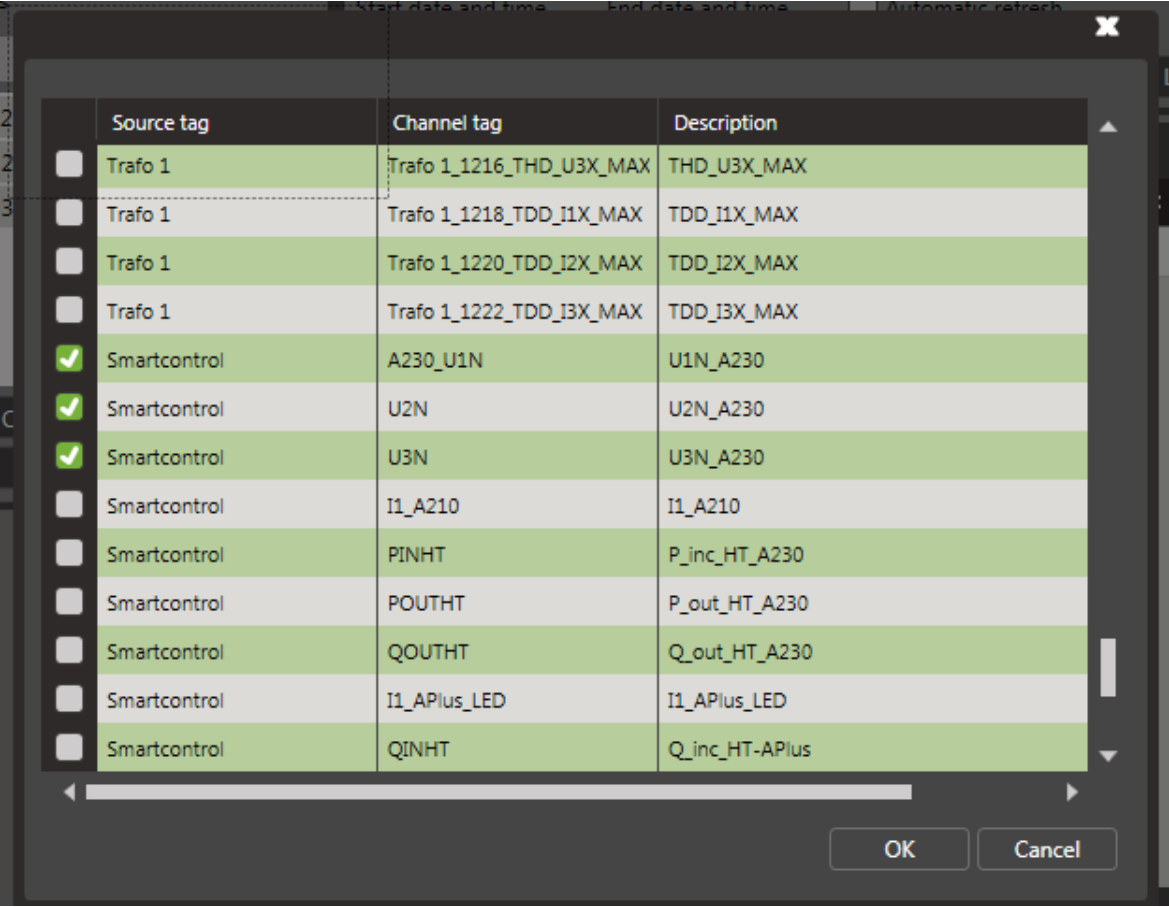

You then click on every channel you want to be part of your selection and click "OK" to leave this screen and the selected channels will be added to the list box.

You then selected the time period you want to see and when you click "Load history" the data will be retrieved from the database and the graph is created.

You can select an refresh interval and then check the box "Automatic refresh", to automatically refresh the graph at the interval you selected.

Storing and deleting selections

You can store the selection of channels you made, if you plan to use the same selection multiple times. You can select "Save selection" from the toolbar on the right side of the screen, enter a name for the selection in the popup box and click ok. The selection will be stored in the database for later use. If you want to use a stored selection you can simply open the dropdown list below "Stored selections" and click on the selection you want and the list box will be filled with the channels of this selection.

If you want to update an existing selection you select the stored selection as explained, then make the necessary changes to it and then choose "Save selection" from the toolbar. The popup box will be filled in with the name of the currently active selection so you just click ok the update the selection in the database. If you make changes to an existing selection but do not save these changes before switching to another selection or leaving the screen, the changes will be ignored.

Below is a image of the toolbar options you have in this screen.

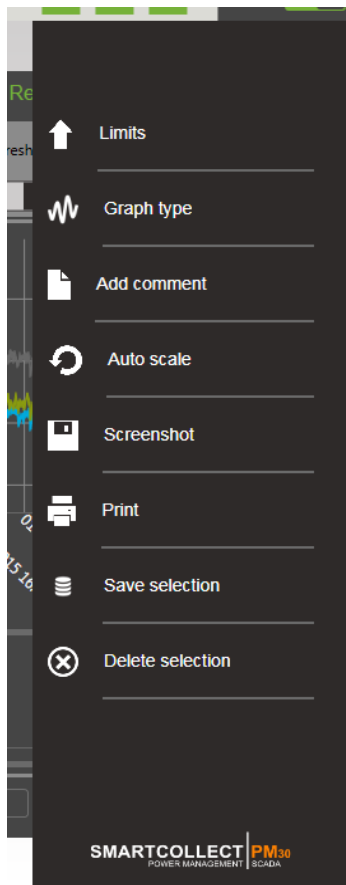

With the toolbar option "Delete selection" you delete the currently selected selection from the database. The other options of the toolbar are the same as described **here (Section 5.3.3)**.

5.5 Tools

With the Tools menu you can:

- **Start, stop and restart the SmartCollect Service (Section 5.5.1)**
- **View the logging (Section 5.5.2)**
- **View and delete scheduled jobs (Section 5.5.3)**

5.5.1 Services

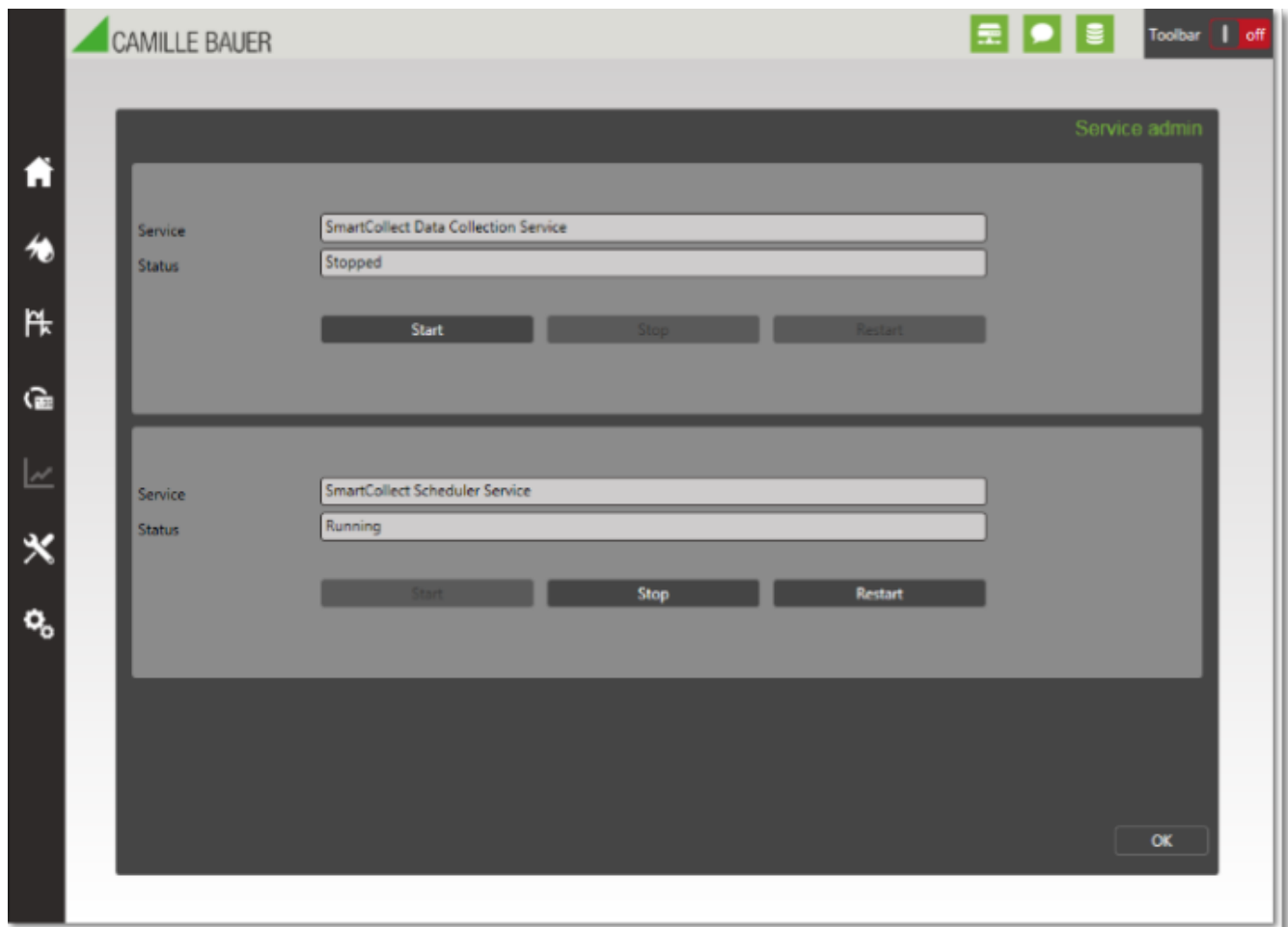

In this screen you can start, stop and restart the SmartCollect service. Before you can use this functionality, make sure the parameter "SmartCollectServer" contains the right hostname and check whether you have the necessary authorizations to control services locally or remotely. If Windows 8 or 2012 or higher operating systems are used, it is necessary to start the SmartCollect client with the "Run as administrator" option.

You can also create your own shortcut and then in the properties of this shortcut go to the tab "Shortcut", click "Advanced" and then select the option "Run as administrator".

5.5.2 Logging

This screen shows you the log information of SmartCollect.

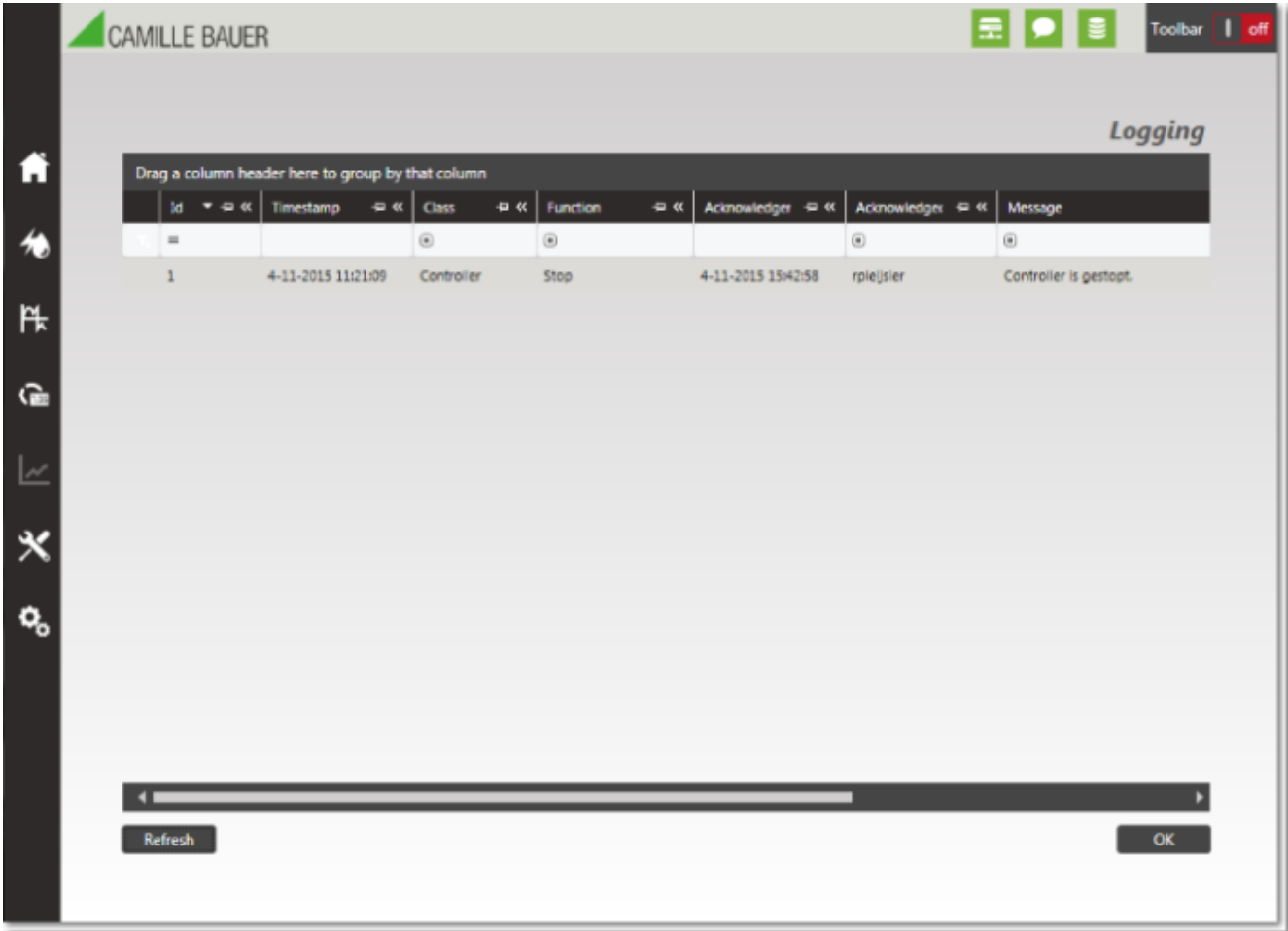

5.5.3 Job Maintenance

The "Job Maintenance" screen can be used to delete scheduled jobs that you do not want to be executed anymore and either do not have an expiration date or have one but the expiration date isn't reached yet.

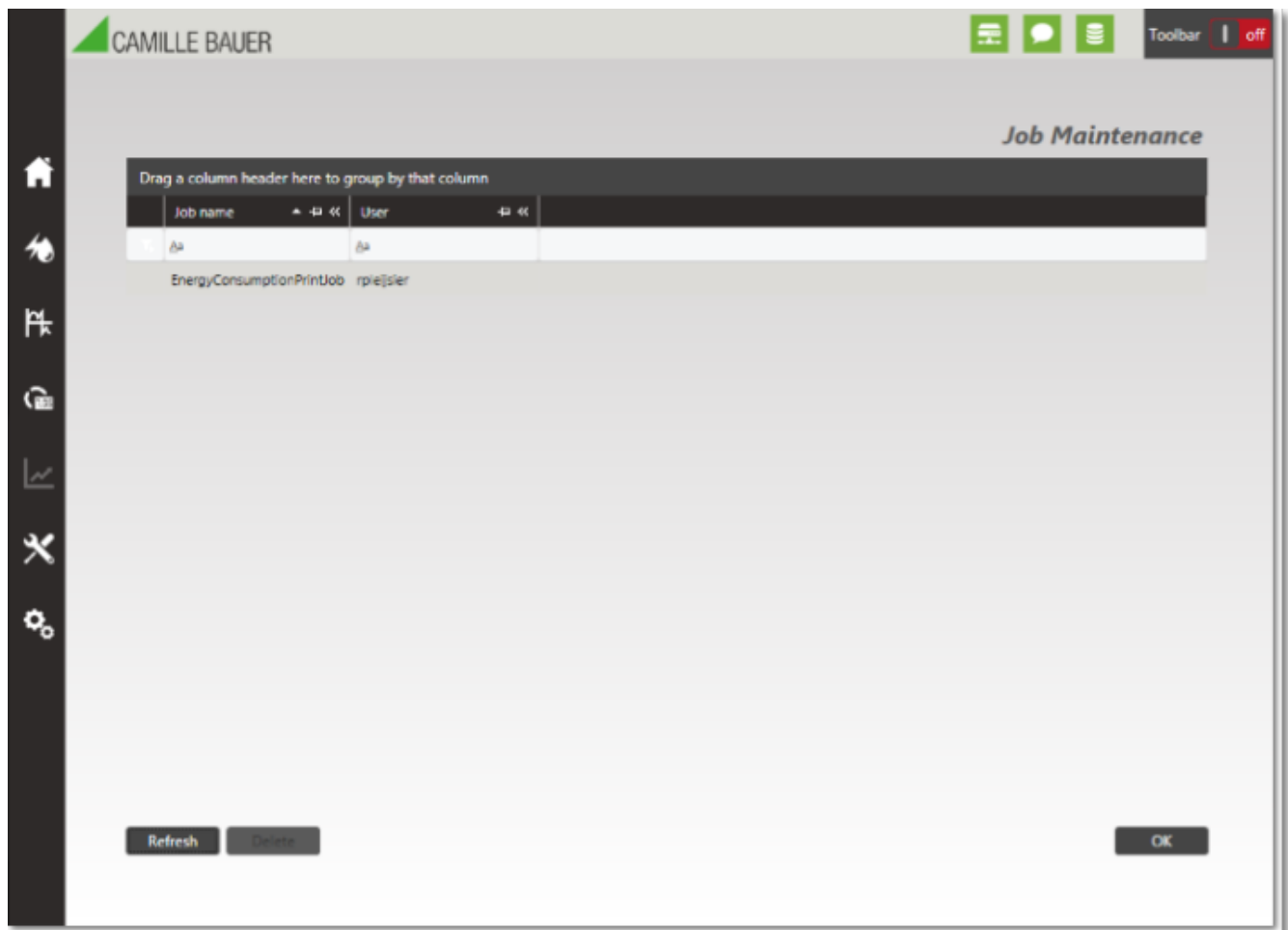

To delete a job you can simply select the line and then click "Delete".

5.6 Settings

With the Settings menu you can:

- **Maintain the configuration / parameters of the SmartCollect Service (Section 5.6.1)**
- **Maintain the serial ports (Section 5.6.2)**
- **View, deactivate and activate licenses (Section 5.6.3)**

5.6.1 Parameters

With the Configuration screen you can change all service parameters. Below you will find a table describing the meaning of each parameter.

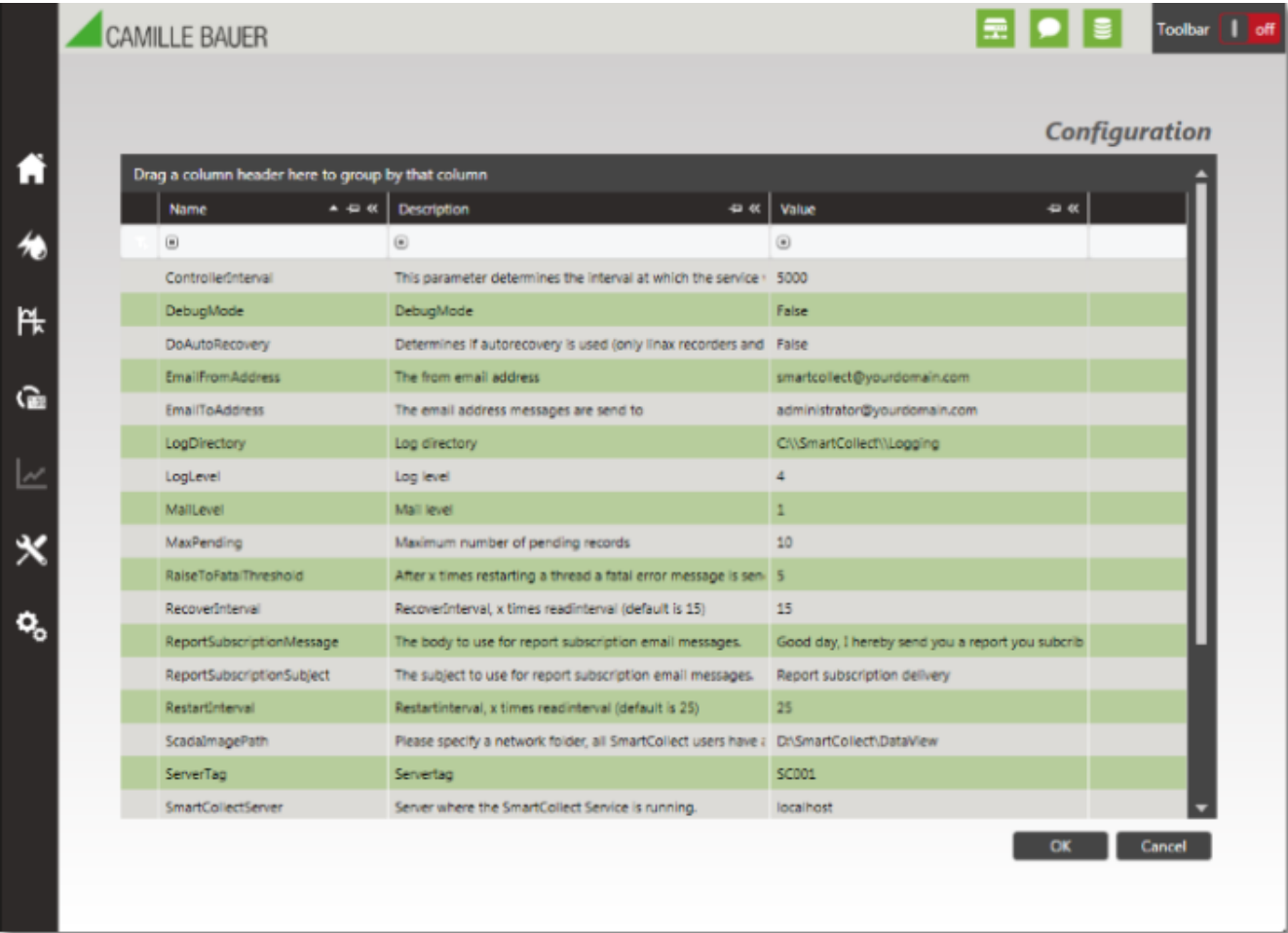

Parameter	Description	Default value
ControllerInterval	This parameter determines the interval at which the service will check if all devices are still delivering values, if there are actions to take care of or if an auto recovery needs to be started.	5000 ms
DebugMode	Not used anymore.	False
DoAutoRecovery	Determines if automatic restore of missed data should be used.	False
EmailFromAddress	The email address that is shown in the "From" field when SmartCollect has sent an email.	smartcollect@yourdomain.com
EmailToAddress	The email address to which the emails will be sent.	administrator@yourdomain.com
LogDirectory	The directory where possible log files will be saved. Under normal circumstances however log messages are only written to the database.	C:\SmartCollect\Log
LogLevel	Determines from which level logging will be saved. The following values are possible: 1 - Only fatal errors 2 - Also errors 4 - Also warnings 7 - All errors and warnings 9 - Debugging	4
MailLevel	Determines from which level a statement of error has to be emailed, 0 means no email are send.	1
MaxPending	This parameter determines how many recorded values are buffered before they are written to the database. This also is influenced by the ControllerInterval because at every ControllerInterval the recorded values are also	10

Parameter	Description	Default value
	written to the database.	
RaiseToFatalThreshold	If a source no longer delivers data, the thread in question will be restarted a number of times, in an attempt to restart communication. Every restart generates a error message of level 2 (warning). This parameter determines after how many restarts the level has to rise to level 1 (fatal error).	5
RecoverInterval	During the time in which a recorder does not deliver any data, this parameter will determine after how many times the read interval (ReadInterval) will plan a necessary recovery action at a later time, to complete the missing data in the table RecordedValues. Don't set this parameter to low to avoid too many recovery actions. A good guideline is 15 times the read interval.	15
RecoverTime	The hour at which the SmartCollect Service has to execute the necessary restore actions.	22
ReportSubscriptionMessage	The body to use for report subscription email messages.	Good day, I hereby send you a report you subscribed to.
ReportSubscriptionSubject	The subject to use for report subscription email messages.	Report subscription delivery
RestartInterval	During the time in which a source does not deliver any data, this parameter will determine after which number of times the controller interval, the thread has to be restarted. A value of 25 with a controller interval of 10000 will result in the restarting of the thread every 250 seconds.	25
ServerTag	Not used anymore.	SC001
SmartCollectServer	Server where the SmartCollect Service is running. NOTE: The default value of this parameter is "localhost". It is important to change this default value to the appropriate hostname of the one server that is running the SmartCollect Service. This is especially true when using SmartCollect in a multi-client environment because leaving this property on localhost could cause starting the service on the local PC instead of the server.	localhost
Smtpport	The SMTP port to use for email messages.	25
Smtppassword	The password to use for authentication with the SMTP service.	
Smtppuser	The username to use for authentication with the SMTP service.	
Smtpserver	The hostname or ip-address of a SMTP server that can be used for sending emails.	192.168.1.1

5.6.2 Serial Ports

With this screen you can maintain the serial ports available on the server where the SmartCollect Service is running.

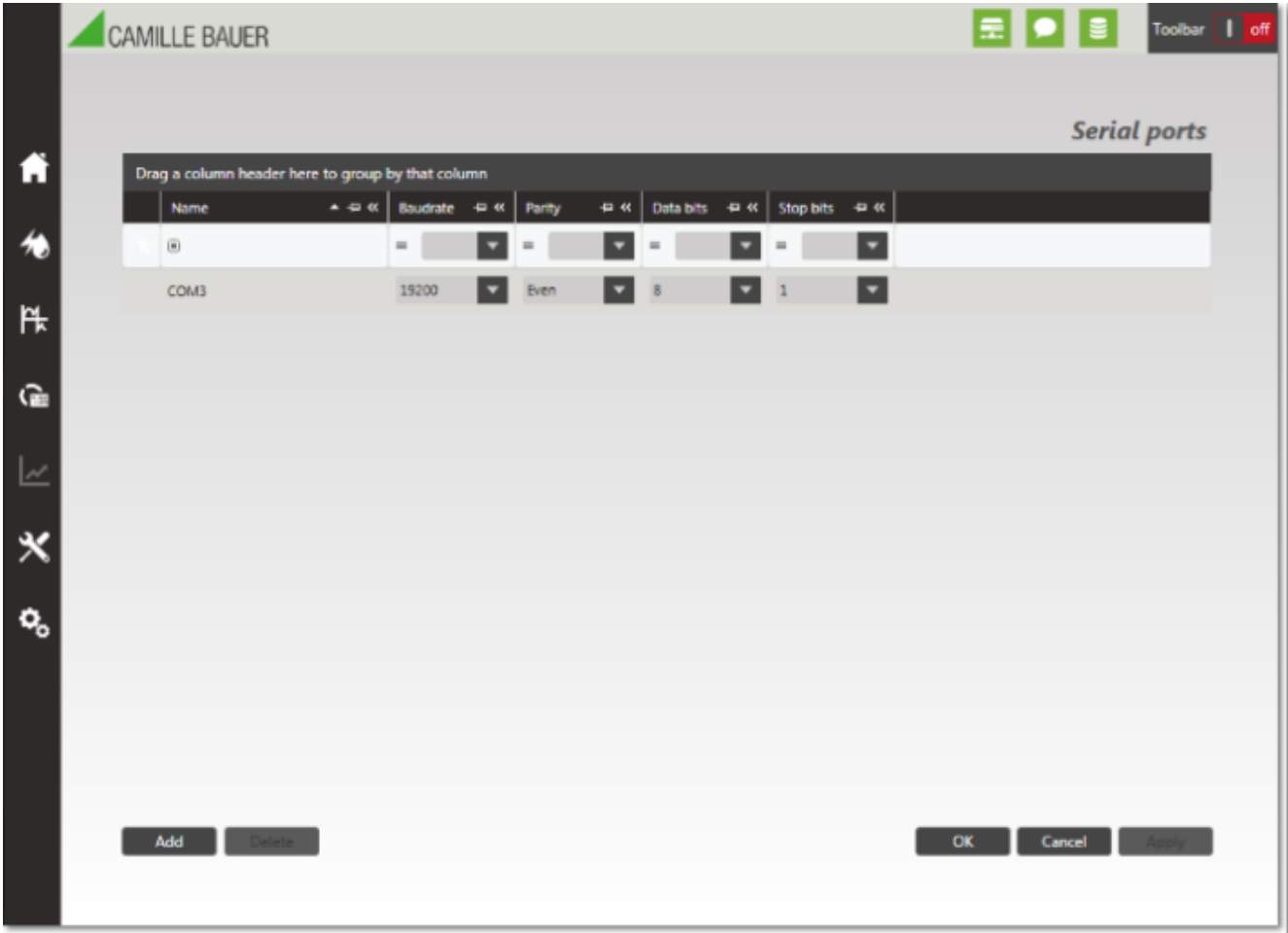

The settings of a serial port need to be the same as the communication settings configured on the devices that can be reached through that serial port. This also means that all devices behind a specific serial port need to have the same communication settings.

5.6.3 Licenses

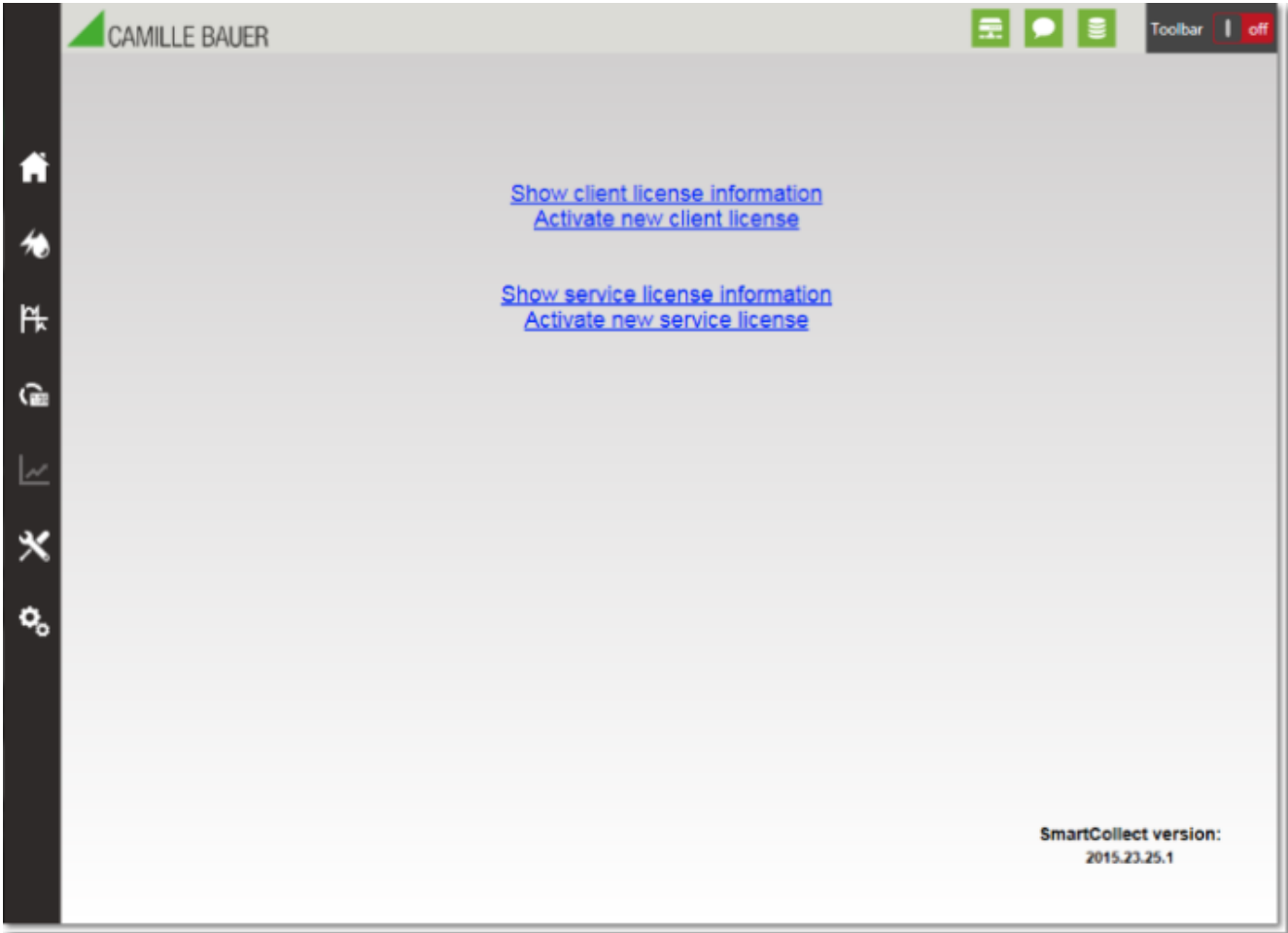

With this info screen you can activate a license, check your license or deactivate a license. For activating a license please refer to the chapter **Activating Licenses (Section 4.2)**. For checking your current license click on "Show client license information" or "Show service license information" after which the screen below is shown.

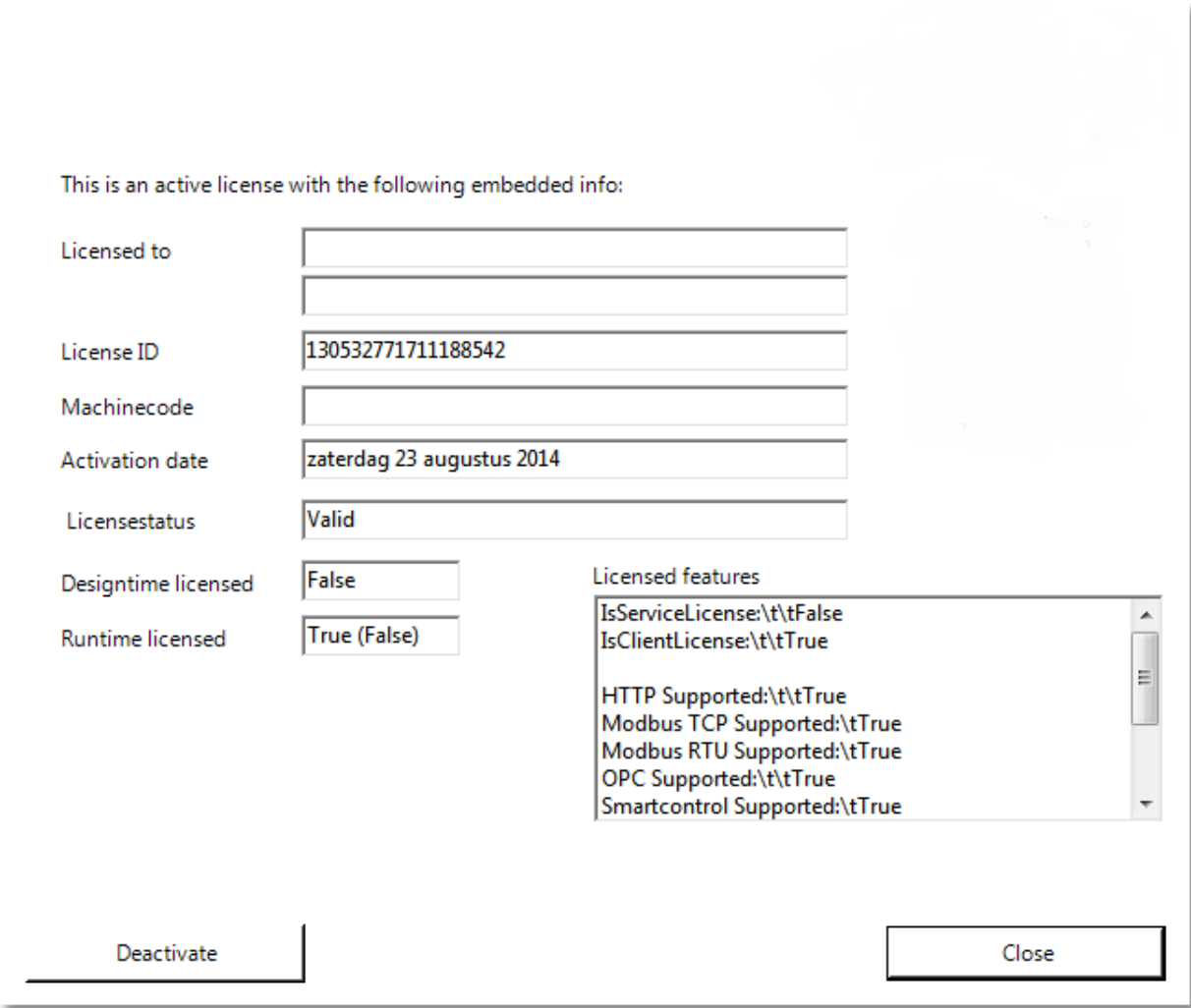

This screen shows all data of your license (in this case the client license) such as the name of the licensee (blanked in the screenshot), when the license was activated and also which features your license contains.

Besides this information you can deactivate your license in this screen. This is necessary when you want to transfer the license from this machine to another, for example when a new PC is used. When deactivating a license the activation is undone and by using the original activation code you have obtained by purchasing the software, you can activate a new PC. Warning: You cannot use the software on the deactivated machine any more.

6 SmartCollect Configurator

When SmartCollect is installed a little tool called "SmartCollect Configurator" is installed at the same time. With this application you can edit the configuration files of the installed components. There are four tabs for the different groups of settings.

- **The database settings**
- **The client settings**
- **The service settings**
- **The scheduler settings**
- **The runtime settings**

The database settings

In this tab you can configure which database is used by the application.

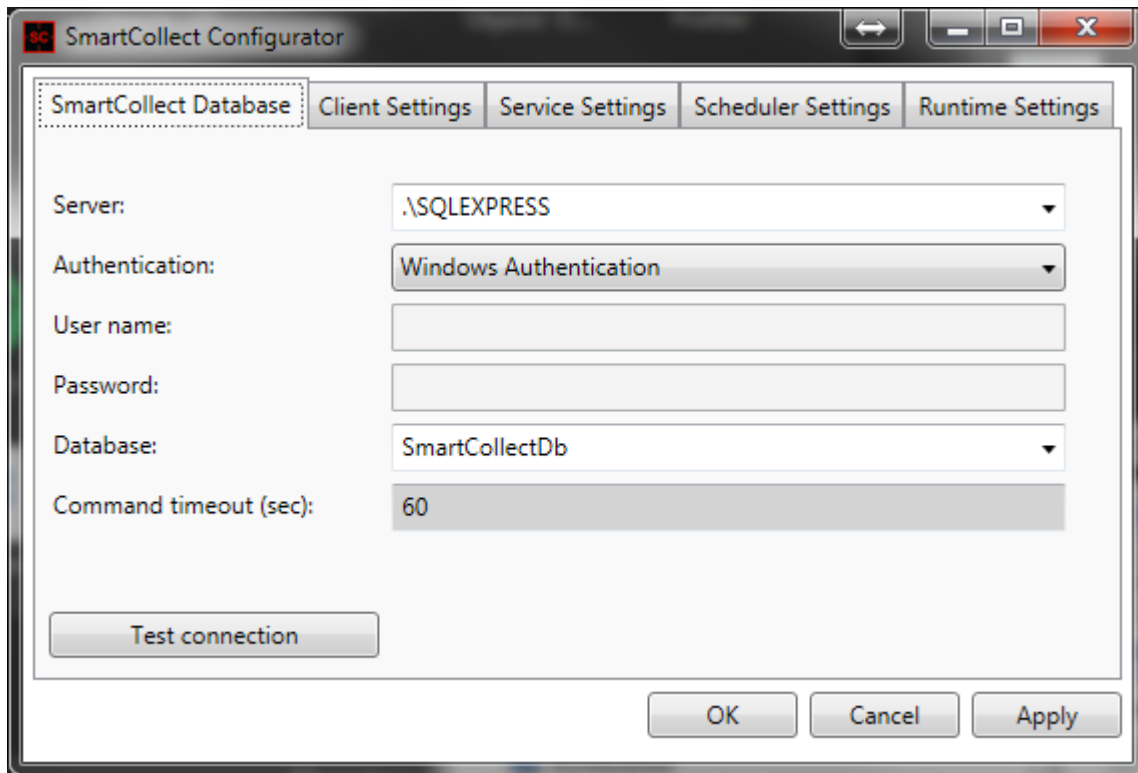

When SmartCollect is installed for the first time, as a default, it will be set to use a local Microsoft SQL Express database with windows authentication and the database name will be set to "SmartCollectDb".

When Microsoft SQL Express is not installed locally you have to enter the name of the SQL Server to use.

Which type of authentication needs to be used depends if a locally installed database is used and on the preference of your database administrator so please consult him/her for this. The account used need to have the privileges to create a database and tables.

When you would open the dropdown list you will see that a SmartCollect database does not exists yet in the database. This is because SmartCollect will create the database for you the first time you start the client and since it is a newly installed application the database is not created yet. You can fill in any name you want for the database (without special characters and spaces) and the first time you run the client application the database will be created.

If for any reason you want a second (maybe temporary) database you can just enter a new database name and the next time you start the client it will be created for you.

You also have the possibility the set the command timeout used by SmartCollect, this means the maximum time a command send to the database, for instance a command to retrieve the data for a report, may take. The default is 30 seconds and that should be enough but in some circumstances, for instance a client accessing the database via a internet connection, a longer timeout maybe needed. In the screenshot a timeout of 60 seconds is entered.

The button "Test connection" will test if the application is able to connect to the configured database. This will off course only work after the database has been created.

The client settings

On this tab you can configure the client settings.

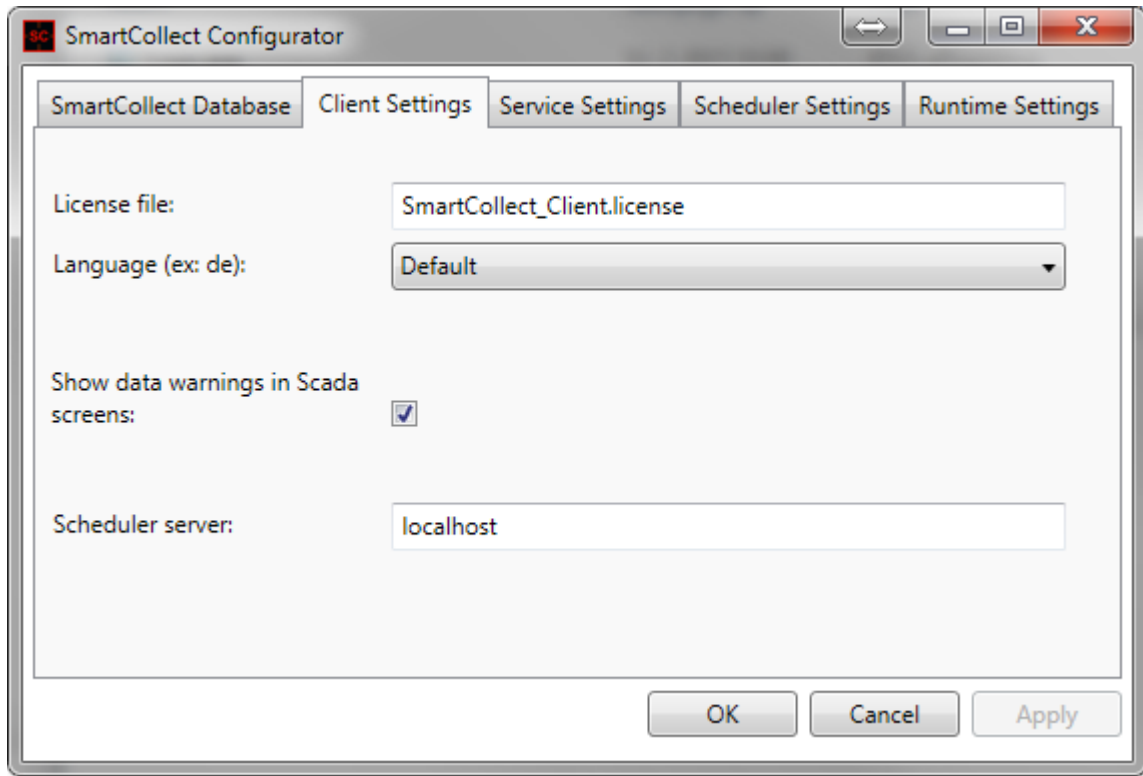

The field "License file" contains the name of the file that holds the license of the client. Optionally you can add a path in front of the filename if you do not want to store the license at its default location in the "Camille Bauer AG\SmartCollect" directory under your ProgramData directory.

With the language dropdown list you can overrule the default language. The default language means that if the language of Windows is available in SmartCollect it will use that, otherwise it will use English. However with this dropdown list you can select any of the supported languages.

 Changing the language will not influence the date and number formatting if the data saved to the database, this will always be determined by the regional settings of Windows. This means that if the SmartCollect service is running on, for instance, a Windows server which is set to United States settings, the client PC also needs to be set to the same regional settings. Changing the language to English will not be sufficient. If the client is running a Windows with Dutch settings (comma and point are opposite to US settings), the application will interpret the point in the values in the database not as a decimal separator. An example, if the database contains a value "122.55" a Windows PC with Dutch settings would see that as "12255,00" since it does not recognize the point as a decimal separator.

The checkbox "Show data warnings in Scada screens" can be used if you do not want to get a visible warning (red box around values) when Scada screens do not get data anymore. This could be helpful if you are showing some Scada screen in the lobby of your company.

The field "Scheduler server" should contain the hostname of the server or workstation where the SmartCollect Scheduler is installed. We recommend to install the Scheduler only once in your network and point the clients to this one Scheduler. Although not likely but if this one instance of the Scheduler cannot process the load it is under, you can of course install it a second time or as often as you want and divide the clients to use one of them.

The service settings

On this tab you can configure the 2 service settings.

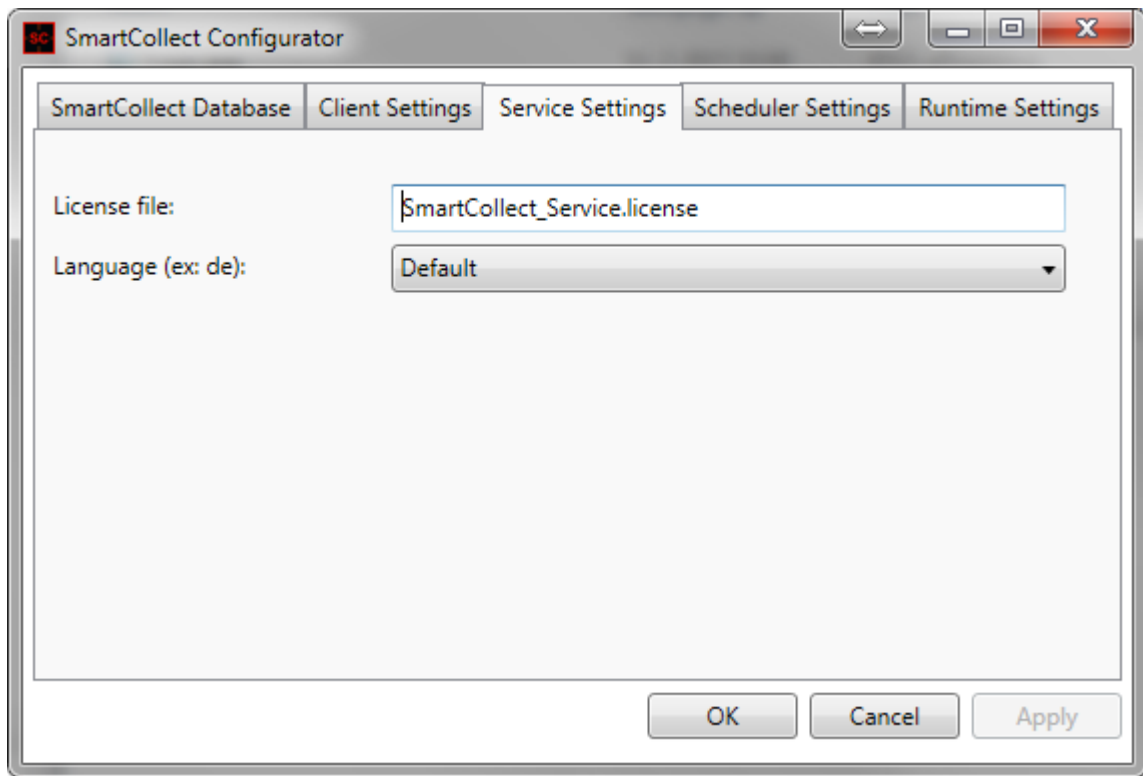

The field "License file" contains the name of the file that holds the license of the service. Optionally you can add a path in front of the filename if you do not want to store the license at its default location in the "Camille Bauer AG\SmartCollect" directory under your ProgramData directory.

With the language dropdown list you can overrule the default language. The default language means that if the language of Windows is available in SmartCollect it will use that, otherwise it will use English. However with this dropdown list you can select any of the supported languages.

 Changing the language will not influence the date and number formatting if the data saved to the database, this will always be determined by the regional settings of Windows. This means that if the SmartCollect service is running on, for instance, a Windows server which is set to United States settings, the client PC also needs to be set to the same regional settings. Changing the language to English will not be sufficient. If the client is running a Windows with Dutch settings (comma and point are opposite to US settings), the application will interpret the point in the values in the database not as a decimal separator. An example, if the database contains a value "122.55" a Windows PC with Dutch settings would see that as "12255,00" since it does not recognize the point as a decimal separator.

The scheduler settings

The scheduler settings only contain one settings to change the language (see the remarks at the client and service settings).

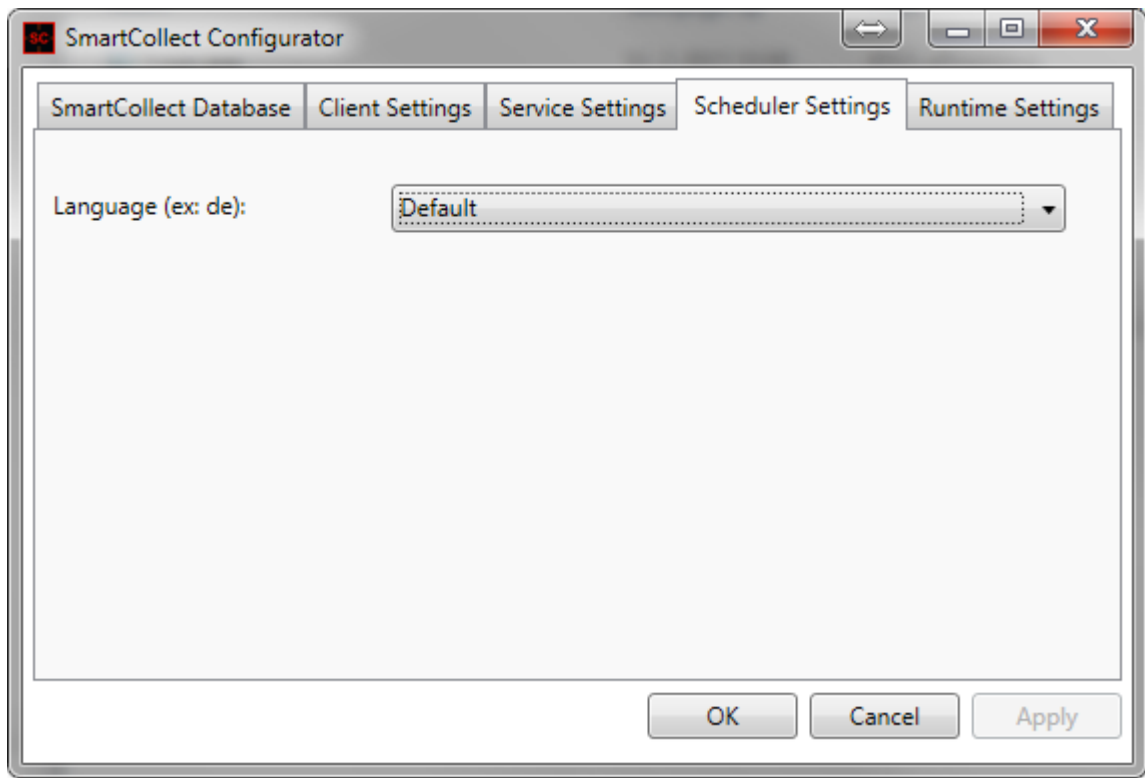

The runtime settings

The runtime settings can be used to configure the behavior of the Scada Runtime Client.

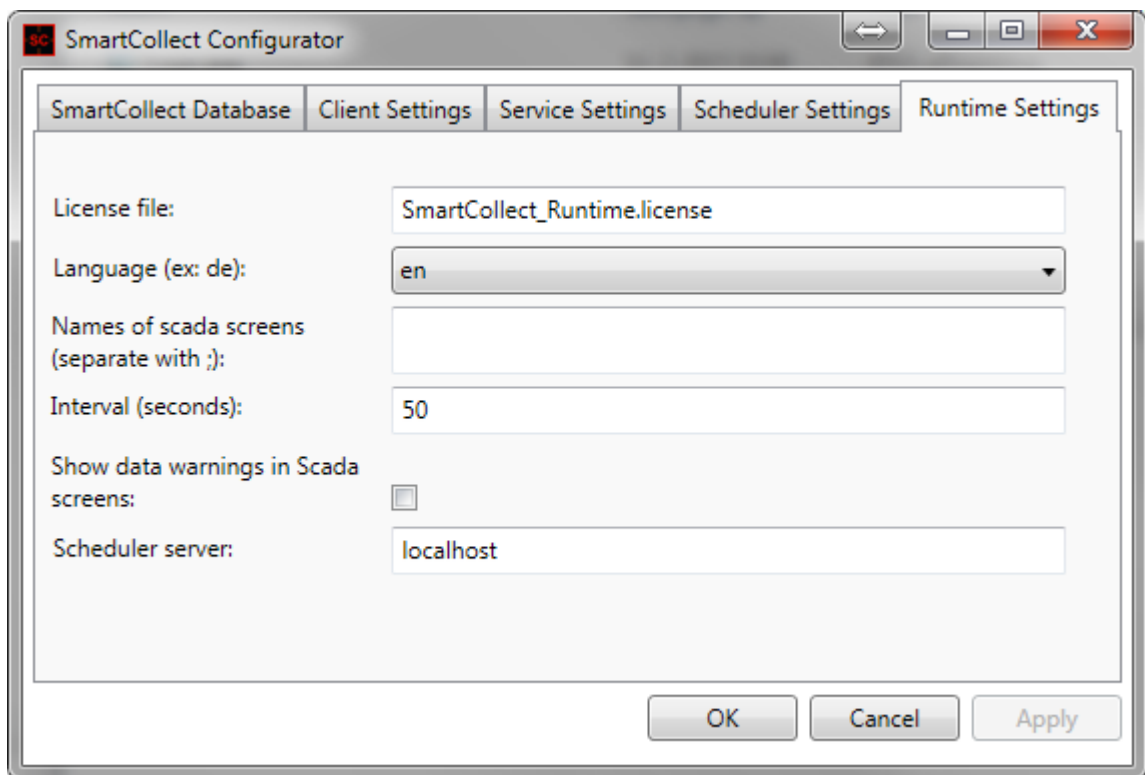

The field "License file" contains the name of the file that holds the license of the runtime client. Optionally you can add a path in front of the filename if you do not want to store the license at its default location in the "Camille Bauer AG\SmartCollect" directory under your ProgramData directory.

With the language dropdown list you can overrule the default language. The default language means that if the language of Windows is available in SmartCollect it will use that, otherwise it will use English. However with this dropdown list you can select any of the supported languages.

The field "Names of scada screens" is used to configure how the runtime client should start up. As explained **here (Section 8)**, the runtime client has 3 modes. The first mode (starting as a client application with menu bar) is achieved by leaving this field blank. The second mode (starting with a configurable scada screen) is achieved by entering the name of the Scada screen you want to see at start up. The third mode (starting in the unattended mode) is achieved by entering multiple screen names separated by a semicolon.

The field "Interval (seconds)" can be used to configure the interval between scada screen changes when running the runtime client in the third/unattended mode.

The checkbox "Show data warnings in Scada screens" can be used if you do not want to get a visible warning (red box around values) when Scada screens do not get data anymore. This could be helpful if you are showing some Scada screen in the lobby of your company.

The field "Scheduler server" should contain the hostname of the server or workstation where the SmartCollect Scheduler is installed. We recommend to install the Scheduler only once in your network and point the clients to this one Scheduler. Although not likely but if this one instance of the Scheduler cannot process the load it is under, you can of course install it a second time or as often as you want and divide the clients to use one of them.

7 Smart Collect Service

After installing you will find the SmartCollect Service in the list with all the services in the system.

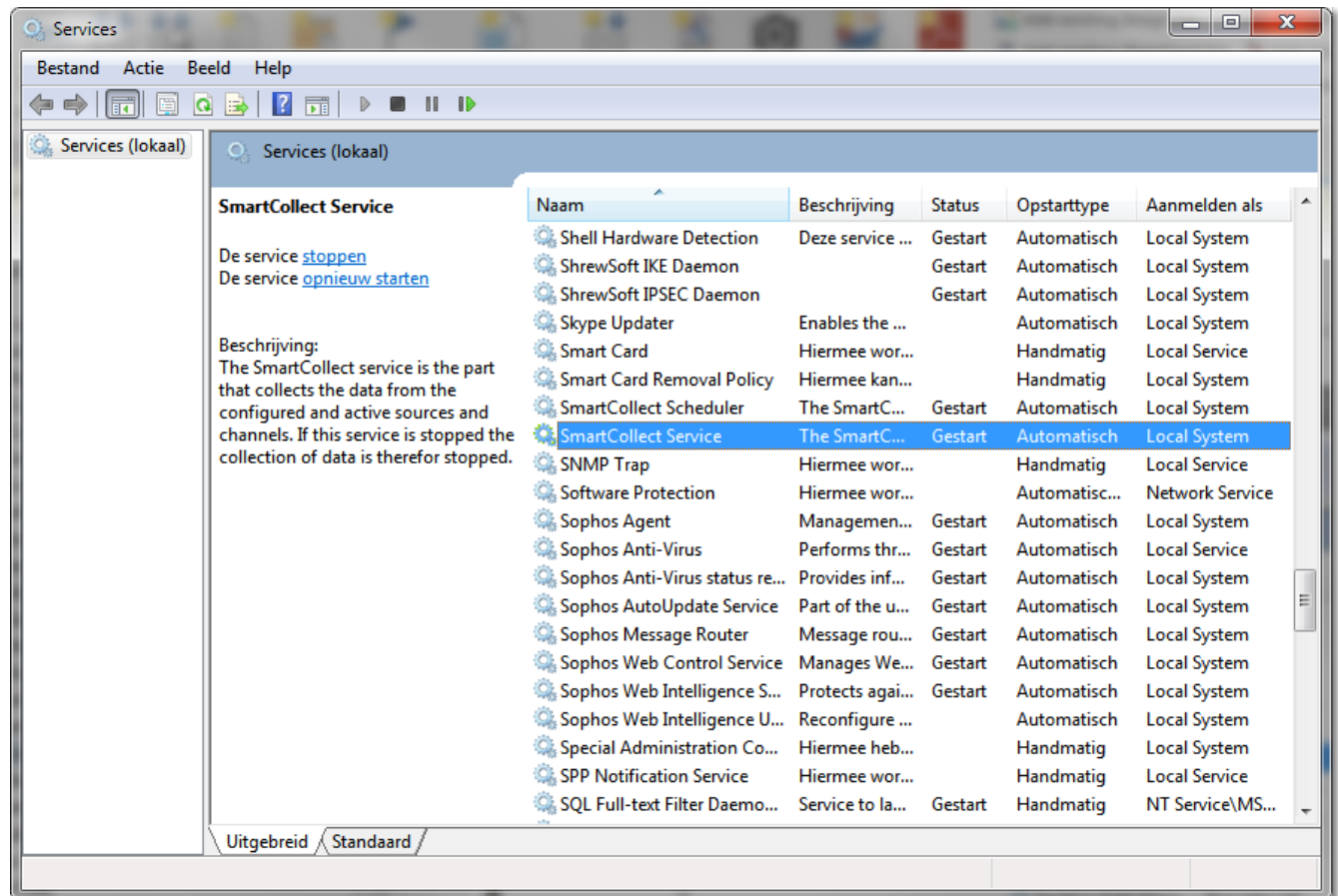

Standard the service is installed with the start up type "Manual" with account "Local System". You will probably want to change both, for changing the account see chapter "**Security (Section 7.1)**". Once the database is created it is possible to set the start up type to "Automatic" in which case the service will start automatically when the machines starts running. If you want it is possible to state under "System recovery" what needs to be done if, for whatever reason, the service should stop working all together after an error has occurred.

7.1 Service Security

By default the identity for the service is "Local System" but you probably will need to change this to a different account. The identity used to run the service is determined by the way the security of the database and the OPC Server is setup.

Database security

We recommend to use integrated security for the database connection when this is available in your database software. You then have to give the identity running the service the appropriated privileges to the SmartCollect database. For setting up database security, please consult the manual of the database software.

OPC Security

One of the things that can go wrong when implementing an OPC based communication is the part of security. For the communication with the OPC server the account is used that is running the SmartCollect service, this account must have the privileges to connect to the OPC service. The security setup of an OPC server is done with the application "Component Services" which you can find at "Administrative Tools". In this application you go to "Component Services" --> "My computer" --> "DCOM Configuration" and then you right click the OPC Server in the list and choose for "Properties". Below you see a screenshot of the properties of a GMC Smartcontrol OPC Server.

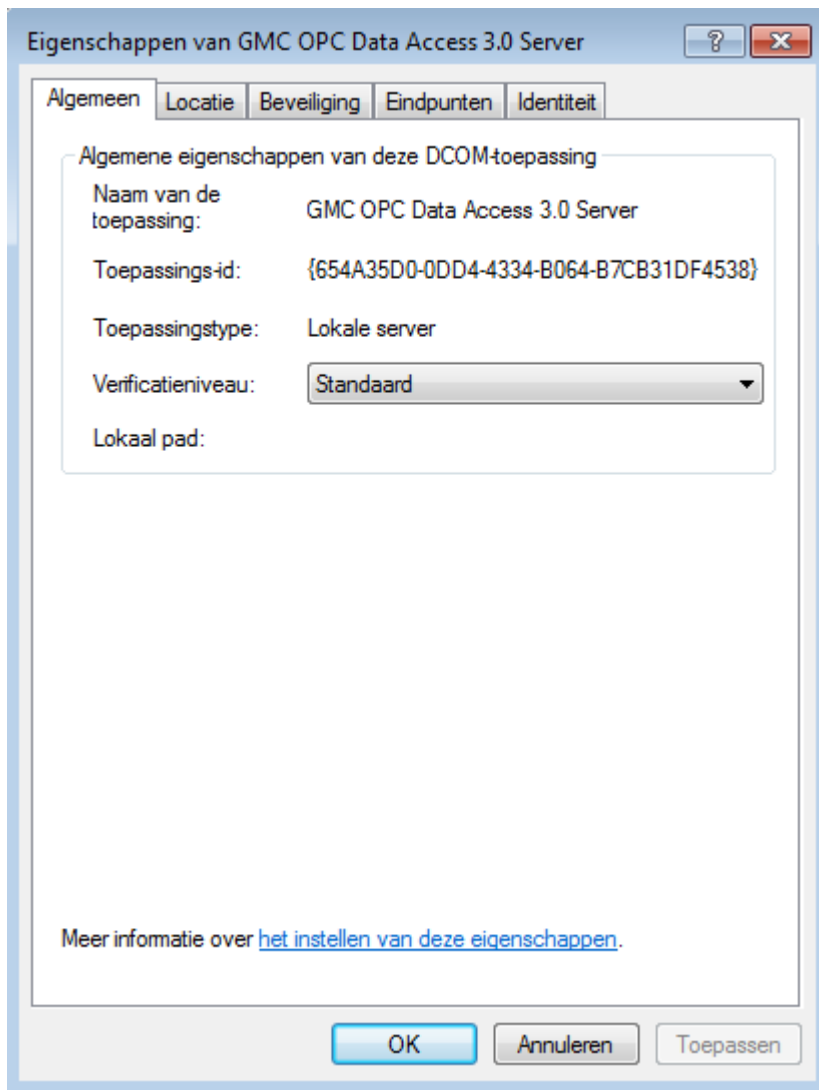

On the tab "Security" you can change the settings. By default the GMC Smartcontrol OPC Server will give "Everyone" all rights on the service and you probably want to limit this a bit. For more information you have to consult the manuals of the OPC server.

8 SmartCollect Scada Runtime Client

The SmartCollect Scada Runtime Client is a small application that can be used to view, and thus read-only, the screens developed with the Scada screen designer.

It is also possible to list and export values any combination of channels or view a graph of these values but since the functionality is exactly the same as it is in the normal (full featured) client this functionality is not explained in this topic. You can read about it here.

The Runtime Client can be used in three different ways:

1. As a client application.
2. As a client with a configurable Scada screen as startup screen.
3. As a unattended client.

Which mode you want to use can be configured with the help of the SmartCollect Configurator and is explained **here (Section 6)**.

1. As a client application

In this mode the user can access all developed Scada screens and also the list and the graph screens via the menu bar at the left of the screen. At startup the screen will look like below.

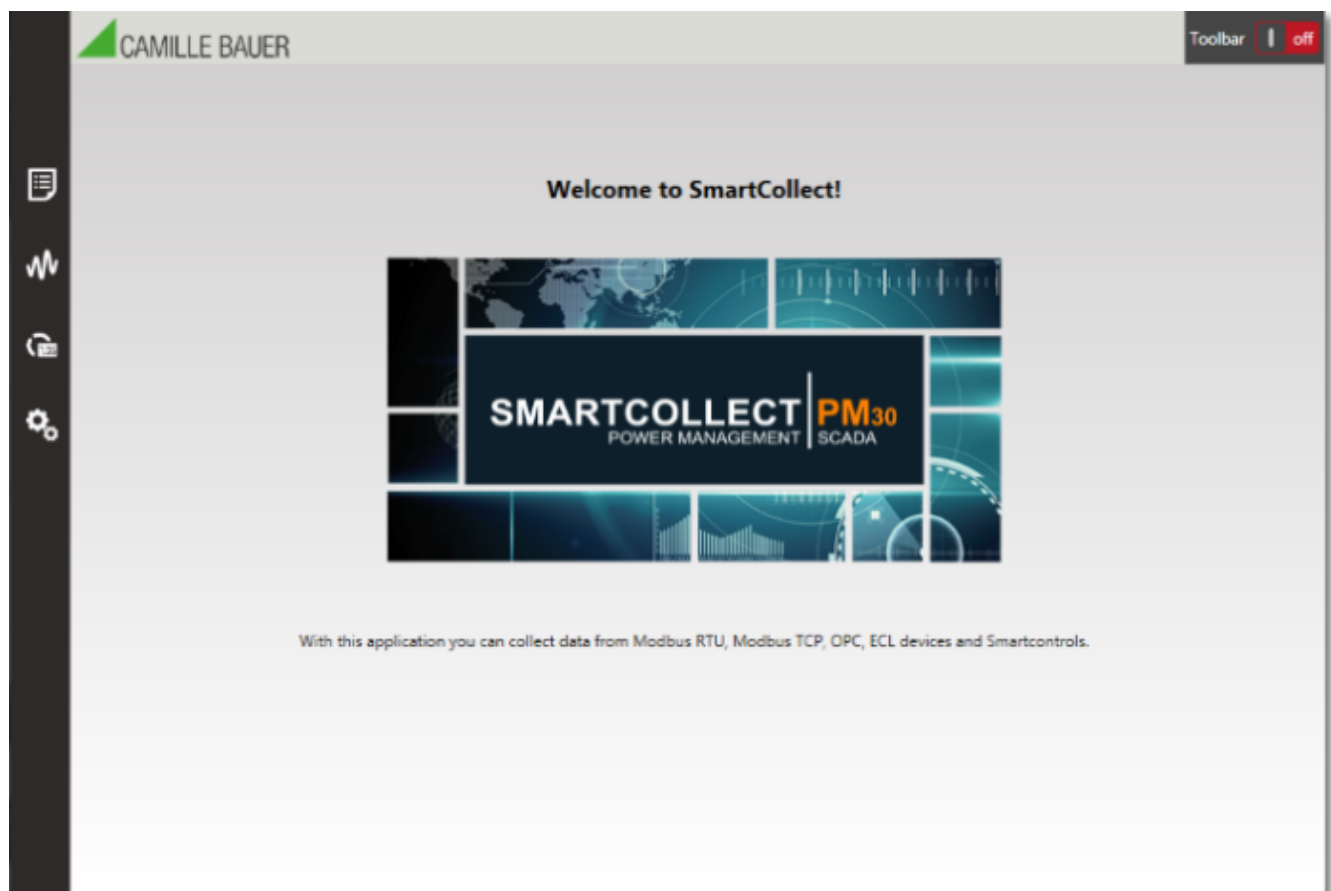

2. As a client with a configurable Scada screen as startup screen

In this mode the menu bar at the left is hidden and a configurable Scada screen is shown on startup. Because the startup screen can be any screen the user developed with the designer, the screen below is just an example of how this could look.

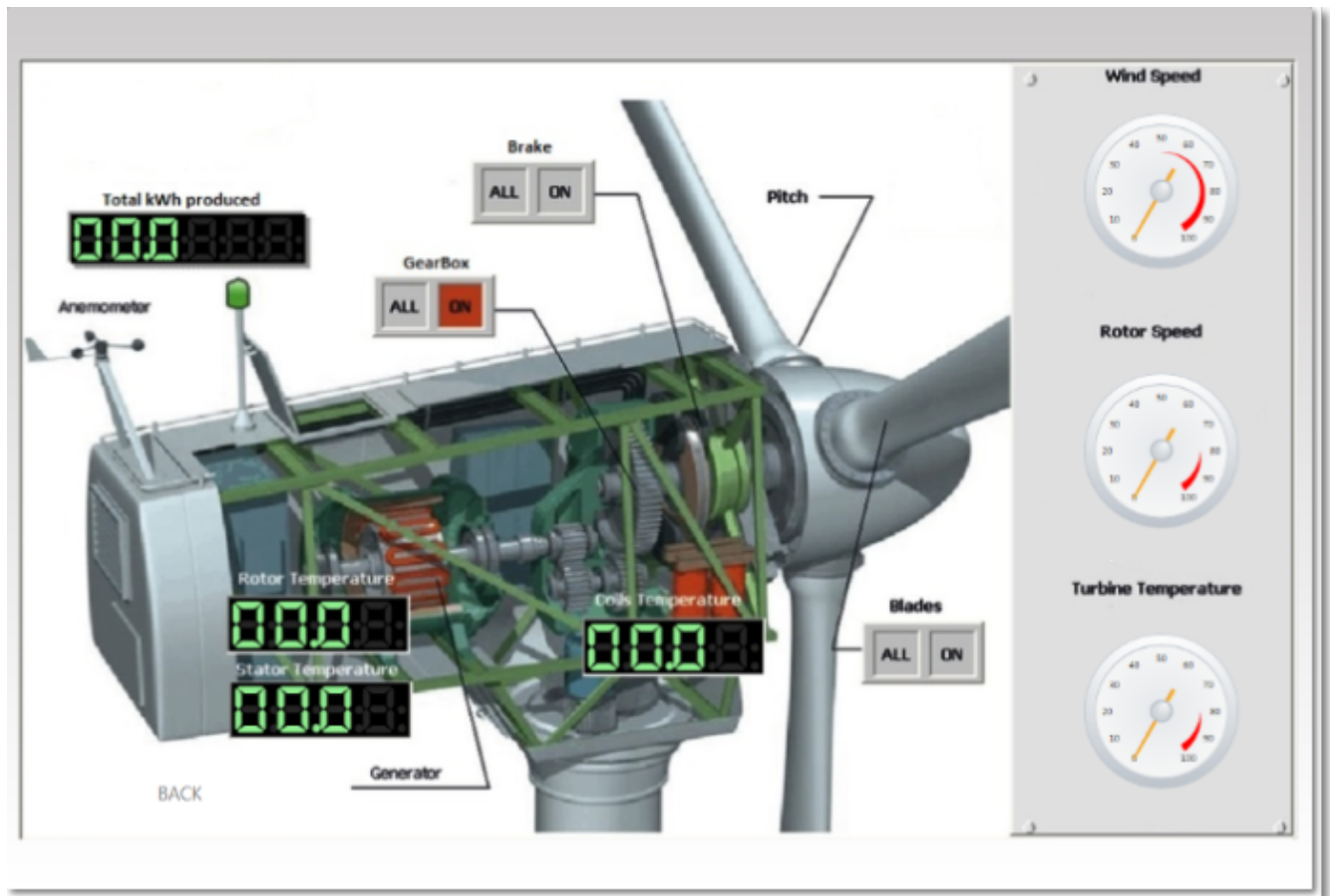

Since the Scada screen shown on startup is fully functional, it is possible to develop the screen with navigation to others Scada screens with the hotspot control. This way the user can navigate from the main screen to sub screens and back.

3. As a unattended client

In this mode a number of configurable screens will be shown, switching from one screen to the next based on a configurable interval. In this mode the client will also start in "Full screen mode", hiding the Windows taskbar and also no window borders will be shown. This mode is intended to be used for showing a number of Scada screens on a large display at, for instance, the reception desk of the company.

Because this mode does not have a toolbar and therefore does not have the red cross in the upper right corner of the screen to close the application, the way to leave and end the runtime client is by clicking the escape key.

9 SmartCollect Jobs

The executable SmartCollect.Jobs.exe is a command-line utility that can be used for a number of maintenance tasks on the database of SmartCollect. These maintenance task are:

- Moving data from RecordedValues to the history table (with or without a counter)
- Deleting data from the RecordedValuesHistory table
- Deleting data from the LogItems table



You could do these task directly in SQL Management Studio but the execution through SmartCollect Jobs has one big advantage and that is that the process executing the task is started with a low priority. Because of this the normal processes will get priority over the tasks of SmartCollect Jobs. The duration of the tasks can be a bit longer because of this but they will not interfere with the data collection.

The following arguments are supported:

Short argument	Long argument	Description
-a	--action	The action to be taken, this can be: MoveRecordedValuesToHistory MoveRecordedValuesToHistoryWithCounter DeleteRecordedValuesHistory DeleteOldLogging
-o	--olderThanDays	This determines how old a recorded value or a logitem can be before it is moved to history or before a logitem is deleted.

The execution of a certain task can be done from the command-line entering one of the following commands (Attention: on a 32 bits machine the path can deviate from the path shown here) :

C:\Program Files (x86)\Camille Bauer AG\SmartCollect 2013\SmartCollect.Jobs.exe -a CleanupRecordedValues

C:\Program Files (x86)\Camille Bauer AG\SmartCollect 2013\SmartCollect.Jobs.exe -a CleanupRecordedValuesWithCounter

C:\Program Files (x86)\Camille Bauer AG\SmartCollect 2013\SmartCollect.Jobs.exe -a MoveRecordedValuesOnly

C:\Program Files (x86)\Camille Bauer AG\SmartCollect 2013\SmartCollect.Jobs.exe -a DeleteOldLogging -o 60

Usually these tasks are planned with the Windows Task Scheduler.

10 Troubleshooting

This chapter describes error messages from SmartCollect with an explanation of the message and what you can do about it. This section will be constantly extended with everything users report and where a solution is known. We ask our customers to use the "Send comments" option to send new additions to this chapter. We will add the reported problems and solutions here so that this information is available for everyone.

Problems:

- **Message "Underlying provider failed..." (Section 10.1)**
- **Starting the service gives an error message (Section 10.2)**
- **Modbus.SlaveException (Section 10.3)**
- **Using SmartCollect trace functionality (Section 10.4)**
- **Services screen in the Client gives "Access Denied" message (Section 10.5)**

10.1 Underlying Provider Failed

When you see the message "The underlying provider failed on open", the application is not able to connect to the database defined in the configuration file. This can have several causes:

- The database defined in the configuration file is incorrect
- The database is not created because the option `RecreateDatabaseOnChange` is set to "False"
- The database server is down

10.2 Service Start Fails

When you get an error message stating that the service is started and ended the event log will give you the real error message.

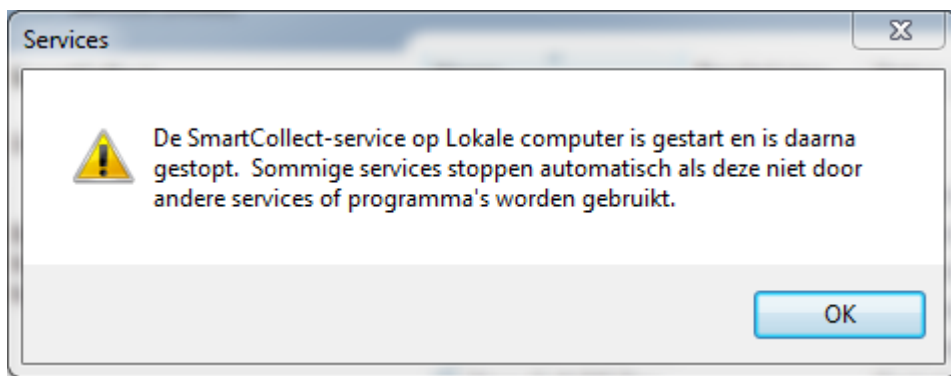

The event in the event log:

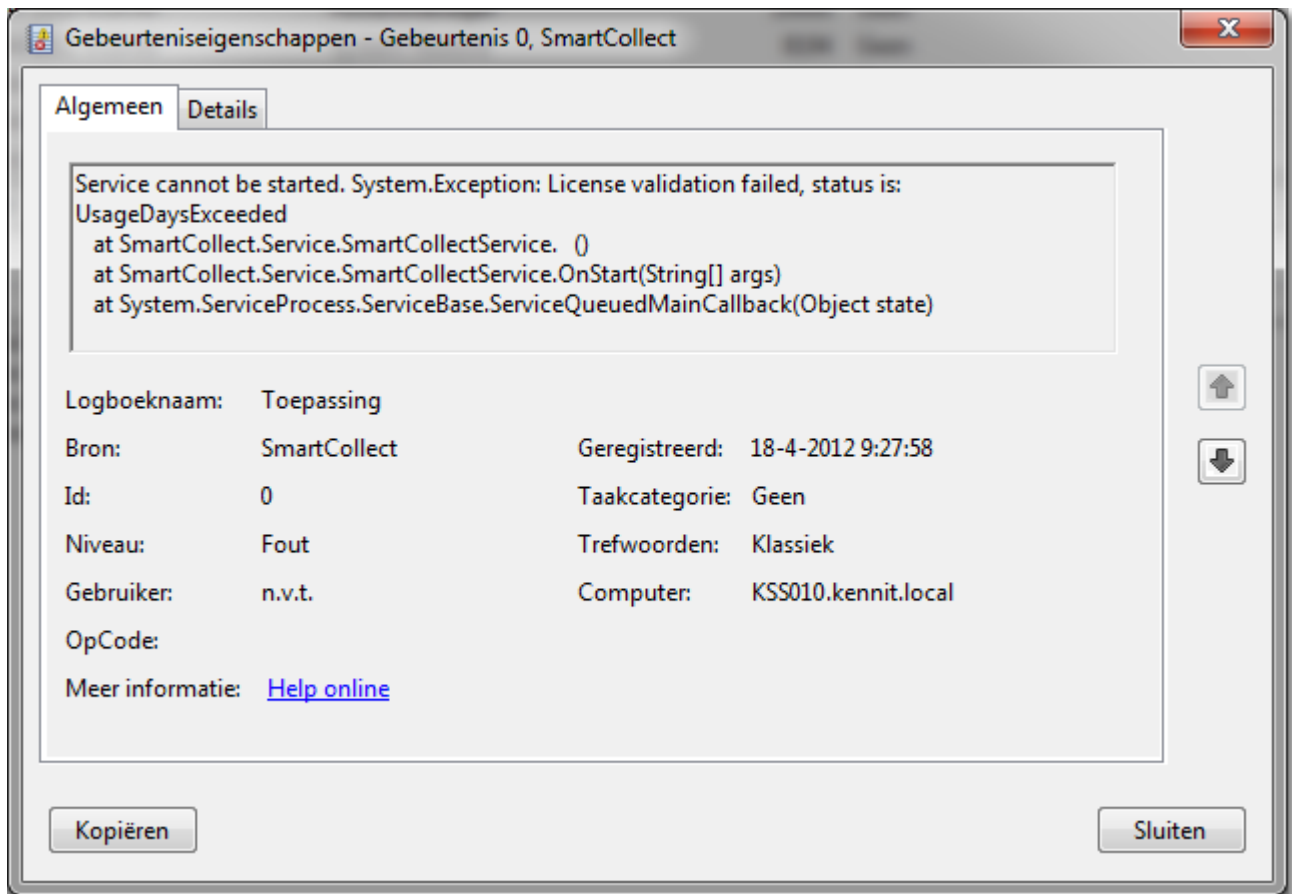

In this case there is a problem with the license. The message is saying that the maximum usage days are exceeded, this means that the service is using an evaluation license that is exceeded. If you have a license it could be one of the following two problems:

- The license file defined in the configuration file is incorrect.
- The account used to start the service doesn't have the privileges to read the configuration file.

10.3 Modbus Slave Exception

The error message below can be caused by a faulty coil or holding register address in the channel.

Could not read data: Exception of type 'Modbus.SlaveException' was thrown.
Function Code: 131 Exception Code: 7 - Unknown slave exception code.

10.4 Using SmartCollect Trace

To investigate problems with SmartCollect that cannot be solved using normal logging output, it is possible to turn on trace messages generated by SmartCollect components. To turn on the generation of these message, you will need to add a system environment variable with the name "SMARTCOLLECT_TRACE". To do this go to the "Advanced system settings" and add this variable and set the value to "true".

After it is switched on, you have to use a separate tool to view these messages. There are several tools on the internet for this and one of these is the Microsoft's Sysinternal DebugView tool. You can download a copy of this tool at:

<http://technet.microsoft.com/en-us/sysinternals/bb896647.aspx>

After starting up debugview you only need to restart the SmartCollect Service and you will see the message appear in the debugview tool. Maybe the information is a bit to much for you, you can still export the collected messages and send them to support. This can be very helpful in diagnose the cause of the problem you are facing.

10.5 Services Access Denied

When you try to start, stop or restart one of the services of SmartCollect and you receive an "Access denied" error message, it means your account does not have the appropriate privileges to control Windows services and Windows security is therefore blocking access to them.

The two most important items to check when you receive this error message is:

1. Do you have admin rights on the server that is running the SmartCollect service you want to start, stop or restart.
2. Is User Account Control (UAC) disabled on the PC your are running the SmartCollect client on.

Both will prevent access to the services.

11 Index

Activating Licenses, 7-9
Add Device Wizard, 22-28
Adding a power quality device, 34-36
Administer Scada Screens, 46-48
Booklet Cover Page, 0
Channels, 20-22
Configuration, 7
Copyright Notice, 96
Cyclic Data, 36-37
Cyclic Data Toolbar, 37-41
Date and time control, 49-51
Design Controls, 49
Designing Scada Screens, 48-49
Devices, 15-20
Electrical switch control, 63-64
Energy Management, 28-30
Graph control, 51-53
Groups, 14-15
Hotspot control, 53-54
How SmartCollect works, 4
Image control, 55
Installation, 5-6
Introducing SmartCollect, 3
Job Maintenance, 74-75
Level indicator control, 55-57
Licenses, 78-80
Logging, 73-74
Main Screen, 10-12
Modbus Slave Exception, 92
Numeric display control, 57-59
Overview, 12-14
Parameters, 75-77
Power Quality, 33-34
Power Quality 10 ms recordings, 42-44
Power Quality Data Im/Export, 45-46
Power Quality Events, 41-42
Power Quality Reports, 41
Power Quality Scope, 44-45
Print Consumption Reports, 30-32
Push button control, 59-60
Radial gauge control, 60-61
Scada, 46
Scada Graph, 70-72
Scada List, 68-70
Schedule Energy Consumption, 32-33
Serial Ports, 77-78
Service Security, 86-87
Service Start Fails, 91-92
Services, 72-73
Services Access Denied, 93
Settings, 75
Smart Collect Service, 86

SmartCollect Configurator, 81-85
SmartCollect Jobs, 90
SmartCollect Scada Runtime Client, 88-89
State led control, 62-63
Text element control, 64-65
Toggle switch control, 65-66
Tools, 72
Troubleshooting, 91
Underlying Provider Failed, 91
User Account Control, 7
Using SmartCollect Trace, 92-93
Value display control, 66-68

12 Copyright Notice

© 2015, Kennit Software Solutions B.V.

ALL RIGHTS RESERVED. This manual contains material protected under International and Federal Copyright Laws and Treaties. Any unauthorized reprint or use of this material is prohibited. No part of this book may be reproduced or transmitted in any form or by any means, electronic or mechanical, including photocopying, recording, or by any information storage and retrieval system without express written permission from Kennit.