

**Betriebsanleitung
Multifunktionales
Leistungsmessgerät**



**Mode d'emploi
Indicateur puissance
multifunction**

**Operating Instructions
Multifunctional
Power Monitor**

SINEAX A 210/A 220

Camille Bauer AG
Aargauerstrasse 7
CH-5610 Wohlen/Switzerland
Telefon +41 56 618 21 11
Telefax +41 56 618 35 35
info@camillebauer.com
www.camillebauer.com

A 210/A 220 Bd-f-e 151 118-07 01.11



Geräte dürfen nur fachgerecht entsorgt werden!

Sicherheitshinweise

Die Installation und Inbetriebnahme darf nur durch geschultes Personal erfolgen.

Überprüfen Sie vor der Inbetriebnahme, dass:

- die maximalen Werte aller Anschlüsse nicht überschritten werden, siehe Kapitel «Technische Daten»
- die Anschlussleitungen nicht beschädigt und bei der Verdrahtung spannungsfrei sind
- Energierichtung und Phasenfolge stimmen.

Das Gerät muss ausser Betrieb gesetzt werden, wenn ein gefahrloser Betrieb (z.B. sichtbare Beschädigungen) nicht mehr möglich ist. Dabei sind alle Anschlüsse abzuschalten. Das Gerät ist an unser Werk bzw. an eine durch uns autorisierte Service-stelle zu schicken.

Ein Öffnen des Gehäuses bzw. ein Eingriff in das Gerät ist verboten. Das Gerät hat keinen eigenen Netzschalter. Achten Sie darauf, dass beim Einbau ein gekennzeichnete Schalter in der Installation vorhanden ist und dieser vom Benutzer leicht erreicht werden kann.

Bei einem Eingriff in das Gerät erlischt der Garantieanspruch.



Les appareils ne peuvent être éliminés que de façon appropriée!

Consignes de sécurité

L'installation et la mise en service doivent impérativement être faites par du personnel spécialement formé.

Avant la mise en service vérifier les points suivants:

- ne pas dépasser les valeurs maximales de tous les raccordements, voir chapitre «Caractéristiques techniques».
- s'assurer que les lignes raccordées ne soient ni abimées ni sous tension.
- vérifier que le sens d'énergie et la suite des phases soient corrects.

L'appareil doit être mis hors service si un fonctionnement sans danger n'est plus possible (p. ex. suite à un dommage visible). Tous les raccordements doivent être déconnectés. L'appareil doit être retourné en usine resp. à un atelier autorisé pour faire des travaux de service.

Toute intervention et l'ouverture de l'appareil sont interdites. L'appareil ne possède pas d'interrupteur principal propre. Faire attention qu'un interrupteur bien repéré et facilement atteignable par l'utilisateur soit installé.

Toute intervention dans l'appareil entraîne l'extinction de la clause de garantie.



The instruments must only be disposed of in the correct way!

Safety notes

The installation and commissioning should only be carried out by trained personnel.

Check the following points before commissioning:

- that the maximum values for all the connections are not exceeded, see the "Technical data" section,
- that the connection wires are not damaged, and that they are not live during wiring,
- that the power flow direction, and the phase rotation are correct.

The instrument must be taken out of service if safe operation is no longer possible (e.g. visible damage). In this case, all the connections must be switched off. The instrument must be returned to the factory or to an authorized service dealer.

It is forbidden to open the housing and to make modifications to the instrument. The instrument is not equipped with an integrated circuit breaker. During installation check that a labeled switch is installed and that it can easily be reached by the operators.

Unauthorized repair or alteration of the unit invalidates the warranty.

Inhaltsverzeichnis

	Seite
Kurzbeschreibung	2
Technische Daten	2
Wartungshinweis	2
Inbetriebnahme	3
Elektrische Anschlüsse	3
Anschlussarten	3
Anzeige und Bedienung	5
Verfügbare Messdaten	5
Anzeigeebenen	6
Bedienung	6
Programmierung	7
Werkseinstellungen	7
Übersicht der Parameter	7
Kurzanleitung zum Ändern der Parameter	29
Diagramm Programmierung	30
Masszeichnungen	32

Sommaire

	Page
Description brève	11
Caractéristiques techniques	11
Conseil pour la maintenance	11
Mise en service	12
Raccordements électriques	12
Possibilités de raccordement	12
Affichage et utilisation	14
Données de mesure disponibles	14
Niveaux d'affichage	15
Utilisation	15
Programmation	16
Réglage en usine	16
Aperçu des paramètres	16
Instruction abrégée pour modifier les paramètres	29
Diagramme des programmations	30
Croquis d'encombrements	32

Contents

	Page
Brief description	20
Technical data	20
Note of maintenance	20
Commissioning	21
Electrical connections	21
Connection modes	21
Display and operating	23
Available measurement data	23
Display levels	24
Operating	24
Programming	25
Factory default	25
Parameters overview	25
Brief operating instruction for parameter modification	29
Programming charts	30
Dimensional drawings	32

Kurzbeschreibung

Das Gerät A 210 ist ein Einbaugerät im Format 96 x 96 mm, das Gerät A 220 ist ebenfalls ein Einbaugerät im Format 144 x 144 mm. Beide dienen der Analyse von Wechselstromnetzen. Erfasst werden Spannungen, Ströme, Frequenz und Phasenverschiebungen in 1-phasen- bzw. 3-phasen-Netzen. Daraus lassen sich die Größen Wirk-, Blind- und Scheinleistung, Wirk- und Blindenergie, sowie der Leistungsfaktor und der Nullleiterstrom berechnen. In Verbindung mit Strom- und Spannungswandlern, deren Übersetzungsverhältnis zur direkten Anzeige aller Messdaten programmierbar ist, kann das Gerät Messungen in Nieder- und Mittelspannungsnetzen vornehmen. Das Gerät A 210/A 220 dient als Anzeiger mit zwei S0-Ausgängen bzw. Grenzwertmelder-Ausgängen.

Technische Daten

(detaillierte Angaben siehe Datenblatt, downloadbar unter www.camillebauer.com)

Messeingänge \rightarrow

Nennfrequenz: 50, 60 Hz
 Eingangsnennspannung: Leiter - Leiter: 500 V
 Leiter - N: 290 V
 Eingangsnennstrom: 5 A oder 1 A

Zulässige dauernd überhöhte Eingangsgrößen

10 A bei 346 V im Einphasennetz
 10 A bei 600 V im Drehstromnetz

Zulässige kurzzeitig überhöhte Eingangsgrößen

Überhöhte Eingangsgröße	Anzahl der Überhöhungen	Dauer der Überhöhungen	Zeitraum zwischen 2 aufeinanderfolgenden Überhöhungen
577 V LN	10	1 s	10 s
100 A	10	1 s	100 s
100 A	5	3 s	5 Min

Messbereiche

U, I, S: $\leq 120\%$ vom Nennwert
 P, Q: $\leq \pm 120\%$ vom Nennwert
 F: 45 bis 65 Hz
 $\cos\varphi$: ± 1

Impuls-/Grenzwertausgänge \rightarrow

Die beiden digitalen Ausgänge arbeiten je nach eingestellter Funktion entweder als Impulsausgang für Wirk- bzw. Blindenergie oder als Grenzwertmelder.

Die Ausgänge sind passiv und von allen anderen Kreisen durch Optokoppler galvanisch getrennt. Sie sind für die Ansteuerung von Tarifgeräten (S0-Norm DIN 43 864), oder von 24 V-Relais geeignet.

$U_{ext} \leq 40$ V DC (OFF: Leckstrom $\leq 0,1$ mA)
 $I_L \leq 150$ mA (ON: Klemmenspannung $\leq 1,2$ V)

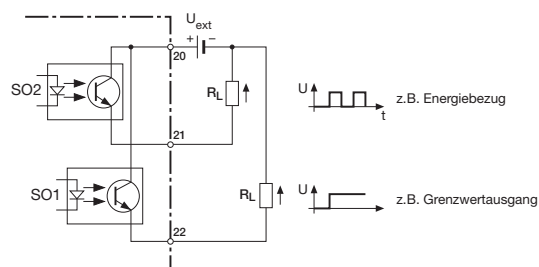

Grenzwertausgänge

Die Messgrößen können frei zugeordnet werden.

Impulsausgänge

Es können Wirk- und Blindenergie-Impulse zur Ansteuerung von elektronischen und elektromechanischen Zählern erzeugt werden.

Hilfsenergie \rightarrow

DC-, AC-Netzteil 50 bis 400 Hz
 100 bis 230 V AC/DC $\pm 15\%$ oder 24 bis 60 V AC/DC $\pm 15\%$
 (UL) 85 bis 125 V DC
 Leistungsaufnahme: 3 VA (ohne Erweiterungsmodul)



Zum Abschalten der Hilfsenergie ist in der Nähe des Gerätes eine gekennzeichnete, leicht erreichbare Schaltvorrichtung mit Strombegrenzung vorzusehen. Die Absicherung sollte 10 A oder weniger betragen und an die vorhandene Spannung und den Fehlerstrom angepasst sein.

Referenzbedingungen nach IEC 688 bzw. EN 60 688

Sinus 50 - 60 Hz, 15 - 30°, Anwendungsgruppe II

Messgenauigkeit (bezogen auf Nennwert)

Strom, Spannung $\pm 0,5\%$
 Leistung $\pm 1,0\%$
 Powerfaktor $\pm 1,0\%$
 Energie $\pm 1,0\%$
 Frequenz $\pm 0,02$ Hz (absolut)

Umgebungsbedingungen

Betriebstemperatur: -10 bis +55 °C
 Lagertemperatur: -25 bis +70 °C
 Relative Feuchtigkeit: $\leq 75\%$
 Betriebshöhe: 2000 m max.

Nur in Innenräumen zu verwenden

Sicherheit

Schutzklasse: II (Spannungseingänge mit Schutzimpedanz)

Messkategorie: III

Verschmutzungsgrad: 2

Bemessungsspannung: 300 V

Prüfspannungen: Zwischen Stromeingängen, Hilfsenergie, Digitalausgängen, Klemmen des aufgesetzten Steckmoduls: 3700 V / 50 Hz / 1 Min.

An Spannungseingängen: 4,25 kV 1,2/50 μ s

Modulanschluss: Die rückseitige Stiftleiste ist via Schutzimpedanz mit den Spannungseingängen verbunden. Es dürfen nur die zulässigen Module aufgesteckt werden!

Berührungsschutz: IP 20

Wartungshinweis

Das Leistungsmessgerät ist wartungsfrei.

Anzeige

Die Anzeige erfolgt 3-stellig bzw. 4-stellig (Frequenz) und rechtsbündig, mit Ausnahme der Energiewerte, deren Umfang 8 Stellen beträgt. Die linke 7-Segmentanzeige dient der Darstellung von Vorzeichen oder Abkürzungen.

Abkürzungen:

- Maximalwert
- Minimalwert
- Mittelwert
- max. Mittelwert
- Minimalwert für Powerfaktor; es wird der schlechteste der 3 Werte von P1, P2 und P3 angezeigt
- Nullleiterstrom
- Induktiv
- kapazitiv
- incoming, Bezug
- outgoing, Abgabe
- Intervall Wirkleistung
- Intervall Blindleistung

S **0** **0** **E** Intervall Scheinleistung
0 **0** letztes Intervall; t-0
0 **1**, **0** **2**... vorletztes Intervall; t-1, -2, -3, -4
0 **0** Overload, Überbereichsanzeige
 Σ Systemwert
 Δ Dreiecksspannung

Energiezähler

.H Hochtarif
.L Niedertarif

Aktuelle Zeit t	Intervall 0	Intervall 1	Intervall 2	Intervall 3	Intervall 4
t	t-0	t-1	t-2	t-3	t-4

Nullpunktunterdrückung

PF bzw. cos ϕ : Anzeige ---, wenn $S_x < 0,2\% S_{nenn}$
 Ströme: Anzeige 0, wenn $I_x < 0,1\% I_{nenn}$

Inbetriebnahme

Das Leistungsmessgerät kann durch Einschalten der Hilfsenergie in Betrieb genommen werden. Es erscheinen nacheinander folgende Anzeigen:

- Segmenttests:** Alle Segmente der Anzeige und alle LED's leuchten für 2 s.
- Softwareversion:** z.B. A 210 1.04
- Die 3 **Strangspannungen** bei der Erstinbetriebnahme.

Hilfsenergieausfall

Bei einem Hilfsenergieausfall bleiben alle programmierten Werte erhalten.
 Nach dem Wiederanlegen der Hilfsenergie wird der zuletzt gewählte **Modus** angezeigt.

Elektrische Anschlüsse



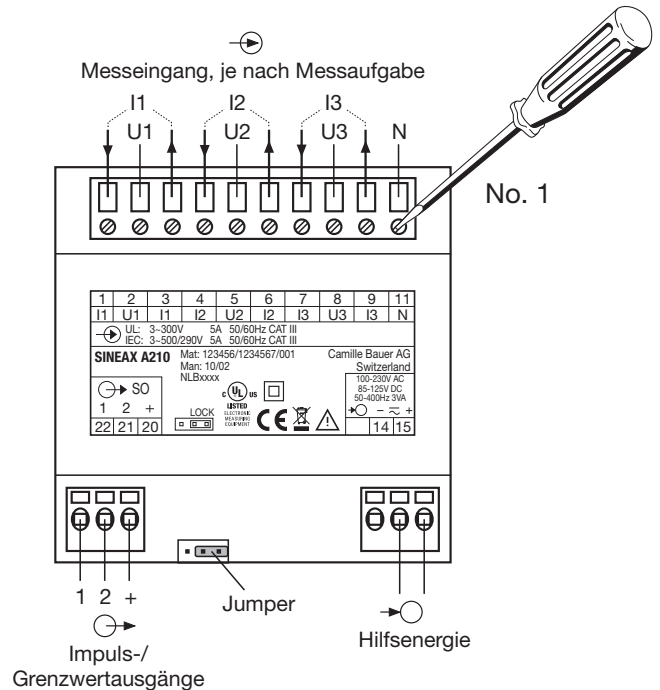

	Sicherheitsabschaltung Die Hauptstromversorgung zum Gerät muss einer nachgeschalteten Vorrichtung zur Strombegrenzung nachgeschaltet sein. Die elektrische Sicherung sollte 20 Ampere oder weniger betragen und für vorhandene Spannung und Fehlerstrom zulässig sein; verwenden Sie vorzugsweise 5-Ampere-Sicherungen.
	WARNUNG Die Hauptstromversorgung zum Gerät muss einer nachgeschalteten Vorrichtung zur Strombegrenzung nachgeschaltet sein. Die elektrische Sicherung sollte 20 Ampere oder weniger betragen und für vorhandene Spannung und Fehlerstrom zulässig sein; verwenden Sie vorzugsweise 5-Ampere-Sicherungen.
	Es sind die landesüblichen Vorschriften (z.B. in Deutschland VDE 0100 „Bedingungen über das Errichten von Starkstromanlagen mit Nennspannungen unter 1000 V“ bei der Installation und Auswahl des Materials der elektrischen Leitungen zu befolgen!
	Bei Verwendung externer Spannungs- und Stromwandler beachten Sie die Hersteller-Informationen für den Anschluss zur Spannungs- und Strom-Überwachung.



Abgebildet ist der SINEAX A 210. Die Anschlüsse sind jedoch beim SINEAX A 220 identisch.

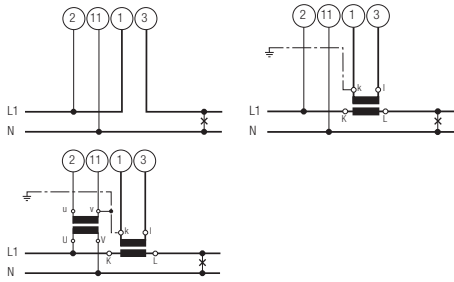

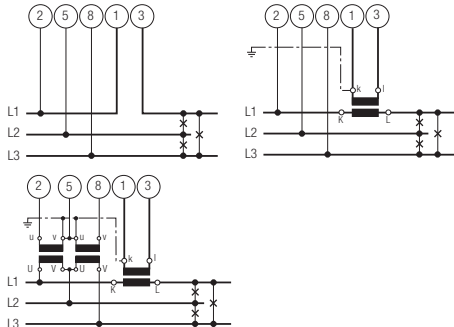
Symbol	Bedeutung
	Geräte dürfen nur fachgerecht entsorgt werden
	Doppelte Isolierung, Gerät der Schutzklasse 2
	CE-Konformitätszeichen. Das Gerät erfüllt die Bedingungen der zutreffenden EG-Richtlinien.
	Produkte mit dieser Kennzeichnung stimmen sowohl mit den kanadischen (CSA) als auch mit den amerikanischen Vorschriften (UL) überein
	Achtung! Allgemeine Gefahrenstelle. Betriebsanleitung beachten.
	Allgemeines Symbol: Eingang
	Allgemeines Symbol: Ausgang
	Allgemeines Symbol: Hilfsenergie-Versorgung
CAT III	Messkategorie CAT III für Strom- und Spannungseingänge

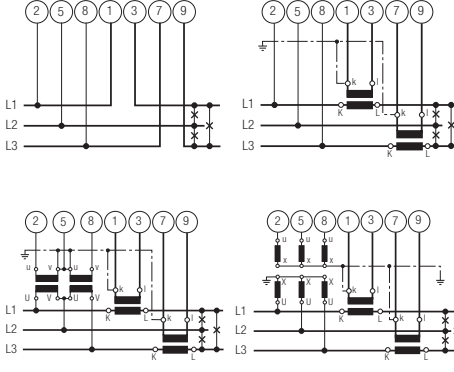
Anschlussarten

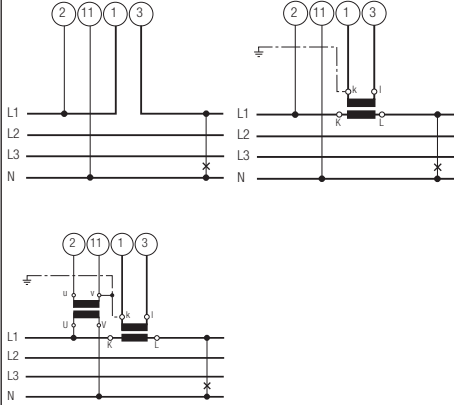
Netzformen/ Anwendung	Klemmenbelegung																		
Einphasen- Wechselstrom- netz 																			
Dreileiter- Drehstromnetz gleichbelastet I: L1 	 <p>Bei Strommessung über L2 bzw. L3, Spannungsanschluss nach folgender Tabelle vornehmen:</p> <table border="1"> <thead> <tr> <th>Strom- wandler</th> <th colspan="2">Klemmen</th> <th>2</th> <th>5</th> <th>8</th> </tr> </thead> <tbody> <tr> <td>L2</td> <td>1</td> <td>3</td> <td>L2</td> <td>L3</td> <td>L1</td> </tr> <tr> <td>L3</td> <td>1</td> <td>3</td> <td>L3</td> <td>L1</td> <td>L2</td> </tr> </tbody> </table>	Strom- wandler	Klemmen		2	5	8	L2	1	3	L2	L3	L1	L3	1	3	L3	L1	L2
Strom- wandler	Klemmen		2	5	8														
L2	1	3	L2	L3	L1														
L3	1	3	L3	L1	L2														
Dreileiter- Drehstromnetz ungleich- belastet 																			

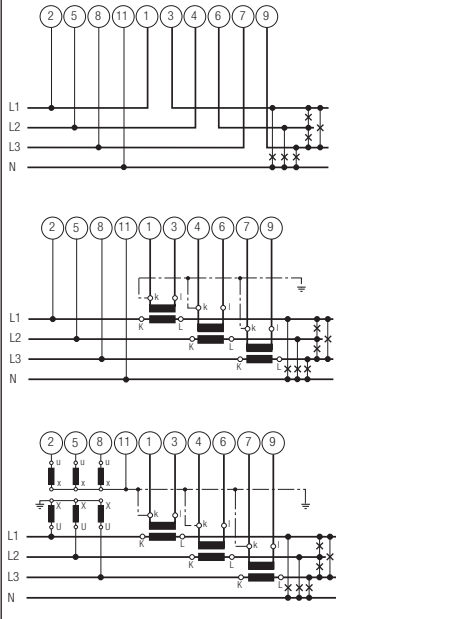
Netzformen/ Anwendung	Klemmenbelegung															
Vierleiter- Drehstromnetz gleichbelastet I: L1 	 <p>Bei Strommessung über L2 bzw. L3, Spannungsanschluss nach folgender Tabelle vornehmen:</p> <table border="1"> <thead> <tr> <th>Stromwandler</th> <th colspan="2">Klemmen</th> <th>2</th> <th>11</th> </tr> </thead> <tbody> <tr> <td>L2</td> <td>1</td> <td>3</td> <td>L2</td> <td>N</td> </tr> <tr> <td>L3</td> <td>1</td> <td>3</td> <td>L3</td> <td>N</td> </tr> </tbody> </table>	Stromwandler	Klemmen		2	11	L2	1	3	L2	N	L3	1	3	L3	N
Stromwandler	Klemmen		2	11												
L2	1	3	L2	N												
L3	1	3	L3	N												
Vierleiter- Drehstromnetz ungleich- belastet 	 <p>3 einpolig isolierte Spannungswandler im Hochspannungsnetz</p>															

Anzeige und Bedienung

(abgebildet ist der SINEAX A 210. Die Anzeige und die Bedienung sind jedoch beim SINEAX A 220 identisch.)

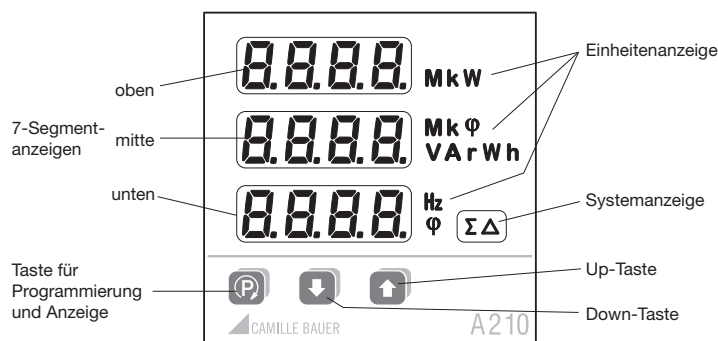

Verfügbare Messdaten	Beispiel Anzeige oben	Beispiel Anzeige mitte	Beispiel Anzeige unten	Einheiten-anzeige	System-anzeige
Phasenspannungen U1, U2, U3	230	231	229	V	
Maximalwerte U1 _{max.} , U2 _{max.} , U3 _{max.}	235	236	231	V	
Minimalwerte U1 _{min.} , U2 _{min.} , U3 _{min.}	227	226	225	V	
Dreieckspannungen U12, U23, U31	400	402	398	V	Δ
Maximalwerte U12 _{max.} , U23 _{max.} , U31 _{max.}	405	406	403	V	Δ
Minimalwerte U12 _{min.} , U23 _{min.} , U31 _{min.}	395	397	396	V	Δ
Phasenströme I1, I2, I3	2.35	2.37	2.34	A	
Maximalwerte I1 _{max.} , I2 _{max.} , I3 _{max.}	2.39	2.40	2.38	A	
Mittelwert I1 _{avg.} , I2 _{avg.} , I3 _{avg.} (Bimetall-15 Min.)	2.04	2.05	2.07	A	
Max. Mittelwert I1 _{avgmax.} , I2 _{avgmax.} , I3 _{avgmax.} (Schleppzeiger-15 Min.)	2.07	2.05	2.04	A	
Nullleiterstrom IN	0.00	0.45		A	
Wirkleistungen P1, P2, P3	56.1	56.2	56.5	kW	
Maximalwerte P1 _{max.} , P2 _{max.} , P3 _{max.}	60.5	60.4	60.3	kW	
Wirkleistung System P		125		kW	Σ
Maximalwert P _{max.}		239		kW	Σ
Blindleistungen Q1, Q2, Q3	1.24	1.23	1.22	VAr	
Maximalwerte Q1 _{max.} , Q2 _{max.} , Q3 _{max.}	1.51	1.52	1.54	VAr	
Blindleistung System Q		1.54		VAr	Σ
Maximalwert Q _{max.}		2.31		VAr	Σ
Scheinleistungen S1, S2, S3	2.56	2.58	2.60	VA	
Maximalwerte S1 _{max.} , S2 _{max.} , S3 _{max.}	3.43	3.44	3.67	VA	
Scheinleistung System S		5.33		VA	
Maximalwert S _{max.}		6.23		VA	Σ
Powerfaktor PF1, cosφ	0.87	0.87	0.87	φ	
Powerfaktor PF2, cosφ	0.88	0.88	0.88	φ	
Powerfaktor PF3, cosφ	0.89	0.89	0.89	φ	
Powerfaktor System PF, cosφ	0.88	0.88	0.88	φ	Σ
Minimalwert Powerfaktor induktiv	0.76	0.76	0.76	φ	Σ
Minimalwert Powerfaktor kapazitiv	0.84	0.84	0.84	φ	Σ
Frequenz, F			49.99	Hz	
Wirkenergie Bezug EP Hochtarif	4589	2356	0.00	kWh	Σ
Wirkenergie Bezug EP Niedertarif *)	1234	5678	0.00	kWh	Σ
Wirkenergie Abgabe EP Hochtarif	4589	2356	0.00	kWh	Σ
Wirkenergie Abgabe EP Niedertarif *)	1234	5678	0.00	kWh	Σ
Blindenergie induktiv EQ Hochtarif	9876	5432	0.00	kVarh	Σ
Blindenergie induktiv EQ Niedertarif *)	1234	9876	0.00	kVarh	Σ
Blindenergie kapazitiv EQ Hochtarif	9876	5432	0.00	kVarh	Σ
Blindenergie kapazitiv EQ Niedertarif *)	1234	9876	0.00	kVarh	Σ
5 Wirkleistungs-Intervalle Pint0, Pint1, ...	234	234	0.00	kW	Σ
5 Blindleistungs-Intervalle Quint0, Quint1, ...	123	123	0.00	VAr	Σ
5 Scheinleistungs-Intervalle Sint0, Sint1, ...	10.1	10.1	0.00	VA	Σ

*) Tarumschaltung nur mit Digitaleingang möglich (optionales Erweiterungsmodul)

Berechnung der Messgrößen

Die Berechnung der Messgrößen erfolgt nach DIN 40 110, mit Ausnahme der Blindleistung. Der SINEAX A 210/A 220 berechnet diese mit Vorzeichen.

Messumformer bzw. Anzeiger können im gleichen Netz u.U. verschiedene Werte für die Blindleistung anzeigen.

Der Grund sind die unterschiedlichen Berechnungsarten.

Powerfaktor cosφ 4-Quadranten-darstellung

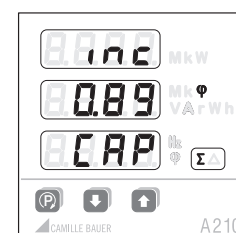

System

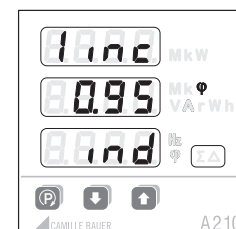

Phase 1

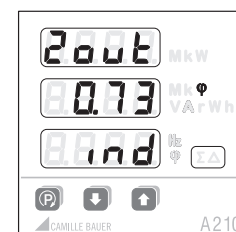

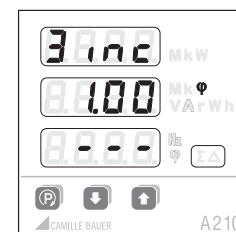

Phase 2





Phase 3

Anzeigeebenen



Innerhalb einer Ebene (1, 2, 3 ...) können Sie mit der  Taste die 3 Anzeigen in den nächsten Modus (a, b, c, ...) umschalten. Am Ende des Modus beginnt die Anzeige wieder mit dem Modus a.

In die nächste Ebene wechseln Sie durch kurzes Drücken der  und  Tasten.

Vierleiter ungleichbelastet

								
		a	b	c	d	e	f	
 	1	U1 U2 U3	U1 _{max.} U2 _{max.} U3 _{max.}	U1 _{min.} U2 _{min.} U3 _{min.}	U12 U23 U31	U12 _{max.} U23 _{max.} U31 _{max.}	U12 _{min.} U23 _{min.} U31 _{min.}	
	2	I1 I2 I3	I1 _{max.} I2 _{max.} I3 _{max.}	I1 _{avg.} I2 _{avg.} I3 _{avg.}	I1 _{avgmax.} I2 _{avgmax.} I3 _{avgmax.}	IN	IN _{max.}	
	3	P1 P2 P3	P1 _{max.} P2 _{max.} P3 _{max.}	P	P _{max.}			
	4	Q1 Q2 Q3	Q1 _{max.} Q2 _{max.} Q3 _{max.}	Q	Q _{max.}			
	5	S1 S2 S3	S1 _{max.} S2 _{max.} S3 _{max.}	S	S _{max.}			
	6	PF1	PF2	PF3	PF	PF _{minind}	PF _{mincap}	
	7	F						
	8	EP inc HT ¹	EP inc LT ²	EP out HT ¹	EP out LT ²			
	9	EQ ind HT ¹	EQ ind LT ²	EQ cap HT ¹	EQ cap LT ²			
	10	P Q PF	P S F					
	11	Pint0	Pint1	Pint2	Pint3	Pint4		
	12	Qint0	Qint1	Qint2	Qint3	Qint4		
	13	Sint0	Sint1	Sint2	Sint3	Sint4		

Einphasig, Dreileiter gleichbelastet, Vierleiter gleichbelastet

						
		a	b	c	d	e
 	1	U	U _{max.}	U _{min.}		
	2	I	I _{max.}	I _{avg.}	I _{avgmax.}	
	3	P	P _{max.}			
	4	Q	Q _{max.}			
	5	S	S _{max.}			
	6	PF	PF _{minind}	PF _{mincap}		
	7	F				
	8	EP inc HT ¹	EP inc NT ²	EP out HT ¹	EP out NT ²	
	9	EQ ind HT ¹	EQ ind NT ²	EQ cap HT ¹	EQ cap NT ²	
	10	P Q PF	P S F			
	11	Pint0	Pint1	Pint2	Pint3	Pint4
	12	Qint0	Qint1	Qint2	Qint3	Qint4
	13	Sint0	Sint1	Sint2	Sint3	Sint4

Bedienung

Helligkeit

13 Stufen: Längeres Drücken der Tasten  (dunkler)  (heller).



Löschen / Clear

Gleichzeitiges Drücken der Tasten   löscht die min- bzw. max-Werte bzw. die Energiewerte der angezeigten Grössen.

Verriegelung

Die Rückstellfunktion für die Energiezähler kann gesperrt werden, indem der Jumper auf der Geräterückseite in Position LOCK gebracht wird.

Dreileiter ungleichbelastet

						
		a	b	c	d	e
 	1	U12 U23 U31	U12 _{max.} U23 _{max.} U31 _{max.}	U12 _{min.} U23 _{min.} U31 _{min.}		
	2	I1 I2 I3	I1 _{max.} I2 _{max.} I3 _{max.}	I1 _{avg.} I2 _{avg.} I3 _{avg.}	I1 _{avgmax.} I2 _{avgmax.} I3 _{avgmax.}	
	3	P	P _{max.}			
	4	Q	Q _{max.}			
	5	S	S _{max.}			
	6	PF	PF _{minind}	PF _{mincap}		
	7	F				
	8	EP inc HT ¹	EP inc LT ²	EP out HT ¹	EP out LT ²	
	9	EQ ind HT ¹	EQ ind LT ²	EQ cap HT ¹	EQ cap LT ²	
	10	P Q PF	P S F			
	11	Pint0	Pint1	Pint2	Pint3	Pint4
	12	Qint0	Qint1	Qint2	Qint3	Qint4
	13	Sint0	Sint1	Sint2	Sint3	Sint4

¹ HT = Hochtarif

² LT = Niedertarif

Programmierung

Alle Parameter lassen sich jederzeit anzeigen. Für Veränderungen muss aber der Jumper auf der Rückseite des Gerätes gezogen sein (Stellung nicht auf LOCK).

Die folgende Tabelle zeigt alle Parameter mit ihren einstellbaren Bereichen bzw. den möglichen Selektionen. Die schwarzen Nummern geben einen Querverweis auf die entsprechende Stelle im Diagramm auf Seite 30.

Von der Messwert-Anzeige gelangt man durch langes Drücken der Taste **(P)** in die Menü-Ebene.

Danach kann durch weiteres kurzes Drücken der Taste **(P)** der gewünschte Menüpunkt angewählt werden.

Mit der Taste **(↓)** gelangt man in die Parameter-Ebene, wo der gewünschte Parameter angezeigt werden kann.

Durch kurzes Drücken der Taste **(P)** beginnt das wählbare Element zu blinken.

Der blinkende Inhalt kann mit den Tasten **(↓)** / **(↑)** verändert werden.

Die Parameter- oder Menü-Ebene wird durch langes Drücken der Taste **(P)** wieder verlassen.

Die Einstellungen bleiben danach auch bei Versorgungsausfall gespeichert.

Hinweise:

Die Anschlussart und die Wandlerfaktoren müssen immer zuerst eingestellt werden, weil die Messwertanzeigen, Grenzwerteinstellungen etc. davon abhängig sind.

Die Programmierung kann auch über ein Erweiterungsmodul (Option) verändert werden.

Sperren der Programmierung

Jumper in Stellung LOCK.

Die Programmierung aller Werte ist blockiert.







































Werkseinstellungen

Helligkeit: (mittlerer Wert)
 Grenzwert / S01: Off
 Grenzwert / S02: Off
 Wandlerverhältnis: 1 : 1
 Jumper: Nicht in Stellung LOCK
 Anschlussart: Vierleiter ungleichbelastet
 Synchron-Intervall: 15 min.

Übersicht der Parameter

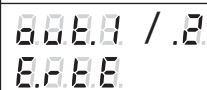
Nr.	Anzeige oben Anzeige mitte	Anzeige unten (Auswahl, * = Default)	Bedeutung	Hinweis
1			Anschlussart	
		*	Vierleiternetz ungleich belastet	(4 lines unbalanced)
			Dreileiternetz ungleich belastet	(3 lines unbalanced)
			Vierleiternetz gleich belastet	(4 lines balanced)
			Dreileiternetz gleich belastet	(3 lines balanced)
2			Belastungsart bei NetZRückspeisung: mathematisch	4-Quadrantenanzeige Ind-Cap-Ind-Cap
			Belastungsart bei NetZRückspeisung: elektrisch	4-Quadrantenanzeige Ind-Ind-Cap-Cap
3		kV [*] 100 V bis 999 kV	Primär-Spannung des externen Wandlers am Spannungseingang (Dreieckspannung)	Zuerst kann eine beliebige 3-stellige Zahl und danach die zugehörige Grösseneinheit in Schritten von Faktor 10 eingegeben werden
4		v [*] 100 V bis 999 V	Sekundär-Spannung des externen Wandlers am Spannungseingang (Dreieckspannung)	
5		A [*] 1,00 A bis 999 kA	Primär-Strom des externen Wandlers am Stromeingang	
6		A [*] 0,1 A bis 9,99 A	Sekundär-Strom des externen Wandlers am Stromeingang	



Nr.	Anzeige oben Anzeige mitte	Anzeige unten (Auswahl, * = Default)	Bedeutung	Hinweis		
7			Betriebsart der beiden Digitalausgänge «out.1» und «out.2»	(Mode)		
			Ausgang ausgeschaltet	Ansteuerung via Bus-Schnittstelle bleibt jedoch möglich		
			Energie-Impuls-Ausgang	Der Ausgang erzeugt Energie-Impulse mit der unter 12 eingestellten Impulsrate. Die auszugebende Zählergrösse kann unter 11 ausgewählt werden.		
			Alarm-Ausgang	Bei Überschreitung des Grenzwertes 9 wird der Ausgang aktiv (Strom fliesst). Bei Unterschreitung von 10 wird der Ausgang passiv. Die Quelle der überwachten Messgrösse ist in 8 festgelegt.		
8			Quelle der Alarmüberwachung	Diese Auswahl wird angeboten, wenn zuvor die Betriebsart 7 auf ALM gesetzt wurde		
				Line Type		
				'1L', '3Lb', '4Lb'	'3Lu'	'4Lu'
			Frequenz	●	●	●
			Nulleiterstrom			●
			Intervall-Scheinleistung	●	●	●
			Intervall-Blindleistung	●	●	●
			Intervall-Wirkleistung	●	●	●
			Powerfaktor (cos φ)	●	●	○
			Scheinleistung	●	●	○
			Blindleistung	●	●	○
			Wirkleistung	●	●	○
			Spannung	●		
			Phasenspannung			○
			Dreieckspannung		○	○
	Phasenstrom Average (Bimetal)	●	○	○		
	Phasenstrom	●	○	○		
				○: 'A.on' = OR-Verknüpfung der Phasengrössen 'A.off' = AND-Verknüpfung der Phasengrössen		
9			Einschaltgrenze für Alarm	Der maximale Wert richtet sich nach dem möglichen Messbereich und ist abhängig von den gewählten Wandlerfaktoren und Anschlussarten.		
10			Ausschaltgrenze nach Alarm			



Nr.	Anzeige oben Anzeige mitte	Anzeige unten (Auswahl, * = Default)	Bedeutung	Hinweis
11			Quelle des Energiezählers für Impulsausgang	
			Blindenergie kapazitiv Niedertarif	
			Blindenergie kapazitiv Hochtarif	
			Blindenergie induktiv Niedertarif	
			Blindenergie induktiv Hochtarif	
			Wirkenergie Abgabe Niedertarif	(outgoing low tariff)
			Wirkenergie Abgabe Hochtarif	(outgoing high tariff)
			Wirkenergie Bezug Niedertarif	(incoming low tariff)
	Wirkenergie Bezug Hochtarif	(incoming high tariff)		
12		 M ^k Wh [*]	Anzahl Impulse pro angezeigte Energie einheit. Nach Eingabe der Zahl 1 bis 5000 kann noch die Skalierung Grundeinheit (-), Kilo (k), Mega (M) und Giga (Mk) eingegeben werden	(energy rate)
		1 bis 5000 / Wh bis GWh		
13		 * 1 bis 60 Minuten	Zeitintervall in Minuten für die Berechnung der Intervall-Leistungen 0 = Intervall über Bus gesteuert	Bei externer Synchronisation ist der angezeigte Wert irrelevant.



Beispiele

Beispiel 1: Programmierung der Anschlussart
(3-Leiter ungleich belastet)

1.  -Taste drücken > 2 s

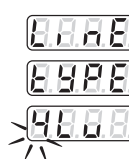

2.  -Taste drücken (zeigt aktuelle Einstellung)

3.  -Taste drücken (programmierbare Größe blinkt)

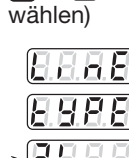

4.  /  -Taste drücken (gewünschten Parameter wählen)





5.  -Taste drücken (Programmierung übernehmen). Die Anzeige blinkt nun nicht mehr.

6.  -Taste drücken > 2 s (Rückkehr in die Anzeige-Ebene)

Beispiel 2: Programmierung Spannungs-Wandlerverhältnis und Energieintervall

1.  -Taste drücken > 2 s

2.  -Taste drücken (Menü Wandlerfaktoren)



3. -Taste drücken (aktuelle Einstellung Primärspannung)
4. -Taste drücken (linke Ziffer blinkt)
5. bzw. -Taste drücken bis gewünschte Ziffer erscheint
6. -Taste drücken (mittlere Ziffer blinkt)
7. bzw. -Taste drücken bis gewünschte Ziffer erscheint
8. -Taste drücken (rechte Ziffer blinkt)
9. bzw. -Taste drücken bis gewünschte Ziffer erscheint
10. -Taste drücken (Dezimalpunkt blinkt)
11. bzw. -Taste drücken bis Dezimalpunkt an gewünschter Stelle ist und die Kilo/Mega-Symbole stimmen
12. -Taste drücken (Programmierung übernehmen). Die Anzeige blinkt nun nicht mehr
13. -Taste drücken (aktuelle Einstellung Sekundärspannung)
14. Programmierung wie Primärspannung (Punkt 1 bis 12)
15. -Taste drücken bis in der oberen Anzeige erscheint

16. -Taste 3x drücken
17. -Taste drücken (aktuelle Einstellung in Minuten)
18. -Taste drücken (linke Ziffer blinkt)
19. bzw. -Taste drücken bis gewünschte Ziffer erscheint
20. -Taste drücken (rechte Ziffer blinkt)
21. bzw. -Taste drücken bis gewünschte Ziffer erscheint
22. -Taste drücken (Programmierung übernehmen). Die Anzeige blinkt nun nicht mehr
23. -Taste > 2 s drücken (Rückkehr in die Anzeigebene)

Description brève

Les appareils A210/A220 sont des instruments pour montage encastré du format 96 x 96 mm (A 210) ou 144 x 144 mm (A 220) et sert à l'analyse de réseaux de courant alternatif. Il capte les tensions, les courants, la fréquence et l'angle de phase de réseaux mono- et triphasés. Ainsi, il est possible de calculer les grandeurs suivantes: puissance active, réactive et apparente, énergies active et réactive, facteur de puissance et courant du neutre. En connexion avec des transformateurs d'intensité et de tension avec rapports programmables, l'appareil peut être utilisé dans des réseaux à moyenne et basse tension. L'appareil sert à l'affichage avec deux sorties S0 resp. détecteurs de valeur limite.

Caractéristiques techniques

(Pour plus de détails, voir notice A210/A220 Lf, download sous www.camillebauer.com)

Entrées de mesure

Fréquence nominale: 50, 60 Hz
Tension nominale d'entrée: Phase-phase: 500 V
Phase-neutre: 290 V
Courant nominal d'entrée: 5 A ou 1 A

Augmentation perm. admissible des grand. d'entrée

10 A à 346 V dans réseau monophasé
10 A à 600 V dans réseau de courant triphasé

Augmentation temp. admissible des grand. d'entrée

Grandeur d'entrée augmentée	Nombre d'augmentations de valeur	Durée des augmentations	Intervalle entre deux augmentations successives
577 V LN	10	1 s	10 s
100 A	10	1 s	100 s
100 A	5	3 s	5 min

Etendues de mesure

U, I, S: $\leq 120\%$ de la valeur nominale
P, Q: $\leq \pm 120\%$ de la valeur nominale
F: 45 à 65 Hz
 $\cos\varphi$: ± 1

Sorties d'impulsions, sorties de valeur limite

Les deux sorties numériques travaillent suivant la fonction choisie soit sous forme d'impulsions pour l'énergie active resp. réactive, soit comme détecteur de valeur limite.

Les sorties sont passives et séparées de tous les autres circuits par des coupleurs optoélectroniques. Ils peuvent activer des compteurs tarifaires (S0-standard DIN 43 864) ou des relais 24 V.

$U_{ext} \leq 40$ V CC (OFF: Courant de fuite $\leq 0,1$ mA)
 $I_L \leq 150$ mA (ON: Tension des bornes $\leq 1,2$ V)

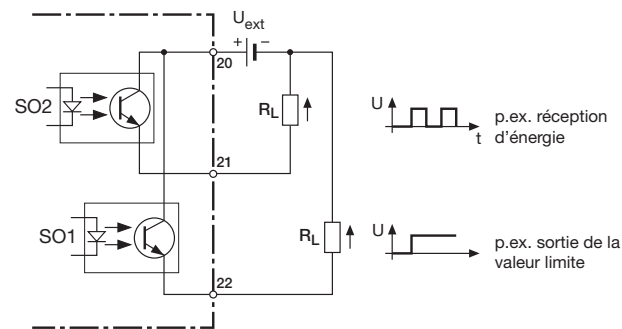

Sorties de valeurs limites

Les grandeurs de mesures peuvent librement être attribuées.

Sorties d'impulsions

Permettent de générer des impulsions de valeurs d'énergie active et réactive pour alimenter des compteurs électromécaniques ou électroniques.

Energie auxiliaire

Bloc d'alimentation CC, CA 50 à 400 Hz
100 à 230 V CA/CC $\pm 15\%$ ou 24 à 60 V CA/CC $\pm 15\%$
(UL) 85 à 125 V CC
Consommation: 3 VA (sans module d'extension)



Un interrupteur, repéré et facile d'accès, coupant l'alimentation auxiliaire doit être installé à proximité de l'appareil.
La protection électrique doit être de 10 A ou moins et être adaptée à la tension et au courant de défaut disponibles.

Conditions de référence selon CEI 688 resp. EN 60 688

Sinusoidal 50 - 60 Hz, 15 - 30°, groupe d'utilisation II

Précision (par rapport aux valeurs nominales)

Courant, tension $\pm 0,5\%$
Puissance $\pm 1,0\%$
Facteur de puissance $\pm 1,0\%$
Energie $\pm 1,0\%$
Fréquence $\pm 0,02$ Hz (absolut)

Ambiance extérieure

Temp. de fonctionnement: -10 à +55 °C
Température de stockage: -25 à +70 °C
Humidité relative: $\leq 75\%$
Altitude: 2000 m max.
Utiliser seulement dans les intérieurs

Sécurité

Classe de protection: II (entrées de tension avec impédances de protection)
Catégorie de mesure: III
Degré d'encrassement: 2
Tension de référence: 300 V
Tensions d'essai: Entre entrées courant, tension d'alimentation, sorties numérique, bornes du module embrochable: 3700 V / 50 Hz / 1 min.
Aux entrées de tension: 4,25 kV 1,2/50 μ s
Raccordement du module: La barre des broches au dos de l'appareil et connectée à travers une impédance de protection aux entrées tension. Seulement des modules approuvés doivent être embrochés!
Protection: IP 20

Conseils pour la maintenance

L'indicateur de puissances ne nécessite pas d'entretien.

Affichage

L'affichage est réalisé en partent de la droite à 3 chiffres, resp. 4 chiffres pour la fréquence à l'exception des valeurs d'énergie qui elles comportent 8 chiffres. L'affichage à 7 segments toute à gauche permet l'indiction de signes resp. d'abréviations.

Abréviations:

Valeur maximale
 Valeur minimale
 Valeur moyenne
 Valeur moyenne maximum
 Valeur minimum pour facteur de puissance la valeurs la plus mauvaise des 3 P1, P2 et P3 est affichée
 Courant du neutre
 Inductive
 Capacitive
 incoming, reçu
 outgoing, fourni
 Intervalle puissance active
 Intervalle puissance réactive

50RE	Intervalle puissance apparente
0	dernier intervalle; t-0
01, 02...	avant-dernier intervalle; t-1, -2, -3, -4
OL	Overload, affichage de dépassement d'étendue
Σ	Valeur du système
Δ	Tensions entre phases

Compteur d'énergie

.H	Valeur du système
.L	Tensions entre phases

	Intervalle 0	Intervalle 1	Intervalle 2	Intervalle 3	Intervalle 4
Temps actuel t	t-0	t-1	t-2	t-3	t-4

Suppression du point zéro

PF resp. $\cos\varphi$: Indication ---, si $S_x < 0,2\%$ S_{nenn}

Courants: Indication 0, si $I_x < 0,1\%$ I_{nenn}

Mise en service

L'indicateur de puissances peut être mis en service par l'enclenchement de l'alimentation auxiliaire. les affichages suivants se succèdent alors:

1. **Test des segments:** Tous les segments de l'affichage et toutes les DEL s'allument pour 2 s.
2. **Version du logiciel:** p. ex. A 210 1.04
3. Les 3 **tensions de phase** lors de la première mise en service.

Coupure de l'énergie auxiliaire

En cas de coupure de l'énergie auxiliaire, toutes les valeurs programmées restent en mémoire. Après le réenclenchement de l'énergie auxiliaire, le dernier **mode** de fonctionnement est affiché.

Raccordements électriques



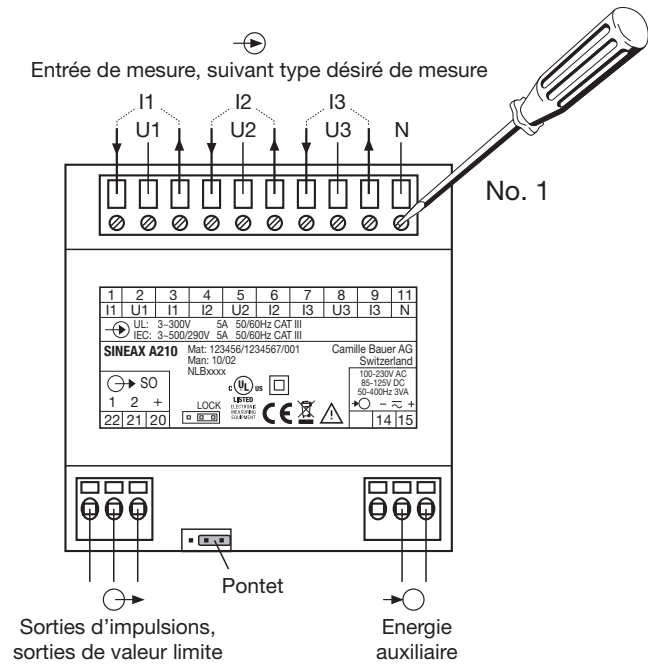

	Coupure de sécurité L'alimentation électrique principale allant vers l'appareil doit être montée en aval d'un dispositif limiteur de courant. La protection électrique doit être de 20 ampères ou moins et être autorisée pour la tension et le courant de défaut disponibles; utilisez de préférence des fusibles 5 ampères.
	AVERTISSEMENT L'alimentation électrique principale allant vers l'appareil doit être montée en aval d'un dispositif limiteur de courant. La protection électrique doit être de 20 ampères ou moins et être autorisée pour la tension et le courant de défaut disponibles; utilisez de préférence des fusibles 5 ampères.
	D'autre part, la réglementation nationale (p.ex. en Allemagne VDE 0100 „Conditions concernant la réalisation d'installations à courants forts sous tension nominale inférieure à 1000 V“) doit être observée dans l'installation et le choix du matériel des lignes électriques!
	Si vous utilisez un transformateur de tension et de courant, respectez les informations fournies par le fabricant à propos du raccordement de la surveillance de la tension et du courant.



Les raccordements électriques pour SINEAX A 210 et A 220 sont identiques.

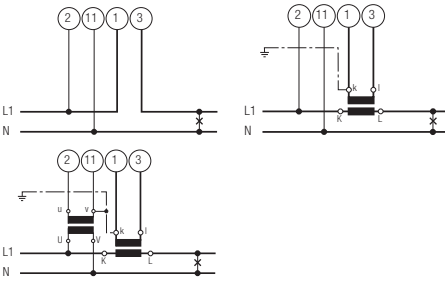

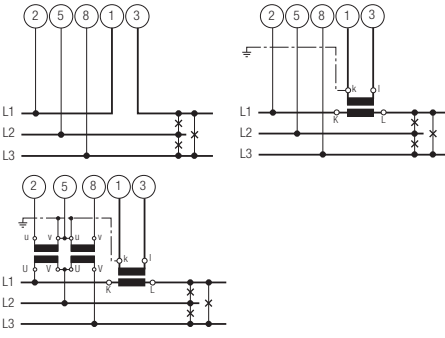
Symbole	Signification
	Les appareils ne peuvent être éliminés que de façon appropriée!
	Double isolation, appareil de classe de protection 2
	Marquage CE de conformité: l'appareil répond aux exigences des directives CE applicables
	Les produits portant ce marquage sont conformes aux prescriptions canadiennes (CSA) et américaines (UL)
	Attention: Avertit l'utilisateur d'un danger. Attention, voir la documentation!
	Symbole général: Entrée
	Symbole général: Sortie
	Symbole général: Energie auxiliaire
CAT III	Catégorie de mesure CAT III pour entrée de courant et de tension

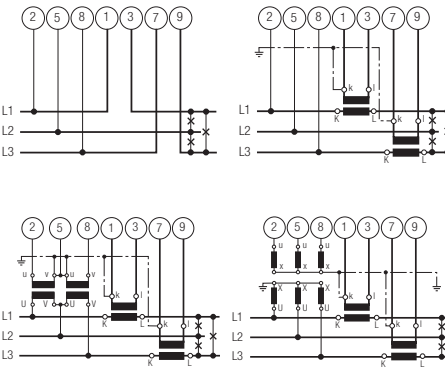
Possibilités de raccordement

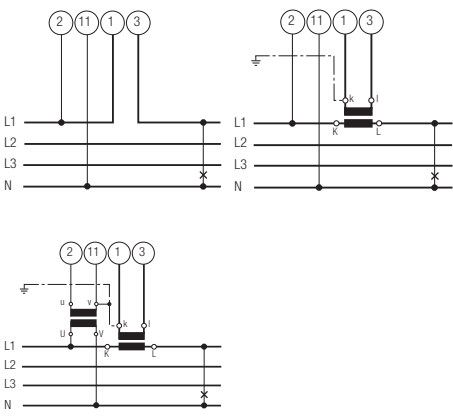
Réseau/ Application	Disposition des bornes																		
<p>Courant alternatif monophasé</p> 																			
<p>Courant triphasé 3 fils à charges équilibrées I: L1</p> 	 <p>Pour la mesure du courant en L2 resp. L3, connecter les tensions selon tableau ci-après:</p> <table border="1"> <thead> <tr> <th>Transformateur de courant</th> <th colspan="2">Bornes</th> <th>2</th> <th>5</th> <th>8</th> </tr> </thead> <tbody> <tr> <td>L2</td> <td>1</td> <td>3</td> <td>L2</td> <td>L3</td> <td>L1</td> </tr> <tr> <td>L3</td> <td>1</td> <td>3</td> <td>L3</td> <td>L1</td> <td>L2</td> </tr> </tbody> </table>	Transformateur de courant	Bornes		2	5	8	L2	1	3	L2	L3	L1	L3	1	3	L3	L1	L2
Transformateur de courant	Bornes		2	5	8														
L2	1	3	L2	L3	L1														
L3	1	3	L3	L1	L2														
<p>Courant triphasé 3 fils à charges dés-équilibrées</p> 																			

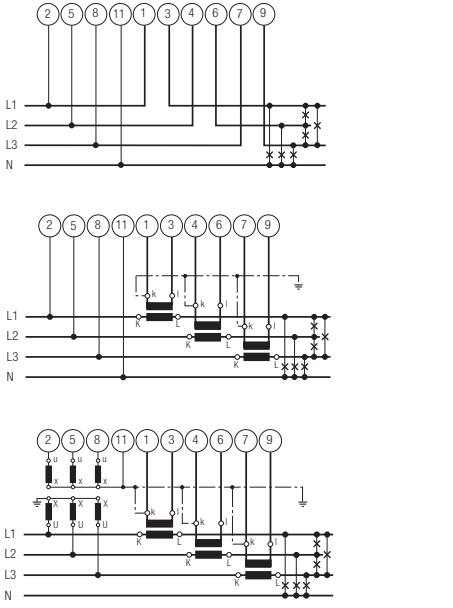
Réseau/ Application	Disposition des bornes															
<p>Courant triphasé 4 fils à charges équilibrées I: L1</p> 	 <p>Pour la mesure du courant en L2 resp. L3, connecter les tensions selon tableau ci-après:</p> <table border="1"> <thead> <tr> <th>Transformateur de courant</th> <th colspan="2">Bornes</th> <th>2</th> <th>11</th> </tr> </thead> <tbody> <tr> <td>L2</td> <td>1</td> <td>3</td> <td>L2</td> <td>N</td> </tr> <tr> <td>L3</td> <td>1</td> <td>3</td> <td>L3</td> <td>N</td> </tr> </tbody> </table>	Transformateur de courant	Bornes		2	11	L2	1	3	L2	N	L3	1	3	L3	N
Transformateur de courant	Bornes		2	11												
L2	1	3	L2	N												
L3	1	3	L3	N												
<p>Courant triphasé 4 fils à charges dés-équilibrées</p> 	 <p>3 transformateurs de tensions unipolaires isolés pour réseau haute tension</p>															

Affichage et utilisation

L'affichage et utilisation pour SINEAX A 210 et A 220 sont identiques.

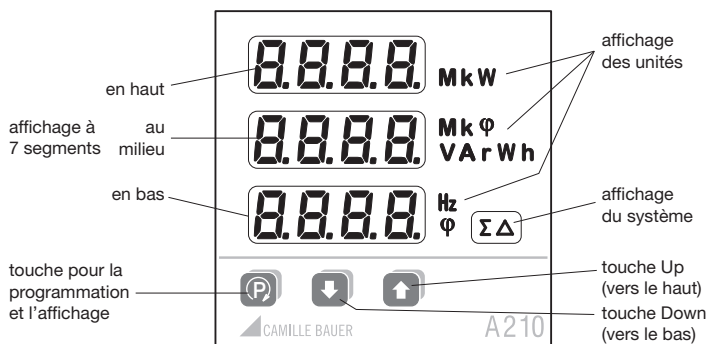

Facteur de puissance cosφ mode 4 quadrants

Données de mesure disponibles	Exemple Affichage en haut	Exemple Affichage au centre	Exemple Affichage en bas	Affichage unités	Affichage système
Tensions des phases U1, U2, U3	230	231	229	V	
Valeurs maximum U1 _{max.} , U2 _{max.} , U3 _{max.}	235	236	231	V	
Valeurs minimum U1 _{min.} , U2 _{min.} , U3 _{min.}	227	226	225	V	
Tensions entre phases U12, U23, U31	400	402	398	V	Δ
Valeurs maximum U12 _{max.} , U23 _{max.} , U31 _{max.}	405	406	403	V	Δ
Valeurs minimum U12 _{min.} , U23 _{min.} , U31 _{min.}	395	397	396	V	Δ
Courants des phases I1, I2, I3	2.35	2.37	2.34	A	
Valeurs maximum I1 _{max.} , I2 _{max.} , I3 _{max.}	2.39	2.40	2.38	A	
Valeur moyenne I1 _{avg.} , I2 _{avg.} , I3 _{avg.} (bimétablique -15 min.)	2.04	2.05	2.07	A	
Val. moyenne max. I1 _{avgmax.} , I2 _{avgmax.} , I3 _{avgmax.} (aiguille entraînée -15 min.)	2.07	2.05	2.04	A	
Courant du neutre IN	0.45	0.45	0.45	A	
Puissances active P1, P2, P3	56.1	56.2	56.5	kW	
Valeurs maximum P1 _{max.} , P2 _{max.} , P3 _{max.}	60.5	60.4	60.3	kW	
Puissance active, système P		125		kW	Σ
Valeur maximum P _{max.}		239		kW	Σ
Puissance réactive Q1, Q2, Q3	1.24	1.23	1.22	VAR	
Valeurs maximum Q1 _{max.} , Q2 _{max.} , Q3 _{max.}	1.51	1.52	1.54	VAR	
Puissance réactive système Q		1.54		VAR	Σ
Valeur maximum Q _{max.}		2.31		VAR	Σ
Puissances apparente S1, S2, S3	2.56	2.58	2.60	VA	
Valeurs maximum S1 _{max.} , S2 _{max.} , S3 _{max.}	3.43	3.44	3.67	VA	
Puissance apparente système S		5.33		VA	
Valeur maximum S _{max.}		6.23		VA	Σ
Facteur de puissance PF1, cosφ	0.87	0.87	0.87	φ	
Facteur de puissance PF2, cosφ	0.88	0.88	0.88	φ	
Facteur de puissance PF3, cosφ	0.89	0.89	0.89	φ	
Facteur de puissance système PF, cosφ	0.88	0.88	0.88	φ	Σ
Valeur min. facteur de puissance inductif	0.76	0.76	0.76	φ	Σ
Valeur min. facteur de puissance capacitif	0.84	0.84	0.84	φ	Σ
Fréquence, F			49.99	Hz	
Energie active reçue EP tarif normal	4589	2356	4589	kWh	Σ
Energie active reçue EP tarif réduit *)	1234	5678	1234	kWh	Σ
Energie active fournie EP tarif normal	4589	2356	4589	kWh	Σ
Energie active fournie EP tarif réduit *)	1234	5678	1234	kWh	Σ
Energie réactive inductive EQ tarif normal	9876	5432	9876	kVarh	Σ
Energie réactive inductive EQ tarif réduit *)	1234	9876	1234	kVarh	Σ
Energie réactive capacitive EQ tarif normal	9876	5432	9876	kVarh	Σ
Energie réact. capacitive EQ tarif réduit *)	1234	9876	1234	kVarh	Σ
5 intervalle puiss. active Pint0, Pint1, ...	234	234	234	kW	Σ
5 intervalle puiss. réactive Quint0, Quint1, ...	123	123	123	VAR	Σ
5 intervalle puissance apparente Sint0, Sint1, ...	10.1	10.1	10.1	VA	Σ

*) Changement de tarif seulement avec un entrée digital (option module d'extension)

Calcul des grandeurs mesurées: Le calcul des grandeurs mesurées se fait en accord avec DIN 40 110, à l'exception de la puissance réactive. Le SINEAX A 210/A 220 calcule celle-ci en tenant compte du signe.

Des convertisseurs de mesure resp. des indicateurs peuvent donc éventuellement afficher des valeurs différentes pour la puissance réactive. La raison à ceci est à chercher dans les différentes méthodes de calcul.

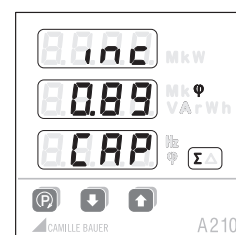

Système

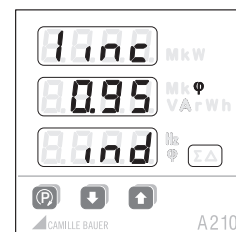

Phase 1

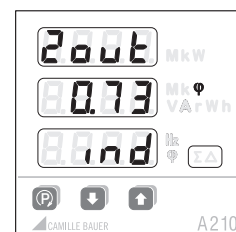

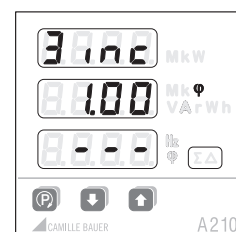

Phase 2





Phase 3

Niveaux d'affichage



En dedans d'un niveau (1, 2, 3, ...), vous pouvez commuter les 3 affichages au mode suivant (a, b, c, ...) en appuyant sur la touche . Au bout du mode, l'affichage recommence automatiquement au mode a.

En appuyant brièvement sur l'une des touches  ou , vous pouvez passer au niveau suivant.



4 fils à charges déséquilibrées

								
		a	b	c	d	e	f	
 	1	U1 U2 U3	U1 _{max.} U2 _{max.} U3 _{max.}	U1 _{min.} U2 _{min.} U3 _{min.}	U12 U23 U31	U12 _{max.} U23 _{max.} U31 _{max.}	U12 _{min.} U23 _{min.} U31 _{min.}	
	2	I1 I2 I3	I1 _{max.} I2 _{max.} I3 _{max.}	I1 _{avg.} I2 _{avg.} I3 _{avg.}	I1 _{avgmax.} I2 _{avgmax.} I3 _{avgmax.}	IN	IN _{max.}	
	3	P1 P2 P3	P1 _{max.} P2 _{max.} P3 _{max.}	P	P _{max.}			
	4	Q1 Q2 Q3	Q1 _{max.} Q2 _{max.} Q3 _{max.}	Q	Q _{max.}			
	5	S1 S2 S3	S1 _{max.} S2 _{max.} S3 _{max.}	S	S _{max.}			
	6	PF1	PF2	PF3	PF	PF _{minind}	PF _{mincap}	
	7	F						
	8	EP inc HT ¹	EP inc LT ²	EP out HT ¹	EP out LT ²			
	9	EQ ind HT ¹	EQ ind LT ²	EQ cap HT ¹	EQ cap LT ²			
	10	P Q PF	P S F					
	11	Pint0	Pint1	Pint2	Pint3	Pint4		
	12	Qint0	Qint1	Qint2	Qint3	Qint4		
	13	Sint0	Sint1	Sint2	Sint3	Sint4		

3 fils à charges déséquilibrées



						
		a	b	c	d	e
 	1	U12 U23 U31	U12 _{max.} U23 _{max.} U31 _{max.}	U12 _{min.} U23 _{min.} U31 _{min.}		
	2	I1 I2 I3	I1 _{max.} I2 _{max.} I3 _{max.}	I1 _{avg.} I2 _{avg.} I3 _{avg.}	I1 _{avgmax.} I2 _{avgmax.} I3 _{avgmax.}	
	3	P	P _{max.}			
	4	Q	Q _{max.}			
	5	S	S _{max.}			
	6	PF	PF _{minind}	PF _{mincap}		
	7	F				
	8	EP inc HT ¹	EP inc LT ²	EP out HT ¹	EP out LT ²	
	9	EQ ind HT ¹	EQ ind LT ²	EQ cap HT ¹	EQ cap LT ²	
	10	P Q PF	P S F			
	11	Pint0	Pint1	Pint2	Pint3	Pint4
	12	Qint0	Qint1	Qint2	Qint3	Qint4
	13	Sint0	Sint1	Sint2	Sint3	Sint4

Monophasé, 3 fils à charges équilibrées, 4 fils à charges équilibrées



						
		a	b	c	d	e
 	1	U	U _{max.}	U _{min.}		
	2	I	I _{max.}	I _{avg.}	I _{avgmax.}	
	3	P	P _{max.}			
	4	Q	Q _{max.}			
	5	S	S _{max.}			
	6	PF	PF _{minind}	PF _{mincap}		
	7	F				
	8	EP inc HT ¹	EP inc NT ²	EP out HT ¹	EP out NT ²	
	9	EQ ind HT ¹	EQ ind NT ²	EQ cap HT ¹	EQ cap NT ²	
	10	P Q PF	P S F			
	11	Pint0	Pint1	Pint2	Pint3	Pint4
	12	Qint0	Qint1	Qint2	Qint3	Qint4
	13	Sint0	Sint1	Sint2	Sint3	Sint4

Utilisation

Luminosité

13 gradins: appuyer longuement sur les touches  (plus foncé) ou  (plus clair).

Effacer / Clear

En appuyant simultanément sur les touches   les valeurs min. et max. resp. les valeurs d'énergie sont effacées.

Blocage

La remise à zéro des compteurs d'énergie peut être bloquée en plaçant le pontet respectif à l'arrière de l'appareil en position LOCK.

¹ HT = Tarif normal

² LT = Tarif réduit

Programmation

Tous les paramètres peuvent à chaque instant être affichés. Pour des modifications, il faut toutefois retirer le pontet placé au dos de l'appareil (position pas sur LOCK).



Le tableau suivant indique tous les paramètres avec la gamme des étendues resp. les sélections possibles. Les numéros en noir renvoient au point respectif des diagrammes de la page 30.

En appuyant longuement sur la touche  on passe de l'affichage au niveau Menu.

Le point désiré du menu s'atteint en appuyant brièvement la touche .

Par la touche  on arrive au niveau paramètres qui permet l'affichage des paramètres désirés.

En appuyant brièvement la touche , l'élément désiré commence à clignoter.

La valeur qui clignote peut être modifiée par les touches  / .

En appuyant longuement la touche  il est possible de sortir des niveaux Menu et Paramètres.

Les valeurs programmées restent mémorisées en cas de manque de tension d'alimentation.

Informations importantes:

Le genre de raccordement et les rapports des transformateurs de mesure doivent toujours être introduites en premier, étant donnée que les affichages des valeurs mesurées, des valeurs limites etc., en dépendent.

La programmation peut également être modifiée par le module d'extension (en option).

Blocage de la programmation

Pontet dans la position LOCK.

La programmation de toutes les valeurs est bloquée.

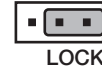























LOCK

Réglage en usine

Luminosité:	(valeur moyenne)
Valeur limite/S01:	Off
Valeur limite/S02:	Off
Rapport des transformateurs de mesure:	1 : 1
Pontet:	pas dans la position LOCK
Possibilités de raccordement:	4 fils déséquilibrées
Intervalle synchrone:	15 min.

Aperçu des paramètres

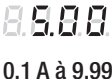



No.	Affichage en haut Affichage au centre	Affichage en bas (Sélection, * = Default)	Signification	Information
1	 		Possibilités de raccordement	
			4 fils à charges déséquilibrées	(4 lines unbalanced)
			3 fils à charges déséquilibrées	(3 lines unbalanced)
			4 fils à charges équilibrées	(4 lines balanced)
			3 fils à charges équilibrées	(3 lines balanced)
			Monophasé	(1 line)
2	 		Nature de charge pour récupération d'énergie: Mathématique	Affichage 4 quadrants Ind-Cap-Ind-Cap
			Nature de charge pour récupération d'énergie: Electrique	Affichage 4 quadrants Ind-Ind-Cap-Cap
3	 	 100 V à 999 kV	Tension primaire du transformateur de mesure sur l'entrée tension (tension entre phases)	D'abord introduire un chiffre quelconque à 3 chiffres et l'unité et ensuite par pas avec le facteur 10
4	 	 100 V à 999 V	Tension secondaire du transformateur de mesure sur l'entrée tension (tension entre phases)	
5	 	 1,00 A à 999 kA	Courant primaire du transformateur de mesure sur l'entrée courant	
6	 	 0,1 A à 9,99 A	Courant secondaire du transformateur de mesure sur l'entrée courant	

No.	Affichage en haut Affichage au centre	Affichage en bas (Sélection, * = défaut)	Signification	Information		
7	8888 / .2 8888		Mode de fonctionnement des deux sorties numériques «out.1» et «out.2»	(mode)		
		8888 *	Sortie déclenchée	La sélection de l'interface bus est toutefois possible		
		8888	Sortie d'impulsions énergie	La sortie produit des impulsions d'énergie à la cadence ajustée sous 12 . La valeur du chiffre de sortie est sélectionnée sous 11 .		
		8888	Sortie alarme	Lors du dépassement de la valeur limite 9 , la sortie est activée (le courant passe) resp. passive pour la sortie au dessous de la valeur 10 . Le choix de la grandeur à surveiller se réalise par 8 .		
8	8888 / .2 8888		Grandeur avec alarme	Ce choix est proposé si le mode de fonctionnement 7 a préalablement été mis sur ALM		
				Line Type		
				'1L', '3Lb', '4Lb'	'3Lu'	'4Lu'
		8888	Fréquence	●	●	●
		8888	Courant du neutre			●
		8888	Intervalle puissance apparente	●	●	●
		8888	Intervalle puissance réactive	●	●	●
		8888	Intervalle puissance active	●	●	●
		8888	Facteur de puissance (cos φ)	●	●	○
		8888	Puissance apparente	●	●	○
		8888	Puissance réactive	●	●	○
		8888	Puissance active	●	●	○
		8888	Tension	●		
		8888 *	Tension de phase			○
		8888	Tension entre phases		○	○
8888	Courant de phase moyen (bimétal)	●	○	○		
8888	Courant de phase	●	○	○		
			○: 'A.on'= Condition OR des grand. de phase 'A.off'= Condition AND des grand. de phase			
9	8888 / .2 8888	8.200 v*	Limite d'enclenchement de l'alarme	La valeur maximum dépend de l'étendue de mesure possible, des rapports des transformateurs de mesure et du genre de raccordement.		
10	8888 / .2 8888	8.220 v*	Limite de déclenchement de l'alarme			

No.	Affichage en haut Affichage au centre	Affichage en bas (Sélection, * = défaut)	Signification	Information
■	0000 / .0 E.5000		Source du compteur d'énergie à impulsions	
		0000	Energie réactive capacitive tarif réduit	
		0000	Energie réactive capacitive tarif normal	
		0000	Energie réactive inductive tarif réduit	
		0000	Energie réactive inductive tarif normal	
		0000	Energie active fournie tarif réduit	(outgoing low tariff)
		0000	Energie active fournie tarif normal	(outgoing high tariff)
		0000	Energie active reçue tarif réduit	(incoming low tariff)
		0000 *	Energie active reçue tarif normal	(incoming high tariff)
■	0000 / .0 E.0000	0000 Mk* Wh 1 à 5000 / Wh à GWh	Nombre d'impulsions par unité d'énergie. Après sélection d'un chiffres entre 1 à 5000, il est possible d'introduire la valeur de base (-), Kilo (k), Mega (M) et Giga (Mk)	(energy rate)
■	5900 E.0000	0005 * 1 à 60 min.	Intervalle en minutes pour le calcul de la puissance à intervalles 0 = Intervalle piloté par bus	En cas de synchronisation externe, la valeur affichée est insignifiante.



Exemples

Exemple 1: Programmation de la possibilité de raccordement (3 fils à charges déséquilibrées)

- Appuyer la touche **[P]** > 2 s

- Appuyer la touche **[↓]** (indique l'ajustage actuel)

- Appuyer la touche **[P]** (la grandeur qui peut être programmée clignote)

- Appuyer la touche **[↓]** / **[↑]** (sélectionner le paramètre désiré)

- Appuyer la touche **[P]** (introduire la programmation). L'affichage ne clignote plus.

- Appuyer la touche **[P]** > 2 s (retour au niveau d'affichage)

Exemple 2: Programmation du rapport des transformateurs de mesure de tension et de l'intervalle de la mesure d'énergie













- Appuyer la touche **[P]** > 2 s

- Appuyer la touche **[P]** (menu rapports des transformateurs)

3. Appuyer la touche  (ajustage actuel de la tension primaire)





4. Appuyer la touche  (le chiffre à gauche clignote)



5. Appuyer les touches  ou  jusqu'à apparition du chiffre désiré
6. Appuyer la touche  (le chiffre du milieu clignote)
7. Appuyer les touches  ou  jusqu'à apparition du chiffre désiré
8. Appuyer la touche  (le chiffre à droite clignote)
9. Appuyer les touches  ou  jusqu'à apparition du chiffre désiré
10. Appuyer la touche  (le point décimal clignote)
11. Appuyer les touches  ou  jusqu'à ce que le point décimal soit au bon endroit et que les symboles Kilo/Mega désirés soient placés
12. Appuyer la touche  (introduire la programmation). L'affichage ne clignote plus.
13. Appuyer la touche  (ajustage actuel de la tension secondaire)



14. Programmation comme pour la tension primaire (point 1 à 12)
15. Appuyer la touche  jusqu'à apparition de l'affichage 

16. Appuyer 3 fois la touche 









17. Appuyer la touche  (affichage actuel en minutes)



18. Appuyer la touche  (le chiffre à gauche clignote)



19. Appuyer les touches  ou  jusqu'à apparition du chiffre désiré
20. Appuyer la touche  (le chiffres à droite clignote)
21. Appuyer les touches  ou  jusqu'à apparition du chiffre désiré
22. Appuyer la touche  (introduire la programmation). L'affichage ne clignote plus.
23. Appuyer la touche  > 2 s (retour au niveau d'affichage)

Brief description

The A 210/A 220 are panel mounting instruments for monitoring AC systems with dimensions 96 x 96 mm (A 210) and 144 x 144 mm (A 220). The following measurements are acquired: voltages, currents, frequency, and phase angles in single phase or 3 phase systems. From these, the active power, reactive power, apparent power, active energy, reactive energy, and the power factor and the neutral current can be calculated. With the use of voltage and current transformers, the instrument can be used for measurements in medium and high voltage systems. The transformation ratios are configurable for the direct display of all measurements. The A 210/A 220 instrument is used as a display with two S0 pulse or limit value outputs.

Technical data

(for more detailed information please see data sheet, download under www.camillebauer.com)

Measuring inputs

Nominal frequency:	50, 60 Hz
Nominal input voltage:	Phase-phase: 500 V Phase - N: 290 V
Nominal input current:	5 A or 1 A

Continuous overload withstand

10 A at 346 V single phase AC system
10 A at 600 V three phase system

Short duration overload withstand

Input variable	Number of applications	Duration of overload	Interval between two overloads
577 V LN	10	1 s	10 s
100 A	10	1 s	100 s
100 A	5	3 s	5 min

Measuring ranges

U, I, S:	≤ 120% of nominal value
P, Q:	≤ ± 120% of nominal value
F:	45 to 65 Hz
cosφ:	± 1

Pulse/Limit value outputs

Depending on the function selected, the two digital outputs can be used either as pulse outputs for active and reactive energy or as limit signals.

The outputs are passive, and are galvanically isolated from all the other circuits by opto-couplers. They are suitable to drive tariff devices (S0-standard DIN 43 864) or 24 V-relais.

U_{ext}	≤ 40 V DC (OFF: leakage current ≤ 0.1 mA)
I_L	≤ 150 mA (ON: terminal voltage ≤ 1.2 V)

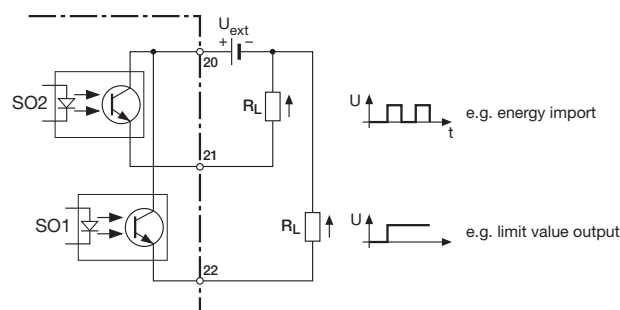

Limit value outputs

Any measured value can be allocated to the limit values.

Impulse outputs

Active and reactive energy impulses can be generated for driving electronic and electromechanical energy meters.

Power supply

DC, AC power pack 50 to 400 Hz
100 to 230 V AC/DC ±15% or 24 to 60 V AC/DC ±15%
(UL) 85 to 125 V DC
Power input: 3 VA (without extension module)



A marked and easily accessible current limiting switch has to be arranged in the vicinity of the device for turning off the power supply. Fusing should be 10 Amps or less and must be rated for the available voltage and fault current.

Reference conditions acc. to IEC 688 resp. EN 60 688

Sine 50 - 60 Hz, 15 - 30°, application group II

Measurement accuracy (related to nominal value)

Current, voltage	± 0.5%
Power	± 1.0%
Power factor	± 1.0%
Energy	± 1.0%
Frequency	± 0.02 Hz (abs.)

Environmental conditions

Operating temperature:	-10 to +55 °C
Storage temperature:	-25 to +70 °C
Relative humidity:	≤ 75%
Altitude:	2000 m max.
Indoor use statement	

Safety

Protection class:	II (voltage inputs with protection impedances)
Measuring category:	III
Pollution degree:	2
Measurement voltage:	300 V
Test voltage:	Between current inputs, power supply, digital outputs, terminals of the plugged-in module: 3700 V / 50 Hz / 1 min. At voltage inputs: 4.25 kV 1.2/50 μs
Module connections:	The pin rail at the back is connected to the voltage inputs via a protection impedance. Only the permitted modules can be plugged-in!
Enclosure protection:	IP 20

Note of maintenance

No maintenance is required.

Display

The measurement display is 3 digit resp. 4 digit (frequency) and right justified, with the exception of the energy values which are 8 digits. The left-hand 7-segment display is for the sign or an abbreviation.

Abbreviations:

	Maximal value
	Minimal value
	Average value
	Max. average value
	Minimal value for power factor; the worst out of the 3 values of P1, P2, or P3 is displayed
	Neutral current
	Inductive
	Capacitive
	Incoming
	Outgoing
	Interval active power
	Interval reactive power
	Interval apparent power

- Last interval; t-0
- Previous interval; t-1, -2, -3, -4
- Overload, out of range indicator
- Σ System value
- Δ Delta voltage

Energy meter

- High tariff
- Low tariff

	Interval 0	Interval 1	Interval 2	Interval 3	Interval 4
Current time t	t-0	t-1	t-2	t-3	t-4

Zero value suppression

PF resp. $\cos\varphi$: Display ---, if $S_x < 0.2\% S_{nenn}$
 Currents: Display 0, if $I_x < 0.1\% I_{nenn}$

Commissioning

The multi-functional power monitor is made operational by switching on the power supply. The following appears sequentially on the display:

1. **Segment tests:** all the segments of the displays and all the LEDs are lit for 2 s.
2. **Version of the software:** e.g. A 210 1.04
3. The 3 **line voltages** at switching on.

Loss of the power supply

All the values configured remain during a loss of the power supply. On reconnecting the power supply, the last **mode** selected is displayed.

Electrical connections



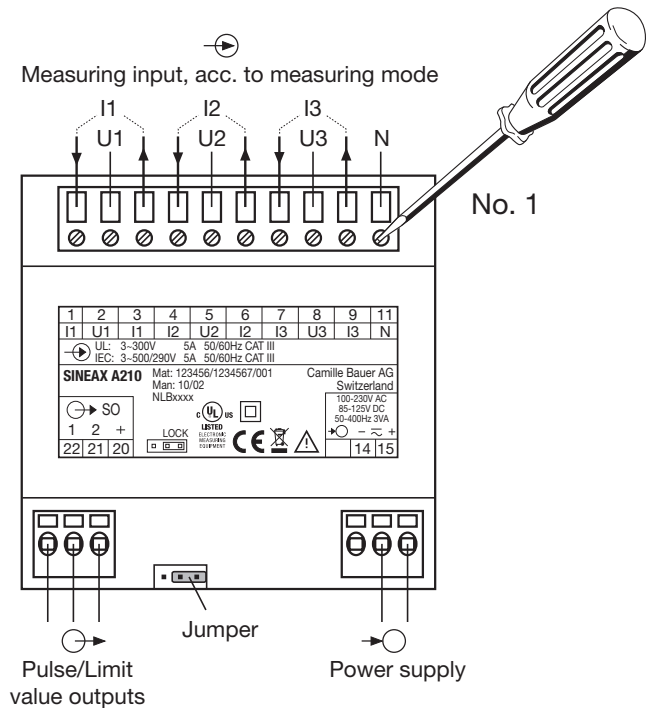

	<p>Safety Disconnects</p> <p>The mains supply power to the instrument must be installed downstream from a switched current limiting device. The circuit protection device should be 20 Amps or less, and must be rated for the available voltage and fault current; 5 Amp fuses are preferred.</p>
	<p>WARNING</p> <p>All mains supply power to the instrument must be installed downstream from a switched current limiting device. The circuit protection device should be 20 Amps or less, and must be rated for the available voltage and fault current; 5 Amps are preferred.</p>
	<p>The national provisions (e.g. in Germany VDE 0100 "Conditions concerning the erection of heavy current facilities with rated voltages below 1000 V") have to be observed in the installation and material selection of electric lines!</p>
	<p>When using external PT's or CT's refer to the manufacturer's information for connections for voltage and current monitoring.</p>



The electrical connections are identical for the SINEAX A 210 and A 220.

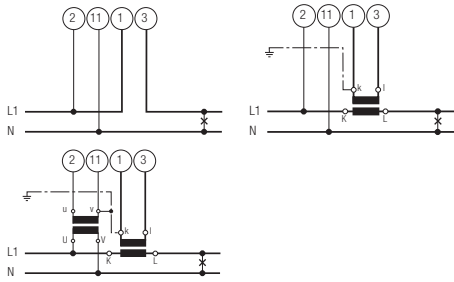

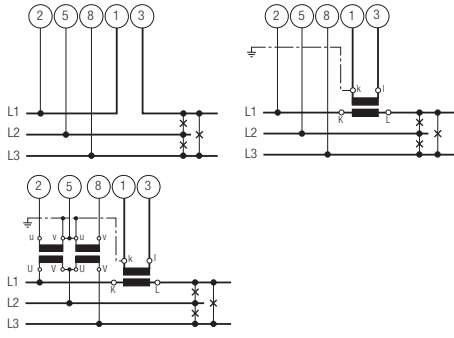
Symbol	Meaning
	Device may only be disposed of in a professional manner!
	Double insulation, device of protection class 2
	CE conformity mark. The device fulfills the requirements of the applicable EC directives.
	Products with this mark comply with both the Canadian (CSA) and the American (UL) requirements
	Caution! General hazard point. Read the operating instructions.
	General symbol: Input
	General symbol: Output
	General symbol: Power supply
CAT III	Measurement category CAT III for current and voltage inputs

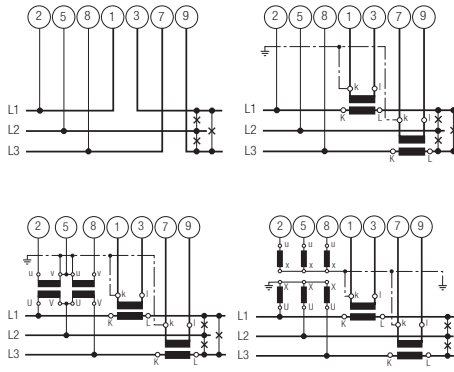
Connecting modes

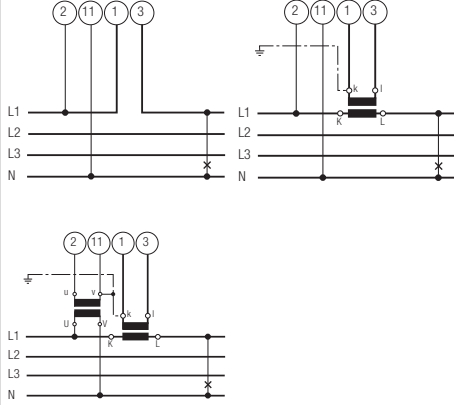
System/ application	Terminals																	
Single phase AC system 																		
3wire 3 phase symmetric load I: L1 	 <p>Connect the voltage according to the following table for current measurement in L2 or L3:</p> <table border="1"> <thead> <tr> <th>Current transf.</th> <th>Terminals</th> <th>2</th> <th>5</th> <th>8</th> </tr> </thead> <tbody> <tr> <td>L2</td> <td>1</td> <td>3</td> <td>L2</td> <td>L3</td> <td>L1</td> </tr> <tr> <td>L3</td> <td>1</td> <td>3</td> <td>L3</td> <td>L1</td> <td>L2</td> </tr> </tbody> </table>	Current transf.	Terminals	2	5	8	L2	1	3	L2	L3	L1	L3	1	3	L3	L1	L2
Current transf.	Terminals	2	5	8														
L2	1	3	L2	L3	L1													
L3	1	3	L3	L1	L2													
3 wire 3 phase asymmetric load 																		

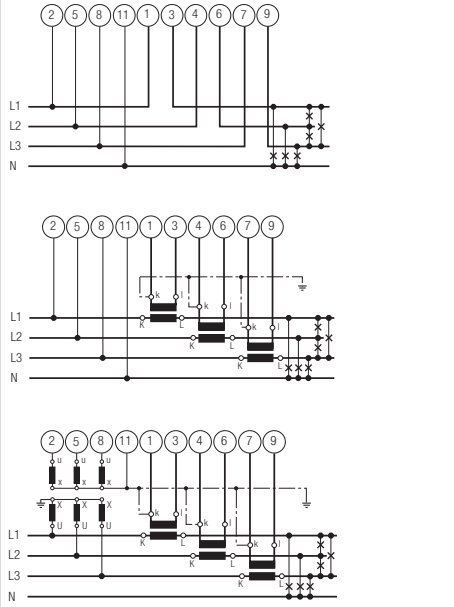
System/ application	Terminals														
4 wire 3 phase symmetric load I: L1 	 <p>Connect the voltage according to the following table for current measurement in L2 or L3:</p> <table border="1"> <thead> <tr> <th>Current trans.</th> <th>Terminals</th> <th>2</th> <th>11</th> </tr> </thead> <tbody> <tr> <td>L2</td> <td>1</td> <td>3</td> <td>L2</td> <td>N</td> </tr> <tr> <td>L3</td> <td>1</td> <td>3</td> <td>L3</td> <td>N</td> </tr> </tbody> </table>	Current trans.	Terminals	2	11	L2	1	3	L2	N	L3	1	3	L3	N
Current trans.	Terminals	2	11												
L2	1	3	L2	N											
L3	1	3	L3	N											
4 wire 3 phase asymmetric load 	 <p>3 single-pole insulated voltage transformers in high-voltage system</p>														

Display and operating

Display and operating are identical for the SINEAX A 210 and A 220

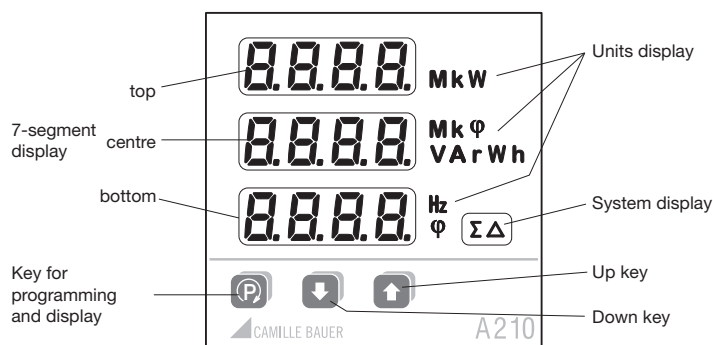

Available measurement data	Example display top	Example display centre	Example display bottom	Units display	System display
Phase voltages U1, U2, U3	230	231	229	V	
Maximum value U1 _{max.} , U2 _{max.} , U3 _{max.}	235	236	231	V	
Minimum value U1 _{min.} , U2 _{min.} , U3 _{min.}	227	226	225	V	
Delta voltages U12, U23, U31	400	402	398	V	Δ
Maximum values U12 _{max.} , U23 _{max.} , U31 _{max.}	405	406	403	V	Δ
Minimum values U12 _{min.} , U23 _{min.} , U31 _{min.}	395	397	396	V	Δ
Phase current I1, I2, I3	2.35	2.37	2.34	A	
Maximum values I1 _{max.} , I2 _{max.} , I3 _{max.}	2.39	2.40	2.38	A	
Average values I1 _{avg.} , I2 _{avg.} , I3 _{avg.} (bimetal -15 min.)	2.04	2.05	2.07	A	
Max. average values I1 _{avgmax.} , I2 _{avgmax.} , I3 _{avgmax.} (slave pointer-15 min.)	2.07	2.05	2.04	A	
Neutral current IN	0.0	0.45		A	
Active powers P1, P2, P3	56.1	56.2	56.5	kW	
Maximum values P1 _{max.} , P2 _{max.} , P3 _{max.}	60.5	60.4	60.3	kW	
Active power system P		125		kW	Σ
Maximum value P _{max.}		239		kW	Σ
Reactive power Q1, Q2, Q3	1.24	1.23	1.22	VAr	
Maximum values Q1 _{max.} , Q2 _{max.} , Q3 _{max.}	1.51	1.52	1.54	VAr	
Reactive power system Q		1.54		VAr	Σ
Maximum value Q _{max.}		2.31		VAr	Σ
Apparent power S1, S2, S3	2.56	2.58	2.60	VA	
Maximum values S1 _{max.} , S2 _{max.} , S3 _{max.}	3.43	3.44	3.67	VA	
Apparent power system S		5.33		VA	
Maximum value S _{max.}		6.23		VA	Σ
Power factor PF1, cosφ	0.87	0.87	0.87	φ	
Power factor PF2, cosφ	0.88	0.88	0.88	φ	
Power factor PF3, cosφ	0.89	0.89	0.89	φ	
Power factor system PF, cosφ	0.88	0.88	0.88	φ	Σ
Minimum value power factor inductive	0.76	0.76	0.76	φ	Σ
Minimum value power factor capacitive	0.84	0.84	0.84	φ	Σ
Frequency, F			49.99	Hz	
Active energy incoming EP high tariff	4589	2356	0.0000	kWh	Σ
Active energy incoming EP low tariff *)	1234	5678	0.0000	kWh	Σ
Active energy outgoing EP high tariff	4589	2356	0.0000	kWh	Σ
Active energy outgoing EP low tariff *)	1234	5678	0.0000	kWh	Σ
Reactive energy inductive EQ high tariff	9876	5432	0.0000	kVarh	Σ
Reactive energy inductive EQ low tariff *)	1234	9876	0.0000	kVarh	Σ
Reactive energy capacitive EQ high tariff	9876	5432	0.0000	kVarh	Σ
Reactive energy capacitive EQ low tariff *)	1234	9876	0.0000	kVarh	Σ
5 active power intervals Pint0, Pint1, ...	234	234	0.0	kW	Σ
5 reactive power intervals Quint0, Quint1, ...	123	123	0.0	VAr	Σ
5 apparent power intervals Sint0, Sint1, ...	10.1	10.1	0.0	VA	Σ

*) Tariff switching via digital input only (optional extension module required)

Determination of measured quantities: The calculation of the measurements is made in accordance with DIN 40 110, with the exception of the reactive power. This is calculated by the SINEAX A 210/A 220 as a signed value.

Transducers and displays can possibly display different values for the reactive power in the same power system. The reason is the different calculation methods.

Power factor cosφ 4 quadrant operation

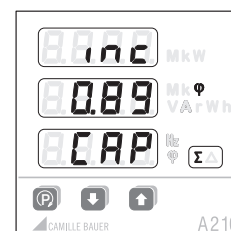

System

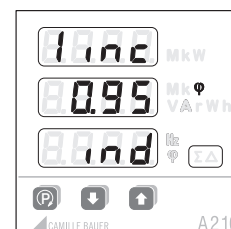

Phase 1

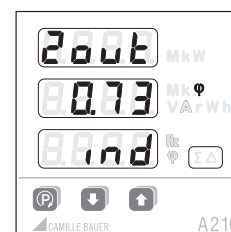

Phase 2

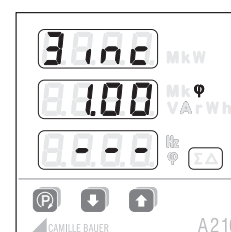

Phase 3

Display levels

Within a level (1, 2, 3 ...) you can change the 3 displays to the next mode (a, b, c, ...) with the **(P)** key. From the last mode, the display changes to mode a again.

Change to the next level with the **(↑)** and **(↓)** keys.

4 wire asymmetric load

		a	b	c	d	e	f	
 	1	U1 U2 U3	U1 _{max.} U2 _{max.} U3 _{max.}	U1 _{min.} U2 _{min.} U3 _{min.}	U12 U23 U31	U12 _{max.} U23 _{max.} U31 _{max.}	U12 _{min.} U23 _{min.} U31 _{min.}	
	2	I1 I2 I3	I1 _{max.} I2 _{max.} I3 _{max.}	I1 _{avg.} I2 _{avg.} I3 _{avg.}	I1 _{avgmax.} I2 _{avgmax.} I3 _{avgmax.}	IN	IN _{max.}	
	3	P1 P2 P3	P1 _{max.} P2 _{max.} P3 _{max.}	P	P _{max.}			
	4	Q1 Q2 Q3	Q1 _{max.} Q2 _{max.} Q3 _{max.}	Q	Q _{max.}			
	5	S1 S2 S3	S1 _{max.} S2 _{max.} S3 _{max.}	S	S _{max.}			
	6	PF1 PF2 PF3	PF1 _{minind.} PF2 _{minind.} PF3 _{minind.}	PF	PF _{minind.}	PF _{minicap.}		
	7	F						
	8	EP inc HT ¹	EP inc LT ²	EP out HT ¹	EP out LT ²			
	9	EQ ind HT ¹	EQ ind LT ²	EQ cap HT ¹	EQ cap LT ²			
	10	P Q PF	P S F					
	11	Pint0	Pint1	Pint2	Pint3	Pint4		
	12	Qint0	Qint1	Qint2	Qint3	Qint4		
	13	Sint0	Sint1	Sint2	Sint3	Sint4		

Single-phase, 3 wire symmetric load, 4 wire symmetric load

		a	b	c	d	e
 	1	U	U _{max.}	U _{min.}		
	2	I	I _{max.}	I _{avg.}	I _{avgmax.}	
	3	P	P _{max.}			
	4	Q	Q _{max.}			
	5	S	S _{max.}			
	6	PF	PF _{minind.}	PF _{minicap.}		
	7	F				
	8	EP inc HT ¹	EP inc NT ²	EP out HT ¹	EP out NT ²	
	9	EQ ind HT ¹	EQ ind NT ²	EQ cap HT ¹	EQ cap NT ²	
	10	P Q PF	P S F			
	11	Pint0	Pint1	Pint2	Pint3	Pint4
	12	Qint0	Qint1	Qint2	Qint3	Qint4
	13	Sint0	Sint1	Sint2	Sint3	Sint4

Operating

Brightness

13 levels: continuous pressing of the **(↓)** key (darker), or the **(↑)** key (brighter).

Delete / Clear

To delete the min. or max. values, or the energy values of the displayed measurements, press the **(↓)** **(↑)** keys at the same time.

Locking

The reset function for the energy meters can be locked by setting the jumper at the rear of the instrument to the position LOCK.

3 wire asymmetric load

		a	b	c	d	e
 	1	U12 U23 U31	U12 _{max.} U23 _{max.} U31 _{max.}	U12 _{min.} U23 _{min.} U31 _{min.}		
	2	I1 I2 I3	I1 _{max.} I2 _{max.} I3 _{max.}	I1 _{avg.} I2 _{avg.} I3 _{avg.}	I1 _{avgmax.} I2 _{avgmax.} I3 _{avgmax.}	
	3	P	P _{max.}			
	4	Q	Q _{max.}			
	5	S	S _{max.}			
	6	PF	PF _{minind.}	PF _{minicap.}		
	7	F				
	8	EP inc HT ¹	EP inc LT ²	EP out HT ¹	EP out LT ²	
	9	EQ ind HT ¹	EQ ind LT ²	EQ cap HT ¹	EQ cap LT ²	
	10	P Q PF	P S F			
	11	Pint0	Pint1	Pint2	Pint3	Pint4
	12	Qint0	Qint1	Qint2	Qint3	Qint4
	13	Sint0	Sint1	Sint2	Sint3	Sint4

¹ HT = high tariff

² LT = low tariff

Programming

All parameters may be displayed at any time. For modifications the jumper on the backside of the device must be removed (not on position LOCK).

The following table shows all parameters with their adjustable ranges or possible selections respectively. The black numbers give a cross-reference to the appropriate diagram position on page 30.

Starting at the measurands display by pressing the key **(P)** you may change to the menu level.

Afterwards you can select the desired menu item by pressing the key **(P)** shortly.

Use **(↓)** to enter the level where the desired parameter is displayed.

Pressing **(P)** shortly will force the selectable element to flash.

The flashing content may be modified using the keys **(↓)** or **(↑)**.

Press **(P)** for a longer time to leave the parameter or menu level.

All settings will remain non-volatile stored even in case of power-fail.

Hints:

First you have to set the system configuration and the transformer ratios because further measurand selections, alarm limit settings etc. will depend on them.

The programming may be modified via an optional extension module as well.

Locking the configuration

Place the jumper in the LOCK position.

The configuration of all parameters is disabled.



Factory Default

Brightness:	(mid setting)
Limit value / S01:	Off
Limit value / S02:	Off
Transformer ratio:	1 : 1
Jumper:	Not in the LOCK position
Connecting mode:	4 wire asymmetric load
Synchronizing interval:	15 min.

Parameters overview

No.	Topmost display Middle display	Undermost display (Selection, * = Default)	Meaning	Hints
1			System configuration	
		4000 *	4-line system, unbalanced load	(4 lines unbalanced)
		3000	3-line system, unbalanced load	(3 lines unbalanced)
		4000	4-line system, balanced load	(4 lines balanced)
		3000	3-line system, balanced load	(3 lines balanced)
		0000	Single-line system	(1 line)
2		0000	Load type for energy recovery: Mathematical	4 quadrant display, ind-cap-ind-cap
		0000	Load type for energy recovery: Electrical	4 quadrant display, ind-ind-cap-cap
3		0.500 kV [*] 100 V to 999 kV	Primary voltage of an external transformer on the voltage (line-to-line voltage)	First you enter any 3-digit number followed by the appropriate power unit selection in steps of factor 10
		0.500 v [*] 100 V to 999 V	Secondary voltage of an external transformer on the voltage input (line-to-line voltage)	
5		0.500 A [*] 1.00 A to 999 kA	Primary current of an external transformer on the current input	
		0.500 A [*] 0.1 A to 9,99 A	Secondary current of an external transformer on the current input	
6				

No.	Topmost display Middle display	Undermost display (Selection, * = default)	Meaning	Hints		
7	8888 / .2 8888		Operating mode of both digital outputs "out.1" and "out.2"	(mode)		
		8888 *	Output switched-off	Simulation via interface module is still possible		
		8888	Energy pulse output	The output generates energy pulses depending on the rate set under 12 . The meter measurands to output may be selected under 11 .		
		8888	Alarm output	If the alarm limit 9 is exceeded the output will be active (current flows). If the measurand is below limit 10 the output will be passive. The source of the monitored is selected under 8 .		
8	8888 / .2 8888		Alarm supervision source	This selection is presented only if operating mode 7 is set to ALM previously		
				Line Type		
				'1L', '3Lb', '4Lb'	'3Lu'	'4Lu'
		8888	Frequency	●	●	●
		8888	Neutral current			●
		5888	Apparent power interval	●	●	●
		9888	Reactive power interval	●	●	●
		8888	Active power interval	●	●	●
		8888	Power factor (cos φ)	●	●	○
		5888	Apparent power	●	●	○
		9888	Reactive power	●	●	○
		8888	Active power	●	●	○
		0888	Voltage	●		
		0888 *	Line-neutral voltage			○
		0888	Line-to-line voltage		○	○
8888	Average current (bimetal)	●	○	○		
8888	Phase current	●	○	○		
				○: 'A.on'= OR-operation of line-measurands 'A.off'= AND-operation of line-measurands		
9	8888 / .2 8888	8888 v*	Alarm limit for ON-state	The maximum values of the alarm limits depend on the possible measuring range (fixed by hardware), converted into possible primary values given by the selected system configuration and transformation ratios.		
10	8888 / .2 8888	8888 v*	Alarm limit for OFF-state			

No.	Topmost display Middle display	Undermost display (Selection, * = default)	Meaning	Hints
11			Source of energy meters for pulse output	
			Reactive energy capacitive, low tariff	
			Reactive energy capacitive, high tariff	
			Reactive energy inductive, low tariff	
			Reactive energy inductive, high tariff	
			Active energy outgoing, low tariff	(outgoing low tariff)
			Active energy outgoing, high tariff	(outgoing high tariff)
			Active energy incoming, low tariff	(incoming low tariff)
		*	Active energy incoming, high tariff	(incoming high tariff)
12		Mk * Wh 1 to 5000 / Wh to GWh	Number of pulses per displayed energy unit. After entering a number from 1 to 5000 you may input the scaling: Basic unit (-), kilo (k), Mega (M) or Giga (Mk)	(energy rate)
13		* 1 to 60 min.	Time interval in minutes for the calculation of power intervals 0 = Interval controlled via the bus	For external synchronization, the value displayed is not relevant

Examples

Example 1: Programming the system configuration
(3-line, unbalanced load)

- Press > 2 s
- Press (present setting is displayed)
- Press (alterable parameter flashes)
- Press / to select desired setting

- Press (takes over new setting).
Display stops flashing.
- Press > 2 s to return to display level

Example 2: Programming voltage transformer ratio and synchronization interval

- Press > 2 s
- Press (transformer ratio menu)

3. Press (present setting of primary voltage)



4. Press (leftmost digit flashes)



5. Press / until desired number appears
6. Press (middle digit flashes)
7. Press / until desired number appears
8. Press (rightmost digit flashes)
9. Press / until desired number appears
10. Press (decimal point flashes)
11. Press / until the decimal point is on the desired position and the kilo/Mega display is correct
12. Press (takes over new value).
The display stops flashing
13. Press (present setting of secondary voltage)



14. Programming procedure same as for primary voltage (1 to 12)
15. Press until the topmost display

 as shown

16. Press three times



17. Press (present setting of synchronization interval in minutes)



18. Press (left digit flashes)



19. Press / until desired number appears
20. Press (right digit flashes)
21. Press / until desired number appears
22. Press (takes over new value).
The display stops flashing
23. Press > 2 s (return to display level)

Konformitätserklärung / Certificat de conformité / Declaration of conformity













SINEAX A 210

 EG - KONFORMITÄTSERKLÄRUNG EC DECLARATION OF CONFORMITY		 CAMILLE BAUER
Dokument-Nr./ Document.No.:	A210_CE-konf.DOC	
Hersteller/ Manufacturer:	Camille Bauer AG Switzerland	
Anschrift / Address:	Aargauerstrasse 7 CH-5610 Wohlien	
Produktbezeichnung/ Product name:	Multifunktionales Leistungsmessgerät mit Bus-Interface Multifunctional Power Monitor with Bus-Interface	
Typ / Type:	SINEAX A 210 mit Bus-Interface	
Das bezeichnete Produkt stimmt mit den Vorschriften folgender Europäischer Richtlinien überein, nachgewiesen durch die Einhaltung folgender Normen:		
The above mentioned product has been manufactured according to the regulations of the following European directives proven through compliance with the following standards:		
Nr. / No.	Richtlinie / Directive	
2004/108/EG 2004/108/EC	Elektromagnetische Verträglichkeit - EMV-Richtlinie Electromagnetic compatibility - EMC directive	
EMV / EMC	Fachgrundnorm / Generic Standard	Messverfahren / Measurement methods
Störaussendung / Emission	EN 61000-6-4 : 2007	EN 55011 : 2007+A2:2007
Störfestigkeit / Immunity	EN 61000-6-2 : 2005	IEC 61000-4-2: 1995+A1:1998+A2:2001 IEC 61000-4-3: 2006+A1:2007 IEC 61000-4-4: 2004 IEC 61000-4-5: 2005 IEC 61000-4-6: 2008 IEC 61000-4-8: 1993+A1:2000 IEC 61000-4-11: 2004
Nr. / No.	Richtlinie / Directive	
2006/95/EG 2006/95/EC	Elektrische Betriebsmittel zur Verwendung innerhalb bestimmter Spannungsgrenzen – Niederspannungsrichtlinie – CE-Kennzeichnung : 95 Electrical equipment for use within certain voltage limits – Low Voltage Directive – Attachment of CE marking : 95	
EN/Norm/Standard	IEC/Norm/Standard	
EN 61010-1: 2001	IEC 61010-1: 2001	
Ort, Datum / Place, date:	Wohlien, 17. Februar 2009	
Unterschrift / signature:	 	
M. Ulrich Leiter Technik / Head of engineering	J. Brem Qualitätsmanager / Quality manager	

SINEAX A 220

 EG - KONFORMITÄTSERKLÄRUNG EC DECLARATION OF CONFORMITY		 CAMILLE BAUER
Dokument-Nr./ Document.No.:	A220_CE-konf.DOC	
Hersteller/ Manufacturer:	Camille Bauer AG Switzerland	
Anschrift / Address:	Aargauerstrasse 7 CH-5610 Wohlien	
Produktbezeichnung/ Product name:	Multifunktionales Leistungsmessgerät mit Bus-Interface Multifunctional Power Monitor with Bus-Interface	
Typ / Type:	SINEAX A 220 mit Bus-Interface	
Das bezeichnete Produkt stimmt mit den Vorschriften folgender Europäischer Richtlinien überein, nachgewiesen durch die Einhaltung folgender Normen:		
The above mentioned product has been manufactured according to the regulations of the following European directives proven through compliance with the following standards:		
Nr. / No.	Richtlinie / Directive	
2004/108/EG 2004/108/EC	Elektromagnetische Verträglichkeit - EMV-Richtlinie Electromagnetic compatibility - EMC directive	
EMV / EMC	Fachgrundnorm / Generic Standard	Messverfahren / Measurement methods
Störaussendung / Emission	EN 61000-6-4 : 2007	EN 55011 : 2007+A2:2007
Störfestigkeit / Immunity	EN 61000-6-2 : 2005	IEC 61000-4-2: 1995+A1:1998+A2:2001 IEC 61000-4-3: 2006+A1:2007 IEC 61000-4-4: 2004 IEC 61000-4-5: 2005 IEC 61000-4-6: 2008 IEC 61000-4-8: 1993+A1:2000 IEC 61000-4-11: 2004
Nr. / No.	Richtlinie / Directive	
2006/95/EG 2006/95/EC	Elektrische Betriebsmittel zur Verwendung innerhalb bestimmter Spannungsgrenzen – Niederspannungsrichtlinie – CE-Kennzeichnung : 95 Electrical equipment for use within certain voltage limits – Low Voltage Directive – Attachment of CE marking : 95	
EN/Norm/Standard	IEC/Norm/Standard	
EN 61010-1: 2001	IEC 61010-1: 2001	
Ort, Datum / Place, date:	Wohlien, 17. Februar 2009	
Unterschrift / signature:	 	
M. Ulrich Leiter Technik / Head of engineering	J. Brem Qualitätsmanager / Quality manager	









Kurzanleitung zum Ändern der Parameter



- In der Parameter-Ebene Taste  drücken
- Einstellbare 7-Segmentanzeige(n)  blinkt
- Mit Taste  oder  den blinkenden Inhalt einstellen.
Einstellbare Werte siehe Legende zu Diagramm ( bis ), abgebildet sind Default-Werte
- Taste  drücken.
Falls die nächste 7-Segmentanzeige,  der Dezimalpunkt oder eine Masseinheit  blinkt: Zurück zu Punkt 3.
- Mit Taste  oder  zum nächsten Parameter wechseln. Weiter mit Punkt 2.
oder
mit Taste  zurück in die Menü-Ebene. Weiter mit Punkt 1.

Rückkehr in die Messwert-Anzeige:

 -Taste länger als 2 Sekunden drücken













Instruction abrégée pour modifier les paramètres

- Au niveau paramètres appuyer la touche 
- L'affichage à 7 segments respectif clignote 
- Avec les touches  ou  ajuster les valeurs clignotantes, voir légende aux diagrammes ( à ), les valeurs en défaut sont illustrées
- Appuyer la touche  .
Si un autre affichage à 7 segments , ou un point décimal ou une unité de mesure  clignote retour au point 3.

- A l'aide des touches  ou  passer au paramètre suivant. Continuer avec point 2.
ou
par la touche  retourner au niveau Menu. Continuer avec point 1.

Retour à l'affichage des valeurs de mesure en appuyant la touche  pour plus de 2 secondes.

Brief operating instruction for parameter modification

- On the parameter level press key 
- Adjustable 7-segment display  flashes
- Use  or  to set the flashing content.
Adjustable values see  to  in the parameter overview. All values shown are default values
- Press key  .
If there is still a flashing 7-segment digit , decimal point or unit  : Back to 3.
- Change to the next parameter by pressing  or  and go back to 2.
or
go back to menu level with  and go on with 1.

Return to measurands display:

Press  for more than 2 seconds.

Anzeige-Ebene

Niveaux d'affichage

Display level

Menü-Ebene

Niveaux du menu

Menu level

Parameter-Ebene

Niveaux du paramètre

Parameter level

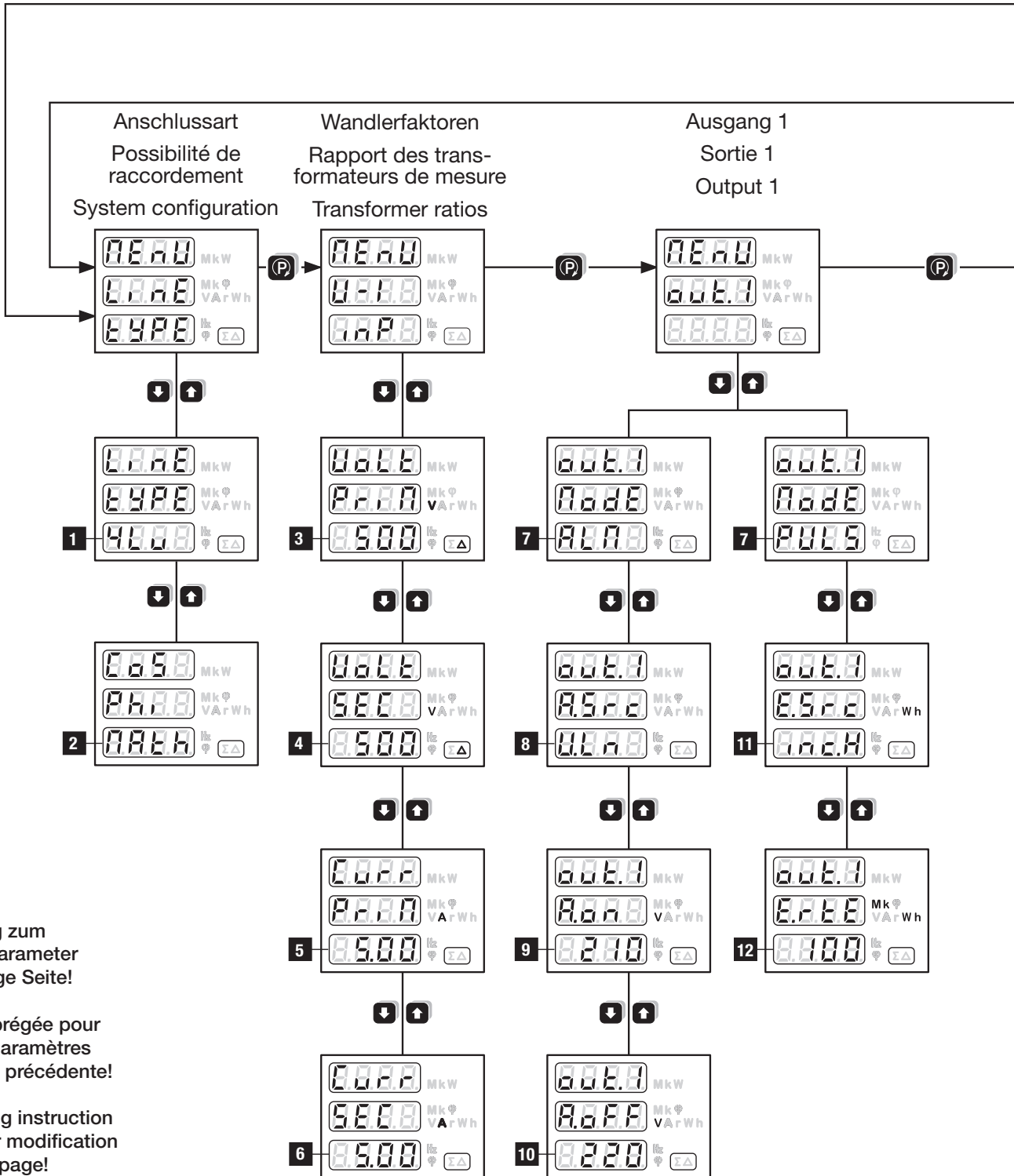

Kurzanleitung zum Ändern der Parameter siehe vorherige Seite!

Instruction abrégée pour modifier les paramètres voir à la page précédente!

Brief operating instruction for parameter modification see previous page!

Messwert-Anzeige
Affichage des valeurs de mesure
Measurands display

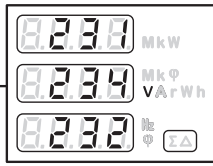

> 2s

> 2s

Zurück aus jeder Anzeige
Retour de chaque affichage
Back from any other display

Ausgang 2
Sortie 2
Output 2

Leistungs-Intervall
Intervalle de puissance
Power interval

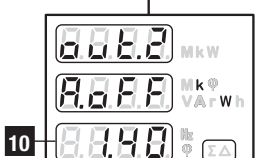
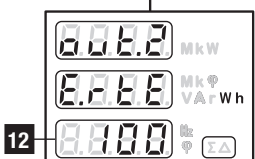
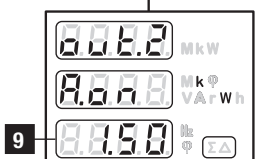
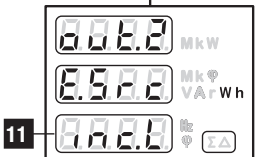
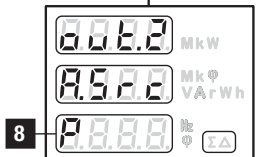
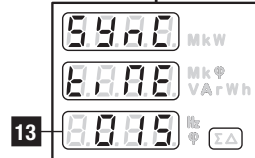
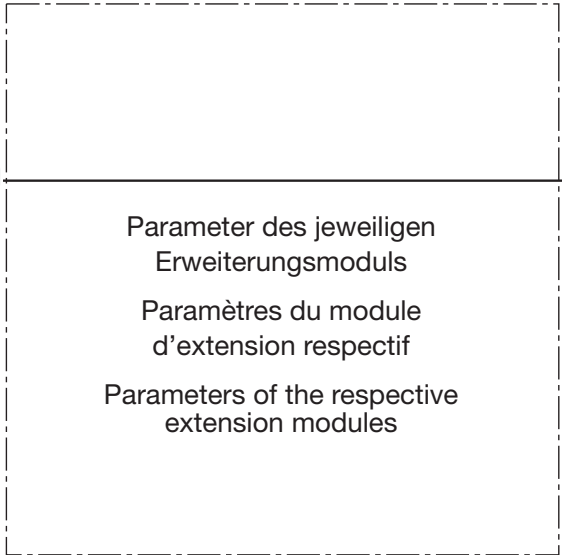
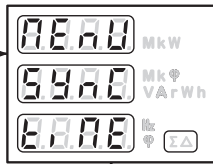
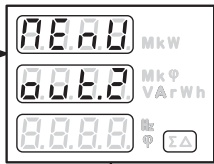

Masszeichnung / Croquis d'encombrement / Dimensional drawing SINEAX A 210

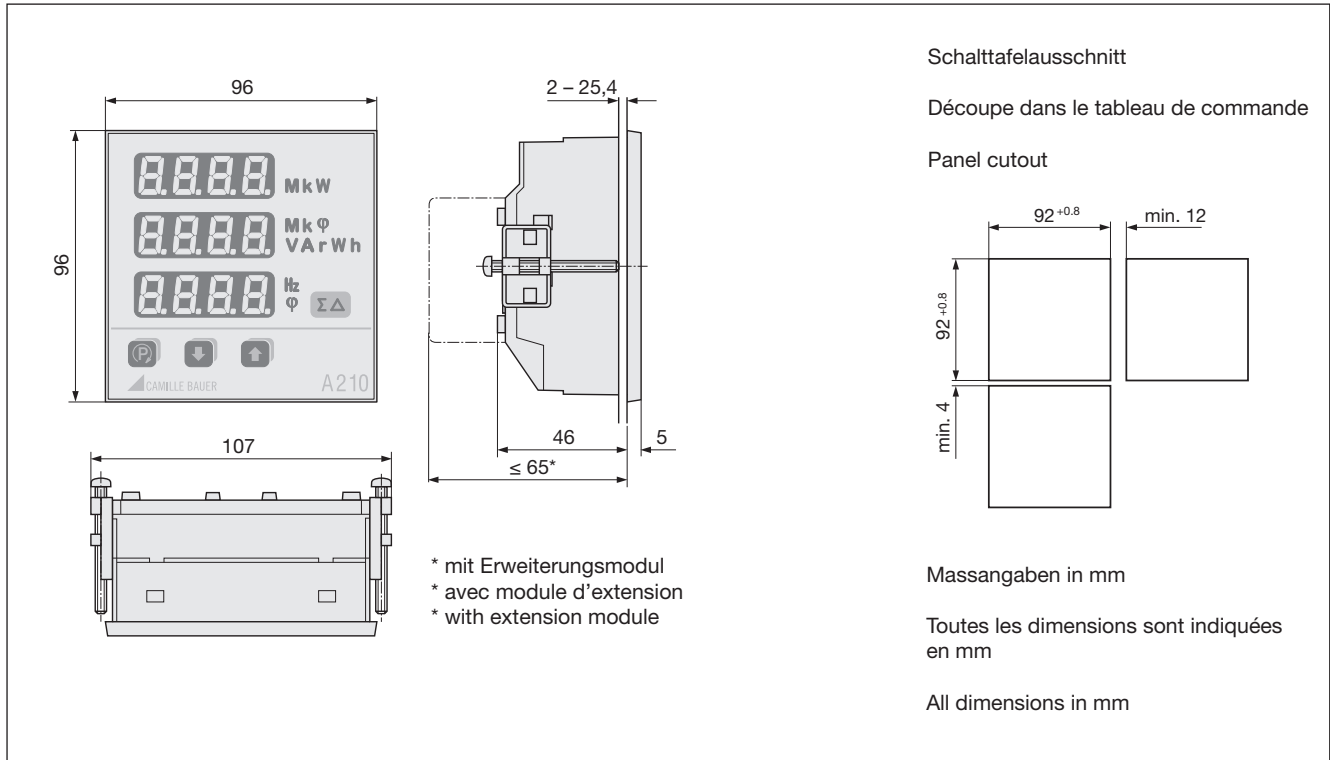

Masszeichnung / Croquis d'encombrement / Dimensional drawing SINEAX A 220

