

Safety precautions to be strictly observed are marked with following symbols in the operating instructions:



The instruments must only be disposed of in the correct way!

Operating Instructions

Passive DC signal isolator SINEAX TI 816



Camille Bauer LTD
Aargauerstrasse 7
CH-5610 Wohlen/Switzerland
Phone +41 56 618 21 11
Fax +41 56 618 35 35
e-mail: info@camillebauer.com
http://www.camillebauer.com



TI 816-5 Be 996 118-03 10.10

Contents

1. Read first and then ...	1
2. Scope of supply	1
3. Brief description	1
4. Versions	1
5. Technical data	1
6. Mounting	1
7. Electrical connections	2
8. Commissioning and maintenance	2
9. Releasing the signal isolator	2
10. Dimensional drawings	2
11. Declaration of conformity	2

1. Read first and then ...



The proper and safe operation of the device assumes that the operating instructions is **read carefully** and the safety warnings given in the various Sections

6. Mounting

7. Electrical connections

are **observed**.

The device should only be handled by appropriately trained personnel who are familiar with it and authorised to work in electrical installations.

Unauthorized repair or alteration of the unit invalidates the warranty!

2. Scope of supply

Signal isolator (Fig. 1)

1 ea. operating instructions (Fig. 2) in English, French, German



Fig. 1



Fig. 2

3. Brief description

The signal isolator SINEAX TI 816 serves to electrically insulate an analogue DC signal in the range 0...20 mA which depending on version is then converted to a current or voltage signal (0...20 mA or 0...10 V). It does **not** require a separate power supply.

The instrument fulfils all the important requirements and regulations concerning electromagnetic compatibility **EMC** and **Safety** (IEC 1010 resp. EN 61 010). It was developed and is manufactured and tested in strict accordance with the **quality assurance standard** ISO 9001.

4. Versions

There are two versions of the DC signal isolator SINEAX TI 816 available.

Description	Output signal A	Order code	Order No.
Passive DC signal isolator input signal E: 0...20 mA, with 1 isolation and transmission channel, in carrying rail housing N12	0...20 mA	816-5110	990 722
	0...10 V	816-5111	994 089

5. Technical data

Input signal E

DC current:	0...20 mA
Max. permissible current:	50 mA
Voltage limiter:	18 V ± 5% (with zener diode)
Voltage drop:	< 2.1 V (for 500 Ω burden)
Overshoot:	< 20 μA (typical 5 μA)

Output signal A

DC current or	0...20 mA or 0...10 V
DC voltage:	
Limit:	Approx. 30 mA ¹ Approx. 15 V ²
Max. burden:	600 Ω ¹
Internal resistance:	500 Ω ²
Residual ripple:	< 20 mV ss
Time constant:	Approx. 5 ms

Accuracy data

Error limits:	< ± 0,1% ¹ (reference value 20 mA, linearity error included)
	< ± 0,2% ² (reference value 10 V, linearity error included)

Ambient conditions

Operating temperature:	-20 to + 65 °C
Storage temperature:	-40 to + 85 °C
Annual mean relative humidity:	≤ 75% Standard climatic rating
Seismic test:	5 g, < 200 Hz, 2 h in each of 3 directions
Shock test:	50 g , 10 shocks in each of 3 directions
Altitude:	2000 m max.
Indoor use statement	

6. Mounting

The SINEAX TI 816 isolator is suitable for mounting on two different types of standard rails:

- onto the G-type rail EN 50 035-G32
or
- onto the top-hat rail EN 50 022-35 × 7.5.

¹ With current signal

² With voltage signal

 Note "**Ambient conditions**" in Section "5. Technical data" when determining the place of installation!

Simply clip the signal isolator onto the carrying rail acc. to Fig. 3 or Fig. 4.

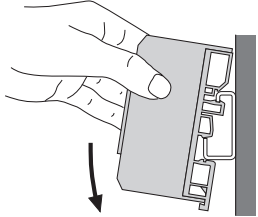

Fig. 3. Mounting onto the G-type rail.

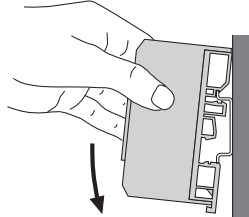

Fig. 4. Mounting onto the top-hat rail.

7. Electrical connections

Easily accessible screw terminals are provided at the front of the signal isolator (Fig. 6) which accept wire gauges up to 2.5 mm² (stranded wire) or 4 mm² (non-stranded wire).



Note that, ...

... the data required to perform the electrical insulation task agree with the data on the nameplate of the SINEAX TI 816 (→ input signal and → output signal, see Fig. 5)!

... in the case of isolators with **current** outputs 0...20 mA, the total resistance of the external leads (receiver plus leads) **does not** exceed the max. burden of **600 Ω**! See "output signal", section "5. Technical data"!

... in the case of isolators with a **voltage** output 0...10 V, the external receiver connected across the output has a sufficiently **high** internal resistance R_{IA} in relation to the SINEAX TI 816 output impedance of **500 Ω**! See "Output signal" in Section "5. Technical data"!

The error due to R_{IA} is:

$$F [\%] = \frac{500 [\Omega] \cdot 100}{R_{IA} [\Omega]}$$

... that input and output cables should be twisted pairs and run as far as possible away from heavy current cables!



Camille Bauer AG Aargauerstr. 7 CH-5610 Wohlen Switzerland	Typ 816 – 5110	 
	→ 0...20 mA → 0...20 mA	Art.: 990722 / 1234567 / 001

Fig. 5. Example of a nameplate.

Connect the input and output leads E and A according to Fig. 6.

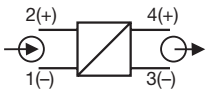

Fig. 6. Terminal allocation.

E = Input signal,
A = Output signal.

8. Commissioning and maintenance

The device is in operation as soon as the input signal E is connected.
The signal isolator requires no maintenance.

9. Releasing the signal isolator

When dismantling the SINEAX TI 816 ...

... from **G rails** proceed according to Fig. 7. Firstly press the signal isolator upwards (manipulation 1) and tip it upwards at the same time (manipulation 2).

... from **top-hat rails** proceed according to Fig. 8. Tip the signal isolator upwards.

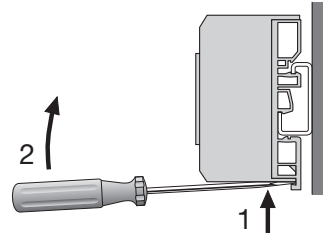

Fig. 7

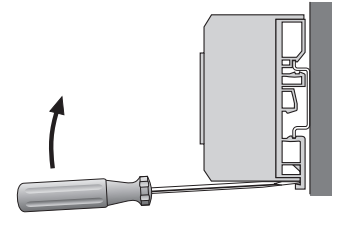

Fig. 8

10. Dimensional drawings

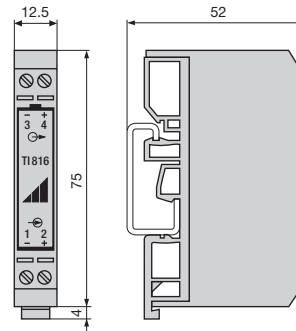

Fig. 9. SINEAX TI 816 on G-type rail
EN 50 035 – G 32.

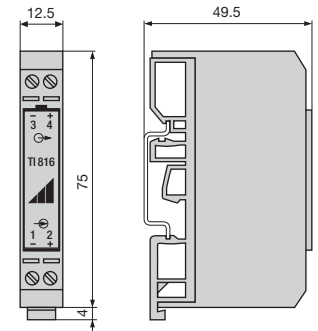

Fig. 10. SINEAX TI 816 on top-hat rail
EN 50 022 – 35×7.5.

11. Declaration of conformity



EG - KONFORMITÄTSERKLÄRUNG  **CAMILLE BAUER**
DECLARATION OF CONFORMITY

Dokument-Nr./ Document No.: TI816_CE-konf.DOC

Hersteller/ Manufacturer: Camille Bauer AG
Switzerland

Anschrift / Address: Aargauerstrasse 7
CH-5610 Wohlen

Produktbezeichnung/ Product name: Passiver DC- Signaltrenner
Passive DC signal isolator

Typ / Type: SINEAX TI 816

Das bezeichnete Produkt stimmt mit den Vorschriften folgender Europäischer Richtlinien überein, nachgewiesen durch die Einhaltung folgender Normen:

The above mentioned product has been manufactured according to the regulations of the following European directives proven through compliance with the following standards:

Nr. / No.	Richtlinie / Directive
2004/108/EG 2004/108/EC	Elektromagnetische Verträglichkeit - EMV - Richtlinie Electromagnetic compatibility - EMC directive

EMV / EMC	Fachgrundnorm / Generic Standard	Messverfahren / Measurement methods
Störaussendung / Emission	EN 61000-6-4 : 2007	EN 55011 : 2007+A2:2007
Störfestigkeit / Immunity	EN 61000-6-2 : 2005	IEC 61000-4-2: 1995+A1:1998+A2:2001 IEC 61000-4-3: 2006+A1:2007 IEC 61000-4-4: 2004 IEC 61000-4-6: 2008

Nr. / No.	Richtlinie / Directive
2006/95/EG 2006/95/EC	Elektrische Betriebsmittel zur Verwendung innerhalb bestimmter Spannungsgrenzen - Niederspannungsrichtlinie - CE-Kennzeichnung : 95 Electrical equipment for use within certain voltage limits - Low Voltage Directive - Attachment of CE mark : 95

EN/Norm/Standard	IEC/Norm/Standard
EN 61 010-1 : 2001	IEC 1010-1 : 2001

Ort, Datum / Place, date: Wohlen, 2. Oktober.2009

Unterschrift / signature:

 
M. Ulrich J. Brem
Leiter Technik / Head of engineering Qualitätsmanager / Quality manager