

# R2500

## Compact Controllers and Temperature Limiters

3-349-374-03

15/10.11





Contents	Page	Contents	Page
Safety Features and Precautions .....	4	Suppression of Periodic Disturbances .....	22
Maintenance .....	5	Adaptive Measured Value Correction .....	23
Repair and Replacement Parts Service .....	5	Hot-Runner Control .....	24
Product Support .....	5	Feed-Forward Control .....	25
Device Identification .....	6	Parameters Configuration .....	26
Mechanical Installation / Preparation .....	8	Program Controller .....	28
Electrical Connection .....	8	Program Entry .....	30
Operation .....	10	Manual Optimization .....	32
Disabling Modifications .....	11	Self-Tuning .....	36
Performance After Activating Auxiliary Voltage .....	11	Balancing .....	37
Operating Flow Chart .....	12	Limit Value Monitoring .....	38
Automatic Operation / Off .....	13	Limiter .....	38
Manual / Automatic Selection .....	13	Heating Current Monitoring .....	39
Controller Types .....	18	Heating Circuit Monitoring .....	40
Conversion of Parameter Sets .....	19	Alarm History .....	41
Backup Functions .....	19	Data Logger .....	41
PI Performance .....	19	Error Messages .....	42
Extra derivative action for cooling .....	19	Error Acknowledgement .....	43
Configuring the Switching Outputs and the Continuous Output .....	20	Error mask .....	44
Relay Outputs for Actuating Signals .....	20	Replacing an R2400 Controller with an R2500 Controller .....	46
Actuator Output for Contactor .....	21	Technical Data .....	48
Water Cooling .....	21	CompactConfig Configuration Tool .....	49
Configuration of the Controller with Continuous Output .....	21		
Setpoint Ramps .....	22		

## Meanings of Symbols on the Instrument



Indicates EC conformity



Continuous doubled or reinforced insulation



Warning concerning a point of danger  
Attention: observe documentation!



Functional earth terminal,  
earthing for functional purposes only  
(no safety function)



The device may not be disposed of with the trash. Further information regarding the WEEE mark can be accessed on the Internet at [www.gossenmetrawatt.com](http://www.gossenmetrawatt.com) by entering the search term WEEE.

## Safety Features and Precautions

The R2500 controller is manufactured and tested in accordance with safety regulations IEC 61010-1 / DIN EN 61010-1 / VDE 0411-1. If used for its intended purpose, the safety of the user and the device is assured.

**Read the operating instructions completely and carefully before using the device, Follow all instructions contained therein. Make sure that the operating instructions are available to all users of the instrument.**

### Observe the following safety precautions:

- The device may only be connected to an electrical system which complies with the specified nominal range of use (see circuit diagram and serial plate), and which is protected with a fuse or circuit breaker with a maximum nominal current rating of 16 A.
- The installation must include a switch or a circuit breaker which serves as a disconnecting device.

### The controller may not be used:

- If it demonstrates visible damage
- If it no longer functions flawlessly
- After long periods of storage under unfavorable conditions (e.g. humidity, dust or extreme temperature)

In such cases, the instrument must be removed from operation and secured against unintentional use.

## Maintenance

### Housing

No special maintenance is required for the housing. Keep outside surfaces clean. Use a slightly dampened cloth for cleaning. Avoid the use of solvents, cleansers and abrasives.

### Repair and Parts Replacement

Repair and replacement of parts conducted at a live open instrument may only be carried out by trained personnel who are familiar with the dangers involved.

### Return and Environmentally Sound Disposal

The R2500 is a category 9 product (monitoring and control instrument) in accordance with ElektroG (German electrical and electronic device law).

This device is not subject to the RoHS directive.

We identify our electrical and electronic devices (as of August 2005) in accordance with WEEE 2002/96/EC and ElektroG with the symbol shown at the right per DIN EN 50419.

These devices may not be disposed of with the trash. Please contact our repair and replacement parts service department regarding the return of old devices.



## Repair and Replacement Parts Service

If required please contact:

GMC-I Service GmbH  
Service Center  
Thomas-Mann-Str. 20  
90471 Nürnberg, Germany  
Phone +49 911 817718-0  
Fax +49 911 817718-253  
E-Mail [service@gossenmetrawatt.com](mailto:service@gossenmetrawatt.com)  
[www.gmci-service.com](http://www.gmci-service.com)

This address is only valid in Germany. Please contact our representatives or subsidiaries for service in other countries.

## Product Support

If required please contact:

GMC-I Messtechnik GmbH  
Product Support Hotline  
Phone: +49 911 8602-500  
Fax: +49 911 8602-340  
E-Mail: [support@gossenmetrawatt.com](mailto:support@gossenmetrawatt.com)

## Device Identification

Feature				Designation
<b>Compact controller</b> , 48 x 48 mm, IP 67, with self-tuning, 2 <sup>nd</sup> setpoint and 2 alarms, hot-runner functions, data logger, alarm history, program controller, infrared interface				R2500
<b>Controller Type</b>				<b>Outputs</b>
Two-step, three-step, step-action controller				2 transistor, 2 relay A1
Two-step, three-step, step-action controller				2 transistor, 3 relay A2
Continuous, split range controller, discontinuous action controller				1 continuous, 1 transistor, 3 relay A5
<b>Measuring Ranges</b>				
Configurable measurement input				B1
Thermocouple	Type J, L	0 ... 900° C /	32 ... 1652° F	
	Type K, N	0 ... 1300° C /	32 ... 2372° F	
	Type R, S	0 ... 1750° C /	32 ... 3182° F	
	Type B	0 ... 1800° C /	32 ... 3272° F	
	Type C	0 ... 2300° C /	32 ... 4172° F	
	Type E	0 ... 700° C /	32 ... 1292° F	
	Type T	0 ... 400° C /	32 ... 752° F	
Resistance thermometer	Type U	0 ... 600° C /	32 ... 1112° F	
	Pt100	- 200 ... 600° C /	-328 ... 1112° F	
	Ni100	- 50 ... 250° C /	-58 ... 482° F	
	Ohm	0 ... 340 Ω		
Linear		0 ... 50 mV		

Feature	Designation
Measurement input: configurable standard signal 0 / 2 ... 10 V or 0 / 4 ... 20 mA	B2
<b>Auxiliary Voltage</b> 85 ... 265 V AC, 48 ... 62 Hz 20 ... 30 V DC	C1 C2
<b>Extras</b> Heating current monitoring RS 485 data interface	E0 E1
<b>Configuration</b> Default settings Configured per customer requirements	K0 K9
<b>Operating Instructions</b> German English Italian French None	L0 L1 L2 L3 L4

## Mechanical Installation / Preparation

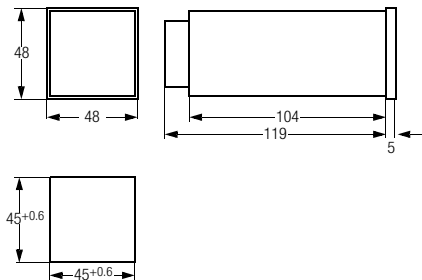

Figure 1: Housing Dimensions and Panel Cutout

The R2500 controller is intended for installation to a control panel. The installation location should be vibration-free to the greatest possible extent. Aggressive vapors shorten the service life of the controller. Requirements set forth in VDE 0100 must be observed during the performance of all work. Work on the device may only be carried out by trained personnel who are familiar with the dangers involved.

Set the housing into the panel cutout from the front, and secure it from

behind at the top and bottom with the two included snap retainers. Several devices can be mounted next to each other without separators at the side.

In general, unobstructed air circulation must be assured when one or several devices are installed. The ambient temperature underneath the devices may not exceed 50 °C.

In order to assure IP 67 protection, an appropriate seal must be installed between the device and the panel.

## Electrical Connection

Connectors: screw terminals for wire with 1.5 square mm cross-section or two-core wire-end ferrules for 2 × 0.75 square mm

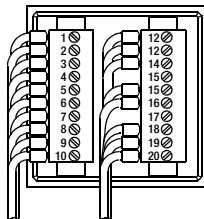
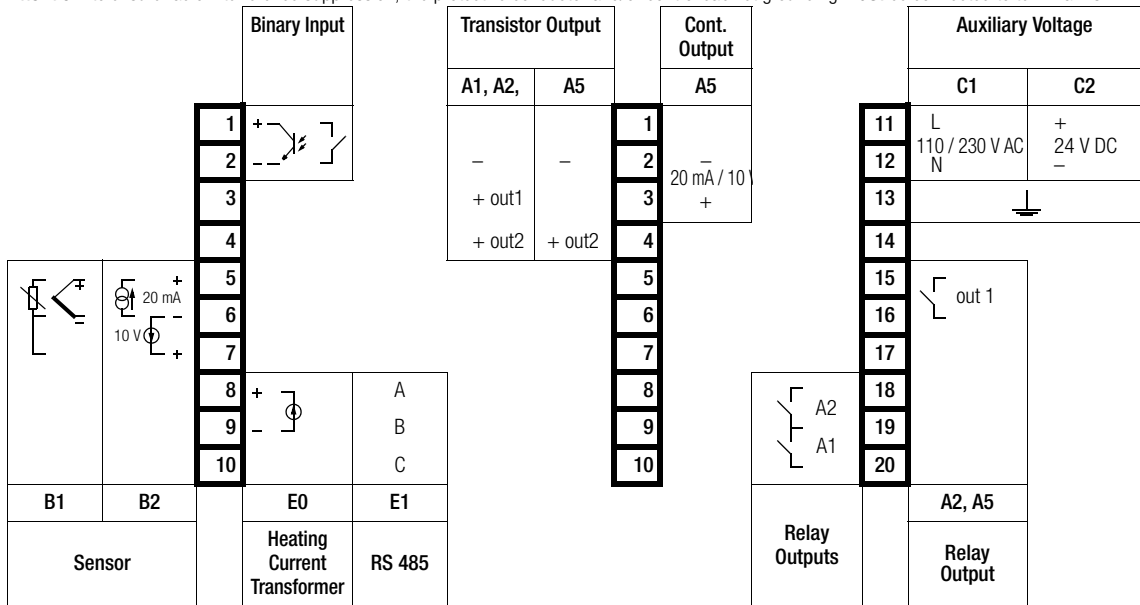

Figure 2: Connector Terminal Positions



**Attention:** to ensure radio interference suppression, the protective conductor and/or control cabinet grounding **must** be connected to terminal 13.



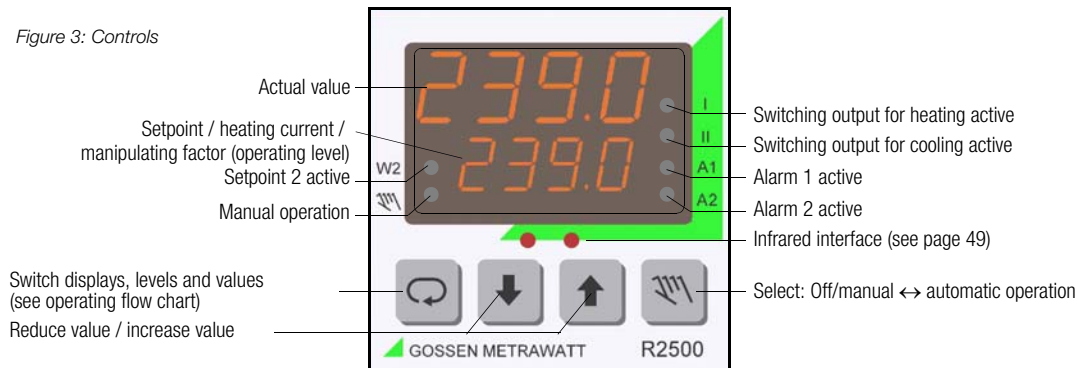

## Operation

Figure 3: Controls



### Setting Values with the Up and Down Scroll Keys

- At the operating level, the setpoint can be adjusted within a range extending from the minimum to the maximum setpoint.
- Configuration and parameter settings can be changed if password protection has not been activated, or if the correct password has been entered.
- In order to avoid erroneous settings, changes must be acknowledged within 5 seconds with the  key.
- The change can be discarded by pressing the  key.

## Disabling Modifications

The default setting (*PSEt = dEF*) allows for modification of all parameters and configurations. The following settings can be used in order to disable the entry of changes:

### Disabling Setpoint Changes

The setpoint can only be adjusted between its minimum and maximum values. The *SPL* and *SPH* parameters must be set accordingly.

### Disabling Changes to Parameters and Configurations

After password protection for device operation has been activated (*PASS* not equal to *diS*), changes can only be made after the correct password has been entered. However, changes are always possible via infrared or bus interface!

### Disabling Self-Tuning

Starting self-tuning by pressing the corresponding keys can be separately disabled with the configuration *tunE = diS*. However, self-tuning can always be started via infrared or bus interface!

## Performance After Activating Auxiliary Voltage

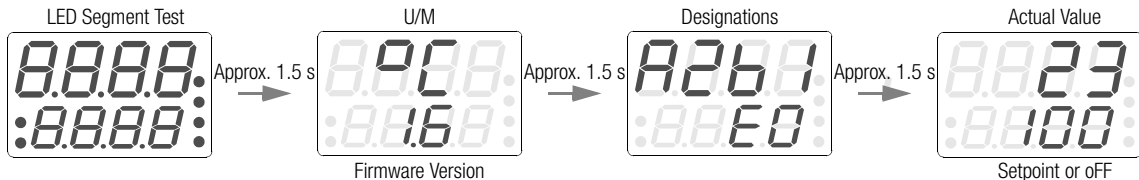

# Operating Flow Chart

## Operating Level

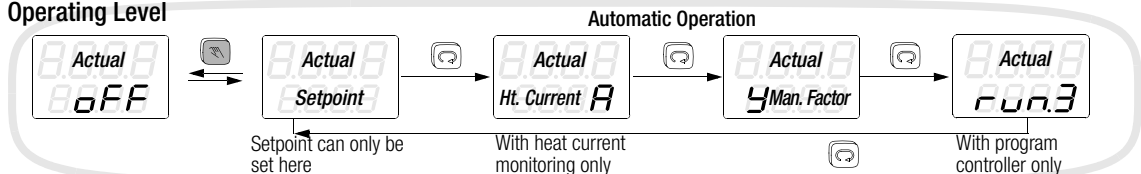

## Parameter Level (page 26)

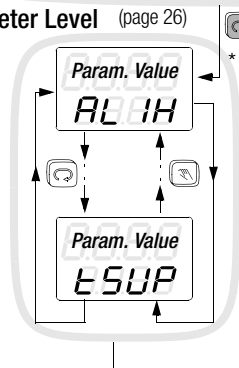

## Configure (page 14)

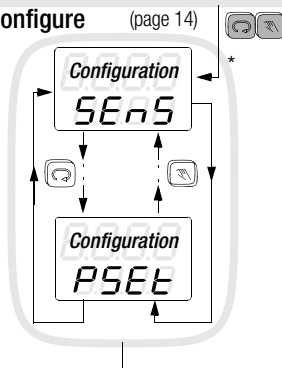

## Program Controller

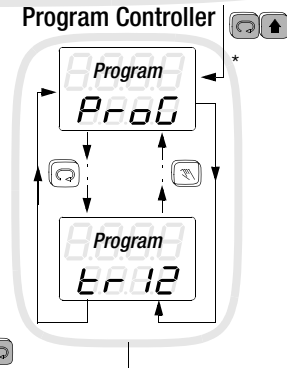



- Press key briefly.   
  Press and hold key until display switches.
- Press and hold both keys until display switches.

\*) If password protection for device operation is activated (configuration: **PASS = EnA**), the correct password must be entered in order to change values. Otherwise **-no-** appears at the display if an attempt is made to change a value.

## Automatic Operation / Off

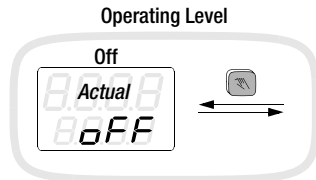
- No alarm function
- No indication of errors



The controller can be deactivated by pressing and holding the  key, if it is configured to on/off.

## Manual / Automatic Selection

- Alarm function and error indication identical to automatic operating mode.
- The actuator outputs are controlled with the scroll keys and not by the controller function.
- Switching between manual and automatic modes is bumpless in both directions.
- PDPI controller: The manipulating factor is displayed as a percentage. Value changes are forwarded immediately to the control outputs.
- Step-action controller: The switching outputs can be adjusted directly with “more” or “less” by pressing the up and down scroll keys.

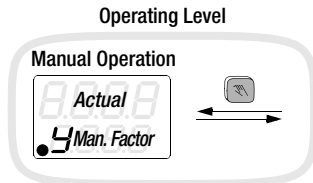

If the  key is configured to manual / automatic

## Configuration

 +  press and hold simultaneously

Configuration	Display	Selection	Standard	Comment
Sensor type	<i>SEnS</i>	Types J, L, K, B, S, R, N, E, T, U, C, Pt 100, Ni 100, Ohm, lin	Type J	Not with standard signal
U/M	<i>SEnS</i>	$1^{\circ}\text{C}$ , $1^{\circ}\text{F}$ , $0.1^{\circ}\text{C}$ , $0.1^{\circ}\text{F}$	$1^{\circ}\text{C}$	
Input quantity	<i>SEnS</i>	$0 - 20 / 4 - 20$ dead / live zero	0 - 20	With standard signal only
Linearization	<i>SEnS</i>	<i>Li n / PH</i> Linear / titration curve	Lin	
Controller type	<i>Co ut</i>	<i>MEAS</i> Measure only <i>POH</i> Actuator <i>OnDF</i> Limit transducer <i>PdP 1</i> 2/3 step, step-action, split range <i>ProP</i> Proportional actuator	PdPI	See page 18
Derivative action	<i>tu 11</i>	<i>di S / EnA</i> -/ Extra derivative action for cooling	diS	only with 3-step controllers
Binary input	<i>In 1</i>	<i>PHLt</i> Pause program controller <i>Prun</i> Start/stop program controller <i>oFF</i> No function <i>SP2</i> Setpoint 2 active <i>Loop</i> Controller on <i>HRnd</i> Manual operation <i>tunE</i> Start self-tuning <i>qul t</i> Clear limit value error <i>FEFD</i> Feed-forward control <i>StUP</i> Start-up active <i>booS</i> Start boosting <i>LoGg</i> Data logger recording <i>dARk</i> Display darkl <i>SEt2</i> Parameter set conversion <i>bACk</i> Backup function	SP 2	The function of the binary input has precedence over operation and configuration.

Configuration	Display	Selection	Standard	Comment	
Binary input	<i>In</i>	<i>StAt</i> <i>dYn</i>	Binary input dynamic, switching by key	StAt	
out1 switching output	<i>Out 1</i>	<i>tr2</i> <i>tr 1</i> <i>PHLt</i> <i>Prun</i> <i>oFF</i> <i>HEAt</i>  <i>Cool</i>  <i>H2O</i> <i>HcLo</i> <i>CcLo</i> <i>Hotr</i> <i>Indu</i> <i>AL2H</i>	Controller 2 Controller 1 Program pause Program running No function Heater, more heat with step-action controller Cooling, more cooling with step-action controller Water cooling Less heat w. step-action controller Less cooling w. step-action controller Hot-runner heat Induction heating 2nd upper limit value	HEAt	See page 20
out2 switching output	<i>Out 2</i>	Same as out1 switching output	oFF		
Switching output selection	<i>Out</i>	<i>nor</i> <i>≡CH</i>	As configured Outputs out1 and out2 exchanged with A1 and A2	nor	See page 20
Continuous Output	<i>Cont</i>	<i>oFF</i> <i>HEAt</i> <i>Cool</i> <i>Proc</i> <i>SP</i>	No function Heater, Cooling, Current controlled variable Current setpoint	oFF	See pages 20 and 21, only if a continuous output is present (designation A5)
Continuous output	<i>Cont</i>	<i>0-20 / 4-20</i> <i>20-0 / 20-4</i>	Dead / live zero dead / live zero invers	0 - 20	

Configuration	Display	Selection	Standard	Comment
Alarm 1	<i>A 1</i>	<i>noc / ncc</i> Operating current / idle current	noc	See page 38
Alarm 2	<i>A 2</i>	<i>noc / ncc</i> Operating current / idle current	noc	
Channel error mask A1	<i>A 1n 1</i>	<i>dEF / 1 ... 3FFF</i>	def	see page 44
Device error mask A1	<i>A 1n 2</i>	<i>0 ... 03FF</i>	0	
Channel error mask A2	<i>A 2n 1</i>	<i>0 ... 3FFF</i>	0	
Device error mask A2	<i>A 2n 2</i>	<i>0 ... 03FF</i>	0	
Alarm 1	<i>AL 1</i>	<i>rEL / Ab5</i> Relative / absolute	rEL	See page 38
Alarm 1	<i>AL 1</i>	<i>nSUP / SUP</i> Start-up inhibiting off / on	nSUP	
Alarm 1	<i>AL 1</i>	<i>nSto / Stor</i> Alarm memory off / on	nSto	
Alarm 2	<i>AL 2</i>	<i>rEL / Ab5</i> Relative / absolute	rEL	
Alarm 2	<i>AL 2</i>	<i>nSUP / SUP</i> Start-up inhibiting off / on	nSUP	
Alarm 2	<i>AL 2</i>	<i>nSto / Stor</i> Alarm memory off / on	nSto	
Limiter	<i>L 1n</i>	<i>no / YES</i>	no	See page 38
Heating circuit monitoring	<i>LbA</i>	<i>no / YES</i>	no	See page 40
Adaptive measured value correction	<i>ANC</i>	<i>no / YES</i>	no	See page 23
Actuator output for contactor	<i>rELA</i>	<i>no / YES</i>	no	See page 21
PI performance	<i>P 1</i>	<i>no / YES</i>	no	See page 19
Manual key function	<i>HKEY</i>	<i>oFF / HRnd</i>	oFF	See page 13
Start self-tuning	<i>tunE</i>	<i>EnA / di 5</i> Enable / disable	EnA	See page 36
Setpoint staircase	<i>SP</i>	<i>rAMP</i> <i>StEP</i> Setpoint ramp Setpoint staircases, configurable with <i>SPuP</i> , <i>SPdn</i> and <i>t SP</i>	rAMP	only for program controller
Actuation inactive	<i>StUP</i>	<i>no / YES</i>	no	See page 24



Configuration	Display	Selection	Standard	Comment
Bus protocol	<i>Prot</i>	<i>r260</i> DIN 19244 E same as R2600 <i>Mod</i> Modbus <i>r217</i> DIN 19244 E same as R0217 <i>hbth</i> HB-Therm	r260	With bus interface only
Baud rate	<i>bAud</i>	<i>96 / 192</i>	9.6	Not with DIN protocoll
Interface address	<i>Addr</i>	<i>0 ... 255</i>	250	With bus interface only
Data logger recording	<i>LoGG</i>	<i>no / YES</i>	no	
Alarm History	<i>HIST</i>	<i>no / YES</i>	no	
Program controller	<i>Prog</i>	<i>EnA / di S</i>	Enable / disable	diS
Password for operation	<i>PASS</i>	<i>EnA / di S</i> <i>1 ... 999</i>	Enable / disable Value	diS See pages 11 and 12
Device settings, parameter set	<i>PSET</i>	<i>Act</i> Retain active configuration <i>dEF</i> Load default settings <i>GEt 1</i> Load user configuration 1 <i>GEt2</i> ... <i>GEt3</i> ... <i>GEt4</i> Load user configuration 4 <i>PuT 1</i> Save active configuration as user configuration 1  <i>PuT2</i> ... <i>PuT3</i> ... <i>PuT4</i> Save active configuration as user configuration 4	Act	Configuration per customer specification (K9) is saved to the user settings. All settings are overwritten during loading!

## Controller Types

Controller Type	Applications
<b>Measure</b> ( <i>Cout = MEAS</i> )	This configuration is intended for temperature monitoring. Limit value monitoring can be configured. System deviation is not used for any other purposes.
<b>Actuator</b> ( <i>Cout = POW</i> )	Same as <b>controller type 1 (measure)</b> In addition, the actuator manipulating factor is read out with the actuating cycle.
<b>Limit transducer</b> ( <i>Cout = OnOF</i> )	The maximum manipulating factor is read out if the actual value is less than the momentary setpoint. The minimum manipulating factor is read out if the actual value is greater than the momentary setpoint plus the dead zone. Switching hysteresis is adjustable, and status changes are possible after each actuating cycle. Actuating cycle time is used as a time constant for an additional input filter.
<b>PDPI controller and PDPI step-action controller</b> ( <i>Cout = PdPI</i> )	The PDPI control algorithm assure short settling time without overshooting. The actuating cycle is at least as long as the selected value. The dead band inhibits switching back and forth between "heating" and "cooling" if no lasting deviation occurs. Selection of these two <b>controller types</b> , namely <b>PDPI</b> and <b>PDPI step-action</b> controller, defines the controller itself on the basis of the output configuration.
<b>Proportional actuator</b> ( <i>Cout = ProP</i> )	The control variable is proportional to system deviation, and a statistical dead zone can be adjusted at the cooling side. Actuating cycle time is used as a time constant for an additional input filter. This controller type is not intended for temperature regulation, because it does not demonstrate the dynamics required for control without overshooting.

## Conversion of Parameter Sets

If the binary input is configured to parameter set conversion (**Set2**), parameter set 2 is loaded when the contact is closed, and parameter set 1 is loaded when the contact is open. The active configuration is overwritten in each case. The W2 LED lights up when parameter set 2 and/or 3 is active.

## Backup Functions

If the binary input is configured to backup function (**BACK**), the momentary actual value is adopted as setpoint value when the contact is closed. Control is inactive. When the contact is open, control is effected with the adopted setpoint value according to configuration.

## PI Performance

The differential component of the PDPI controller type can be attenuated to such an extent by activating PI performance (configuration: **PI = YES**) that practically no more derivative action occurs. As opposed to a pure PI controller, response to setpoint changes can be configured without overshooting. This setting is advisable for control systems which include true delay time.

## Extra derivative action for cooling

In controlled systems in which cooling has much better or worse thermal contact than heating, control performance for a cooling work point can be improved by setting the **tu II** configuration to **EnA**. This makes it possible to set the delay time for cooling (parameter **tu II**) independently. In the case of **water cooling**, half the derivative action is automatically used for cooling when configuration **tu II = diS** has been selected.

## Configuring the Switching Outputs and the Continuous Output

Switching output out1 is configured with a 2-step heating controller as a standard feature (relay or transistor output, depending upon variant).

Control performance (2-step heating or cooling, 3-point discontinuous, step-action controller, continuous-action controller, split range controller) is determined by the configuration selected for the actuating outputs. See also the “Configuration” table on page 15.

- Actuators for heating and cooling are selected independent of each other.
- If 2-step control is required, heating and cooling outputs may not be configured simultaneously for the respective controller.
- Both switching outputs can be assigned to the same controller output for separate control of several actuators with a single controller output.
- If a continuous and a discontinuous output are both configured for heating (or cooling) at the same time, the channel performs like a continuous-action controller and the discontinuous output is inactive.
- If, inadvertently, only one “Less” output is configured for heating (or cooling), it remains inactive.
- Settings can be freely combined regardless of **controller type**.

## Relay Outputs for Actuating Signals

If two relay outputs are required for the actuating signals, for example in the case of three-step or step-action control, the alarm outputs can be exchanged with the actuator outputs.

The **Out = XCh** configuration (see page 15) exchanges the functions of **out1** with **A1** and **out2** with **A2**.

## Actuator Output for Contactor

If, during ascertainment of control parameters (manual optimization or self-tuning), a **cycle time** results which is significantly shorter than advisable for the service life of the contactor, **cycle time** can be increased to the limit of system controllability by configuring the actuating outputs for contactor control (*rELA = YES*). If the bit is set before self-tuning is started, cycle time is set to the highest possible value by the self-tuning function.

## Water Cooling

In order to account for the disproportionately powerful cooling effect which prevails when water is evaporated, the cooling control variable can be read out in a modified fashion by configuring the switching output for water cooling (*Outx = H2O*).

## Configuration of the Controller with Continuous Output

Switching back and forth between current output and voltage output is automatic based upon load impedance.

**Continuous output = heating or cooling**

*Cont = HEAt or Cool*

The manipulated variable is read out within a range of 0 to 100% depending upon controller type.

**Continuous output = controlled variable or setpoint**

*Cont = Proc or SP*

The momentary controlled variable of the currently valid setpoint is read out.

The read-out is scaled with the *rnL* and *rnH* parameters.

## Setpoint Ramps

Function	The parameters <b>SPuP</b> / <b>SPdn</b> cause a gradual temperature change (rising / falling) in degrees per minute. Activated by: <ul style="list-style-type: none"><li>– Switching auxiliary power on</li><li>– Changing the momentary setpoint, activating setpoint 2</li><li>– Switching from manual to automatic operation</li></ul>
Setpoint display	The targeted setpoint is displayed (not the currently valid setpoint) with a blinking <b>r</b> at the left-hand digit.
Limit values	<b>Relative</b> limit values make reference to the ramp, not the targeted setpoint. As a rule, no alarm is triggered for this reason.

## Suppression of Periodic Disturbances

If the measured value is superimposed with highly periodic oscillation which, for example, occurs due to cyclical withdrawal of energy from the control loop, the manipulated value may fluctuate between its extreme values resulting in unsatisfactory control results.

If the period is constant, this oscillation can be filtered out by setting the period in the **oscillation suppression tSUP** parameter. This is accomplished by means of narrow-band filtering in order to remove the signal component with the selected period, which is then disregarded for measuring signal control. The actual values for the display are not influenced.

As opposed to adaptive measured value correction (see also page 23), oscillation can also be suppressed with this function whose periods are greater than half of the system's delay time.

Periods can be selected within a range of 0.3 to 25 seconds, and the filter remains inactive for other setting values.

Due to the fact that this suppression filter influences control dynamics, ascertainment of control parameters by means of self-tuning or manual optimization has to be performed while oscillation suppression is active.

## Adaptive Measured Value Correction

If a control loop is interfered with by periodic disturbance of the actual value, control can be improved by activating adaptive measured value correction. Periodic disturbance is thus suppressed, without impairing the controller's ability to react to system deviations. Correction is adapted to the oscillation amplitude of the disturbance to this end, and only the mean value is forwarded to the controller.

Adaptation of correction to the disturbance is matched to prevailing control dynamics and requires no further parameters.

Prerequisites for **improved** control:

- The oscillation amplitude of the disturbance must be constant, or may only change slowly.
- The oscillation period must be less than half of the system's delay time (parameter ***tu***).

Due to the fact that correction greatly influences actual value ascertainment, control may also be **worsened**, for example if:

- Measured value deviations are irregular
- Individual measured value outliers occur
- Fluctuation is not periodic
- The disturbance is noise-like

## Hot-Runner Control

By configuring the switching output for heating as a hot runner (*Outx = Hotr*), the manipulated variable is read out as a rapidly pulsating signal, i.e. actuation cycle time is 0.1 seconds regardless of the **actuation cycle time** parameter setting.

With the help of this configuration, the **start-up circuit** and **boost** functions are also enabled.

### Start-Up Circuit

The start-up circuit is enabled with the *StUP = YES* configuration, or by means of the binary input when it has been configured as follows: *In1 = StUP*.

The start-up circuit is only enabled for **controller type PDPI**. No start-up occurs for other controller types.

The start-up procedure is initiated if the actual value is more than 2 °C less than the **start-up setpoint** after auxiliary voltage is turned on (reset) or after the off state has been ended, or if the actual value drops to more than 40 °C less than the **start-up setpoint** after a start-up procedure has been completed or during dwell time.

Start-up continues until the actual value exceeds the **start-up value** minus 2 °C.

Dwell time then begins, The control variable is limited to the **start-up manipulating factor**, which is selected with the **dwell time** parameter.



The actuation procedure is ended as soon as dwell time has expired.

The controller then regulates temperature to the valid setpoint.

If the currently valid setpoint is still so far beneath the start-up setpoint that the condition for ending actuation cannot be fulfilled, the start-up procedure continues indefinitely. In this case, control variable limiting by means of **maximum manipulating factor** would be advisable.



### Temporary Setpoint Increase (boosting)

Temporarily increasing the setpoint in the hot-runner control mode can be used to free clogged mold nozzles of “frozen” material remnants. This procedure is triggered by bit 3 of the controller function, which is set via the interface, keyboard or the binary input. The binary input must be configured as follows to this end:  $In1 = booS$ . If the binary input is not used to this end, setpoint increase is activated or stopped by simultaneously pressing and holding the keys  . Boosting is ended by clearing this bit, or is stopped automatically after maximum boosting time has elapsed. The relative increase is saved to the **setpoint increase** parameter, and the maximum duration of the increase is saved to the **boost time** parameter. The increase effects the setpoint or setpoint 2 only, and has no influence on the start-up setpoint or the ramp function. The setpoint value, and not the increase, is indicated with a **b** in the left digit.

## Feed-Forward Control

When configured as a discontinuous or continuous-action controller (not as a step-action controller) control quality can be significantly improved by means of feed-forward control where abrupt load fluctuations prevail, if the binary input is configured for feed-forward control ( $In 1 = FEFO$ ).

- When the contact at the binary input is closed, the controller’s manipulating factor is increased by an amount of  $YFF$ ,
- and is reduced by the same value when the contact is opened.
- No function during self-tuning.

Example: If a machine requires an average of 70% heating power during production operation, but only 10% during idle time, the difference of  $YFF$  is set to 60%, and the binary input is only activated during production.

## Parameters Configuration

 Press and hold

X1 = lower range limit, X2 = upper range limit, MRS = X2 - X1

Parameters	Display	Range	Standard	Comments
Upper limit value for relay A1	<i>AL IH</i>	oFF, 1 ... MRS/2 oFF, X1 ... X2	oFF oFF	Relative (= default config.) Absolute
Lower limit value for relay A1	<i>AL IL</i>			
Upper limit value for relay A2	<i>AL2H</i>			
Lower limit value for relay A2	<i>AL2L</i>			
Setpoint 2	<i>SP 2</i>	<b><i>SPL ... SPH</i></b>	X1	
Ramp for rising setpoints	<i>SPuP</i>	oFF, 1 ... MRS/2 per min.	oFF	See page 22
Ramp for falling setpoints	<i>SPdn</i>	oFF, 1 ... MRS/2 per min.	oFF	
Heating current setpoint (see balancing)	<i>ANPS</i>	Auto, oFF, 0.1 ... <b><i>A H</i></b>	oFF	Not with step-action controller or bus interface
Proportional band heating	<i>Pb I</i>	0 ... MRS/2	50	
Proportional band cooling	<i>Pb II</i>	0 ... MRS/2	50	Only with 3-step controllers
Dead band H/C	<i>dbnd</i>	0 ... MRS/2	0	Not with 2-step controllers
Path delay time	<i>tu</i>	0 ... 900 s	50 s	
Cooling path delay time	<i>tu II</i>	0 ... 900 s	50 s	Only with 3-step controllers if extra derivative action has been configured
Read-out cycle time	<i>tc</i>	0.1 ... 300 s	1 s	
Motor run-time	<i>ty</i>	1 ... 600 s	60 s	Only with step-action controllers
Switching hysteresis	<i>HYS t</i>	0 ... MRS/2	4	For limit value monitoring and limit transducers

Parameters	Display	Range	Standard	Comments
Maximum setpoint	<i>SP H</i>	<b><i>SPL</i></b> ... X2	X2	Limiting the setpoint entry
Minimum setpoint	<i>SP L</i>	X1 ... <b><i>SPH</i></b>	X1	
Maximum manipulating factor	<i>Y H</i>	-100 ... 100%	100%	
Minimum manipulating factor	<i>Y L</i>	-100 ... 100%	-100%	
Actual value correction	<i>CAL</i>	-MRS/2 ... +MRS/2	0	Not with standard signal
Actual gain value	<i>GAIN</i>	0 ... 500%	100%	
Decimal point position	<i>dPt</i>	0, 0.1, 0.02, 0.003	0	With standard signal only
Upper range limit, standard signal	<i>rn H</i>	<b><i>rn L</i></b> ... 9999	100	
Lower range limit, standard signal	<i>rn L</i>	-1999 ... <b><i>rn H</i></b>	0	
Manip. factor for actuation mode	<i>Y SE</i>	-100 ... 100%	0	
Manip. factor for feed-forward control	<i>Y FF</i>	-100 ... 100%	0	See page 25
Sensor error manipulating factor	<i>Y SE</i>	-100 ... 100%	0	See page 42
Actuation setpoint	<i>SPSU</i>	<b><i>SPL</i></b> ... <b><i>SPH</i></b>	0	For hot-runner controllers only, see pages 24 and 25
Start-up manipulating factor	<i>Y SU</i>	-100 ... 100%	10	
Dwell time	<i>t SU</i>	0 ... 300 s	0	
Boosting (setpoint increase)	<i>SPbo</i>	0 ... MRS/2	0	
Boosting time	<i>t bo</i>	0 ... 600 s	0	
Oscillation inhibiting	<i>tSUP</i>	oFF, 0.3 ... 25 s	oFF	See page 22

## Program Controller

<b>Activation</b>	At the configuration level with <b>ProG = EnA</b>
<b>Function</b>	<p>The current setpoint is determined exclusively by the program.</p> <p>Eight programs with twelve segments each are saved to the controller and can be selected.</p> <p>The functions which otherwise influence the setpoint, such as setpoint swapping and setpoint ramps, as well as the start-up circuit and boosting for hot-runner control, are without function.</p>
<b>Program</b>	Each of the twelve program segments is defined by means of segment duration, targeted setpoint and the control tracks, and the program can be set to end upon completion of the first through the eleventh segment as well.
<b>Sequence</b>	<p><b>StoP</b> The program has been completed or stopped, or hasn't yet been started (after a reset). The controller and the actuator outputs are inactive, relative limit value errors are suppressed. The momentary setpoint is set to the actual value. The program is started over again after it has been stopped.</p> <p><b>run.X</b> The program has been started, possibly automatically after a reset (X stands for the current segment). The controller and the actuator outputs are active, relative limit value errors are enabled. Segment 1 is always executed when the program is started, and the initial setpoint is the actual value. The program can be started and stopped with a binary input: <b>In1 = Prun</b>.</p> <p><b>Wt.X</b> Same as for <b>run.X</b>. If "wait until setpoint is reached" has been selected (with <b>WAI = YES</b>), the program waits until system deviation amounts to only 2° C before activating the next segment.</p>

**hLt.X** The running program has been halted, the momentary setpoint has been frozen (X stands for the current segment).  
The program can be halted with a binary input: **In1 = PhLt**.

### Control tracks

Two control tracks can be activated for the duration of the segments. They can be assigned to available switching outputs with the setting: **Out... = tr...**

The states **run** and **hLt** can also be assigned to available switching outputs with the settings: **Out... = Prun** and **Out... = PhLt**.

### Control parameters

When the program controller is active, the control parameters should not (cannot) be set manually or by means of self-tuning, because a constant setpoint is required for usable optimization results.

Select **ProG = diS** to this end.

### Display

The displays are supplemented as follows at the operating level:

The momentary setpoint appears at the **setpoint display** when a program is running, and only dashes appear after the program has been ended because there is no longer an active setpoint. The setpoint cannot be changed.

A **status display** also appears. Current status, namely **StoP**, **run.X**, **Wt.X** or **hLt.X** (X stands for the current segment), appears at the bottom display.

### Operation

The sequence can be controlled in the status display with the help of the up and down scroll keys, if it has not been configured to binary inputs.

In order to avoid erroneous settings, changes must be acknowledged within 5 seconds with the  key.

The change can be discarded by pressing the  key.

## Program Entry

 +  Press and hold simultaneously

Configuration	Display	Selection	Standard	Comment
Program selection	<i>Prog</i>	<i>no 1</i> Load program 1 <i>... no 8</i> Load program 8 <i>Put 1</i> Save current program to program 1 <i>...Put 8</i> Save current program to program 8 <i>clr</i> Delete current program	no. 1	
Performance after reset	<i>Auto</i>	<i>Stop / run</i>	StoP	Valid for all 8 programs
Wait Until Setpoint is reached	<i>HR, t</i>	<i>no / YES</i>	no	Valid for all 8 programs
Type of segments	<i>SEGS</i>	<i>rAMP / SLEEP</i> Ramps/increments	rAMP	Valid for all 8 programs
Unit of time for segments	<i>t, NE</i>	<i>n-S / H-n</i> Seconds / minutes	M-S	Valid for all 8 programs
Duration of segment 1	<i>NS 1</i>	0:00 ... 99:59	0:00	
Target setpoint, segment 1	<i>SP 1</i>	<i>SPL ... SPH</i>	0°C	
Control tracks, segment 1	<i>tr 1</i>	---- ... 21	----	Specified numbers designate active control tracks.
Duration of segment 2	<i>NS 2</i>	<i>End</i> End of program 0:00 ... 99:59	End	If <b>End</b> is selected, no further entries are displayed.
Target setpoint, segment 2	<i>SP 2</i>	<i>SPL ... SPH</i>	0°C	
Control tracks, segment 2	<i>tr 2</i>	---- ... 21	----	
...				

Configuration	Display	Selection	Standard	Comment
Duration of segment 12	<i>MS 12</i>	<i>End, 0:00 ... 99:59</i>	End	
Target setpoint, segment 12	<i>SP 12</i>	<i>SPL ... SPH</i>	0°C	
Control tracks, segment 12	<i>tr 12</i>	<i>---- ... 21</i>	----	

### Example:

Desired temperature-time profile:

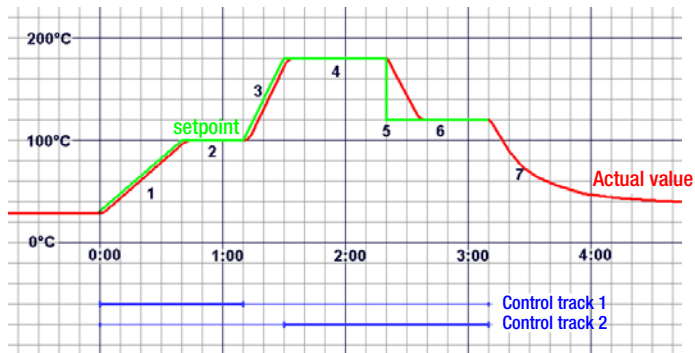

The pertinent program:

Segment	1	2	3	4	5	6	7
Duration <i>MS 1...7 (HM 1...7)</i>	0:40	0:30	0:20	0:50	0.00	0:50	End
Setpoint <i>SP 1...6</i>	100	100	180	180	120	120	—
Tracks <i>tr 1...6</i>	---1	---1	----	--2-	--2-	--2-	—

## Manual Optimization

Parameters **Pb I**, **Pb II**, **tu** and **tc** are determined by means of manual optimization in order to maintain optimized controller dynamics. A start-up test or an oscillation test is performed to this end.

### Preparation

- **Complete configuration** (page 14) and **parameter settings** (page 26) must first be performed for use of the controller.
- **Deactivate the program controller**, because a constant setpoint is required for the optimization procedure.
- The actuators should be deactivated with the **Off** or **Manual Operation** function (page 13).
- A **recorder** must be connected to the sensor and adjusted appropriately to prevailing circuit dynamics and the setpoint.
- For 3-step or split range controllers, on and off time of the switching output for heating or the continuous output must be recorded (e.g. with an additional recorder channel or a stopwatch).
- Configure **limit transducer** ( $Cout = OnOF$ ).
- Set read-out cycle time to the minimum value:  $tc = 0.1$ .
- If possible, deactivate manipulating factor limiting:  $YH = 100$ .
- Reduce (or increase) the **setpoint** so that overshooting and undershooting do not cause any impermissible values.

### Performing the Start-Up Test

- **dbnd = MRS** Setting for 3-step and split range controllers (switching output for cooling may not be triggered)
- **dbnd = 0** Setting for step-action controllers (switching output for cooling must be triggered)
- Start the recorder.
- Activate the actuators with **Automatic Operation**.
- Record two overshoots and two undershoots. *Actuation test is now complete for 2-step, continuous-action and step-action controllers. Continue as follows for 3-step and split range controllers:*
- Set **dbnd** to **0** in order to cause further overshooting with active switching output for cooling. Record two overshoots and two undershoots.
- Record **on-time**  $T_I$  and **off-time**  $T_{II}$  for the last oscillation at the switching output for cooling or the continuous output.



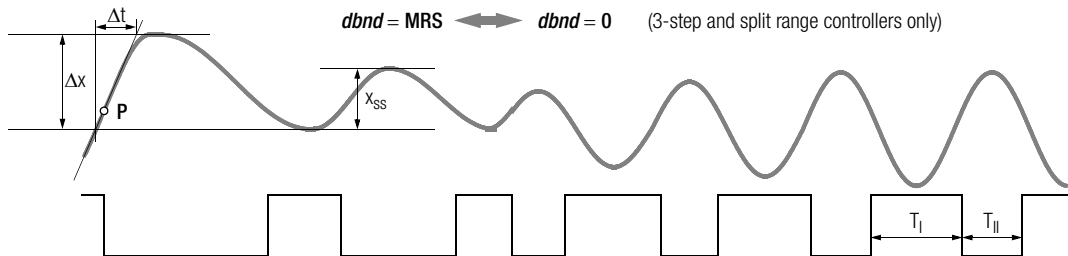

### Evaluating the Start-Up Test

- Apply a tangent to the curve at the intersection of the actual value and the setpoint, or the cut-off point of the output.
- Measure time  $\Delta t$ .
- Measure oscillation amplitude  $x_{ss}$ , or for step-action controllers overshooting  $\Delta x$ .

	Parameter Value				
<i>tu</i>	$1.5 \cdot \Delta t$			$\Delta t - (tY / 4)$	
<i>tc</i>	$tu / 12$			$tY / 100$	
<i>Pb I</i>	$x_{ss}$		$2 \cdot x_{ss}$		$\Delta x / 2$
<i>Pb II</i>	–	$Pb I \cdot (T_I / T_{II})$	–	$Pb I \cdot (T_I / T_{II})$	–
<b>Parameter</b>	<b>2-step controller</b>	<b>3-step controller</b>	<b>Cont.-action controller</b>	<b>Split range controller</b>	<b>Step-action controller</b>

If manipulating factor limiting was active, the proportional band must be corrected:

**YH** positive: **Pb I** multiply by  $100\% / YH$

**YH** negative: **Pb II** multiply by  $-100\% / YH$

## Performing the Oscillation Test

If a start-up test is not possible, for example if neighboring control loops influence the actual value too greatly, if the switching output for cooling must be active in order to maintain the actual value (cooling operating point), or if optimization is required directly to the setpoint for any given reason, control parameters can be determined by means of sustained oscillation. However, calculated values for  $tu$  may be very inaccurate in this case under certain circumstances.

- Preparation as above. Test can be performed without a recorder if actual value is observed at the display, and if times are measured with a stopwatch.
- **dbnd = 0** Setting for 3-step, split range and step-action controllers
- Activate the actuators with **Automatic Operation**, and if applicable start the recorder. Record several oscillations until they become uniform in size.
- Measure **oscillation amplitude**  $x_{SS}$ .
- Record **on-time**  $T_I$  and **off-time**  $T_{II}$  for the oscillations at the switching output for heating or the continuous output.

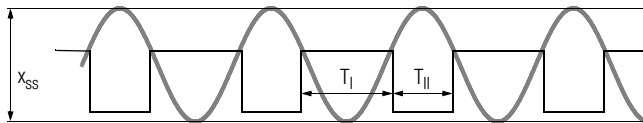

## Evaluating the Oscillation Test

		Parameter Value			
$tu$ <sup>1</sup>		$0.3 \cdot (T_I + T_{II})$		$0.2 \cdot (T_I + T_{II} - 2tY)$	
$tc$		$tu / 12$		$tY / 100$	
$Pb I$	$x_{SS}$	$\frac{x_{SS} \cdot T_{II}}{(T_I + T_{II})}$	$2 \cdot x_{SS}$	$\frac{2 \cdot x_{SS} \cdot T_{II}}{(T_I + T_{II})}$	$x_{SS} / 2$
$Pb II$	–	$Pb I \cdot (T_I / T_{II})$	–	$Pb I \cdot (T_I / T_{II})$	–
<b>Parameters</b>	<b>2-step controller</b>	<b>3-step controller</b>	<b>Cont.-action controller</b>	<b>Split range controller</b>	<b>Step-action controller</b>

<sup>1</sup> If either  $T_I$  or  $T_{II}$  is significantly greater than the other, value  $tu$  is too large.

Correction with manipulating factor limiting **YH** positive: **Pb I** multiplied by 100 % / **YH**  
**YH** negative: **Pb II** multiplied by -100% / **YH**

Correction for step-action controllers in the event that  $T_I$  or  $T_{II}$  is smaller than **tY**:

**Pb I** multiplied by  $\frac{tY \cdot tY}{T_I \cdot T_I}$ , if  $T_I$  is smaller, or by  $\frac{tY \cdot tY}{T_{II} \cdot T_{II}}$ , if  $T_{II}$  is smaller.

The value for **tu** is very inaccurate in this case. It should be optimized in the closed loop control mode.

### Closed Loop Control Mode

The closed loop control mode is started after self-tuning has been completed:

- Configure the desired control algorithm with **controller type (Cout)**.
- Adjust the **setpoint** to the required value.
- For 3-step, split range and step-action controllers, the dead band can be increased from **dbnd** = 0, if control of the switching outputs (or continuous output) changes too rapidly, for example due to an unsteady actual value.

## Self-Tuning

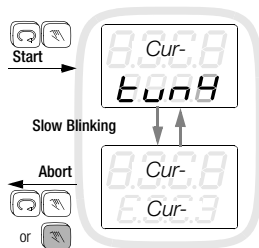



Self-tuning is used to optimize controller dynamics, i.e. the **Pb I**, **Pb II**, **tu** and **tc** parameters are set.

### Preparation

- Complete configuration must be performed before self-tuning is started.
- The setpoint value is adjusted to the value which is required after self-tuning.
- Deactivate the program controller.

### Start





- Self-tuning can only be started if it has been enabled (configuration: **tunE = EnA**).
- Briefly pressing   both keys simultaneously at the operating level triggers self-tuning. Self-tuning cannot be started in the “actuator” or “limit transducer” mode.
- **tun1...tun9** blinks at the display at all levels during self-tuning.
- The controller is switched to the automatic operating mode after self-tuning has been successfully completed.

- In the case of 3-step controllers, cooling is activated if the upper limit value is exceeded in order to prevent overheating. Self-tuning then performs an oscillation test around the setpoint.

### Sequence

- The setpoint which is active when tuning is started remains valid and can no longer be changed.
- Activation or deactivation of setpoint 2 does not become effective.
- Selected setpoint ramps are not taken into consideration.
- If started at the operating point (actual value approximates the setpoint value), overshooting cannot be avoided.
- There are no time limitations for the sequence. Self-tuning may take quite a long time, depending upon the control system.

### Abort

- Self-tuning can be aborted at any time with the   key (→ automatic operating mode), or by switching off with the  key.
- If an error occurs during self-tuning, the controller no longer reads out an actuating signal. In this case, self-tuning must be aborted with the   key. Additional information regarding error messages upon request.

Self-tuning is enabled upon shipment from the factory (default setting). Starting the self-tuning function can be disabled in the configuration.

# Balancing

## Thermocouple Correction (parameter: *CAL*)

The correction value is selected in °C / °F. The displayed correction value is added to the measured temperature.

## Cable Compensation for Pt 100 with 2-Wire Connection (parameter: *CAL*)

Balancing is performed manually if the sensor temperature is known:

*CAL* = known sensor temperature – displayed temperature value

## Correction of a Temperature Gradient (parameter: *GAin*)

If the measured temperature value is not to be displayed, but rather a value which deviates from it, the *GAin* parameter is set to a value other than 100%:

$$GAin = \frac{\text{temperature to be displayed in } ^\circ\text{C} \cdot 100\%}{\text{measured temperature in } ^\circ\text{C}}$$

## Scaling for Heating Current Monitoring (parameter: *A H*)

The default setting for the GTZ 4121 is 42.7 A.

If the GTZ 4121 current transformer is not used for acquiring heating current, the current value must be selected at which the utilized transformer generates an output voltage of 10 V DC.

## Ascertaining the Nominal Heating Current Value (parameter: *AMPS*)

By setting *AMPS* = *Auto*, control is interrupted for about 1 second, heating is activated and heating current is measured and saved as the nominal value. If the value is not equal to zero, heating current monitoring is automatically activated.

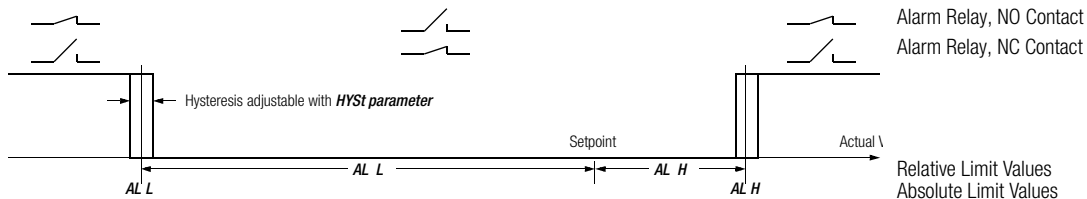

## Limit Value Monitoring



**Start-up inhibiting:** Alarm suppression is active during start-up (configuration:  $ALx = SUP$ ) until temperature has exceeded the lower limit level for the first time. During cooling, suppression is active until temperature has fallen below the upper limit value for the first time. It is active when auxiliary power is activated, if the current setpoint is changed or setpoint 2 is activated, or if switching takes place from Off to Automatic Operation.

## Limiter

If a controller needs to be deactivated in the event of a limit value violation within the control loop, the controller must be configured as a limiter ( $LIM = YES$ ). The limiter can be combined with all **controller types**.

- The limiter responds to the **second limit value**, which must be set and configured accordingly.
- The controller is deactivated as soon as a second limit value is violated. The controller becomes active again when there are no more limit value errors.
- If the controller is to remain continuously deactivated after limit value monitoring has been triggered, the alarm memory must be activated (configuration:  $AL2 = Stor$ ).
- The limit value errors must then be cleared in order to reactivate the controller. This is accomplished by pressing the  key and acknowledging the **Quit AL** display within 5 seconds with the  key.
- These errors can also be cleared with the binary input, if it has been configured to clear limit value errors ( $In 1 = quit$ ).

## Heating Current Monitoring

Current Measurement	Heating current is acquired with an external transformer. Compatible with R2400 with GTZ 4121 for alternating and 3-phase current.
Function	An alarm is triggered if the current setpoint is fallen short of by more than 20% with activated heat (control output active), or if current is not “off” when the heat is switched off. The alarm is not triggered until heating current is high enough when the switching output for heating is active, <u>and</u> when current drops to zero when the switching output for heating is inactive. Monitoring is only active if discontinuous heating has been selected in the configuration, and not in the case of continuous and step-action controllers.
Threshold	The default monitoring threshold is 20%.
<b>AMPS</b> current setpoint	Heater phase current is entered for this parameter. <b>AMPS</b> can be set to <b>Auto</b> for automatic adjustment with the heater switched on. The measured current value is saved to memory.
Activation	Parameter <b>AMPS</b> not set to <b>oFF</b> .

## Heating Circuit Monitoring

- Function
  - Can be set to active or inactive with the **LbA** configuration
  - Without external transformer, without additional parameters
  - Assumes correct optimization of **tu** and **Pb I** control parameters!  
Due to the fact that self-tuning generates other results in certain cases when heating circuit monitoring is activated, heating circuit monitoring must be activated **before** self-tuning is started.
  - In the event of manual optimization or subsequent adaptation of control parameters, the lower limit for the **tu** parameter must be observed:  
$$\text{Minimum } tu = \frac{2 \cdot Pb I}{\Delta\vartheta / \Delta t}$$
$$\Delta\vartheta / \Delta t = \text{maximum temperature rise during start-up}$$
  - Error message **LE** appears after approximately 2 times **tu**, if heat remains on at 100% and measured temperature rise is too small.
  - Monitoring is not active:
    - Where controller type = limit transducer, actuator or step-action controller
    - During self-tuning
    - With standard signal input (designation B2)
    - Where manipulating factor limiting **YH** < 20%



## Alarm History

- The alarm history includes 100 error status entries with the respective time stamps. Whenever at least one entire bit of the overall error status changes, the complete error status is saved with the current time stamp.
- Recording is started over each time the device is reset, and data are lost if auxiliary power fails. Recording can be activated with the setting **HIST = YES** in the configuration, or via interfaces.
- After the ring buffer has been filled to capacity with 100 entries, the oldest entry is deleted each time a new one is recorded.
- Entries can only be read out via the bus interface or the infrared interface. See the interface description for detailed information.



## Data Logger

- The data logger has enough capacity for 3600 sampled value pairs including actual values and manipulated variables. The logger sampling cycle can be configured within a range of 0.1 to 300.0 seconds. This results in recording times of 0.1 to 300 hours (6 minutes to 12 days).
- Recording must be started over again each time the device is reset, and data are lost if auxiliary power fails.
- Recording can be started via a binary input, with the setting **LOGG = YES** in the configuration or via interface.
- After the ring buffer has been filled to capacity with 3600 entries, the oldest values are deleted as new ones are recorded.
- Entries can only be read out via the bus interface or the infrared interface. See the interface description for detailed information.

## Error Messages

Responses in the event of an error:

1. Alarm output A1 is activated; its performance is determined by the configuration (see page 16).
2. LED A1 blinks at all levels, but the error message only appears at the operating level (upper display blinks).
3. Exceptions and additional information are included in the following table:

Display		Error Message Source	Response	Remedy																	
<i>SE H</i>	sensor error high	Broken sensor or actual value > upper range limit	<table border="1"> <thead> <tr> <th>Controller Sort</th> <th colspan="2">Manipulating Factor Read-Out</th> </tr> </thead> <tbody> <tr> <td rowspan="2">2 or 3-step</td> <td><i>YSE</i> = -100/0/100%</td> <td><i>YSE</i> ≠ -100/0/100%</td> </tr> <tr> <td>-100/0/100%</td> <td>If the controller has settled in: last "plausible" manip. factor, If not: <i>YSE</i></td> </tr> <tr> <td>Step</td> <td colspan="2">Control outputs inactive</td> </tr> <tr> <td>On/Off ctrl.</td> <td colspan="2"><i>YSE</i></td> </tr> <tr> <td>Actuator</td> <td colspan="2">No response to error</td> </tr> </tbody> </table>	Controller Sort	Manipulating Factor Read-Out		2 or 3-step	<i>YSE</i> = -100/0/100%	<i>YSE</i> ≠ -100/0/100%	-100/0/100%	If the controller has settled in: last "plausible" manip. factor, If not: <i>YSE</i>	Step	Control outputs inactive		On/Off ctrl.	<i>YSE</i>		Actuator	No response to error		1
Controller Sort	Manipulating Factor Read-Out																				
2 or 3-step	<i>YSE</i> = -100/0/100%	<i>YSE</i> ≠ -100/0/100%																			
	-100/0/100%	If the controller has settled in: last "plausible" manip. factor, If not: <i>YSE</i>																			
Step	Control outputs inactive																				
On/Off ctrl.	<i>YSE</i>																				
Actuator	No response to error																				
<i>SE L</i>	sensor error low	Sensor polarity reversed or actual value < lower range limit																			
<i>CE</i> Heating current display	current error	Current transformer has reversed polarity, is unsuitable or defective	Same as heating current monitoring alarm, continues to control temperature	2																	
<i>no t</i>	no tune	Self-tuning cannot be started (controller sort: "actuator" or "limit transducer").	No response to error, error display remains until acknowledged (see below).	-																	
<i>tE 2</i>	tune error 2	Disturbance in self-tuning sequence in step 1 ... 9 (in this case step 2)	Control outputs inactive, self-tuning must be aborted with the  and  keys.	3																	

Display		Error Message Source	Response	Remedy
<i>LE</i>	loop error	Measured temperature rise is too small with heat on at 100%	Control outputs inactive, error message remains until acknowledged (see below).	4
<i>PE</i>	parameter error	Parameter not within permissible limits	Control outputs inactive, the parameter level is disabled.	5
<i>dE</i>	digital error	Error detected by digital component monitoring	Control outputs inactive	6
<i>AE</i>	analog error	Hardware error detected by analog component monitoring	Control outputs inactive	6

### Remedies

1. Eliminate sensor error.
2. Inspect current transformer.
3. Avoid disturbances which impair the self-tuning sequence, e.g. sensor errors.
4. Close the control loop: Check the sensor, the actuators and the heater for correct functioning. Check sensor-heater assignments (wiring). Correctly optimize control parameters *tu* and *Pb I*.
5. Restore default configuration and default parameters, and then reconfigure or load user-defined default settings.
6. Arrange for repair at authorized service center.

## Error Acknowledgement

Errors are acknowledged by pressing the  key and acknowledging the **Quit AL** display within 5 seconds with the  key.

## Error mask

With the default setting (configuration **A1M1 = def**), relay output A1 reads out alarms from limit value monitor 1, as well as all other errors (sensor errors, heating current errors etc.), and relay output A2 only reads out alarms from limit value monitor 2.

The individual error messages can be assigned to outputs A1 and A2 in a targeted fashion with the error masks. The values must be added and entered hexadecimally to this end. (Configuration is more user friendly with the Compact Config PC tool.)

### Device error mask (A1M2 and A2M2)

Value	Meaning	Display	default
0002	Heating current overrange	CE	A1
0004	Cold junction error	CJE	A1
0010	Heating current not off	Blinks	A1
0020	Heating current too low	Blinks	A1
0040	Heating current too high	Blinks	A1
0100	Memory error	FE	A1
0200	Parameter error	PE	A1

## Channel error mask (A1M1 and A2M1)

Wert	Meaning	Display	default
0001	Broken sensor, 2 <sup>nd</sup> input	SE H	A1
0002	Reversed polarity, 2 <sup>nd</sup> input	SE L	A1
0004	Analog error	AE	A1
0008	Broken sensor	SE H	A1
0010	Reversed polarity	SE L	A1
0020	1 <sup>st</sup> Lower limit value fallen short of	Blinks	A1
0040	2 <sup>nd</sup> lower limit value fallen short of	Blinks	A2
0080	1 <sup>st</sup> upper limit value exceeded	Blinks	A1
0100	2 <sup>nd</sup> upper limit value exceeded	Blinks	A2
0200	Parameter impermissible for entry via interface		–
0800	Heating circuit error	LE	A1
1000	Self-tuning start-up error	no t	–
2000	Self-tuning error or abort	tE X	A1

## Replacing an R2400 Controller with an R2500 Controller

### Replacement with regard to feature A

R2400			R2500			
Feature	Heating output	Cooling output	Feature	Configuration		
A1	Transistor	—	A1	Out1 = HEAt	Out2 = oFF	
A1	Relay	—	A2	Out1 = HEAt	Out2 = oFF	
A1	—	Transistor	A1	Out1 = Cool	Out2 = oFF	
A1	—	Relay	A2	Out1 = Cool	Out2 = oFF	
A2, A4	Transistor	Transistor	A1	Out1 = HEAt	Out2 = Cool	
A2, A4	Relay	Transistor	A2	Out1 = HEAt	Out2 = Cool	
A2, A4	Transistor	Relay	A2	Out1 = Cool	Out2 = HEAt Rewiring: 3 to 4 and 17 to 15	
A2, A4	Relay	Relay	A2	Out1 = HEAt Rewiring: 17 to 18	Out2 = Cool 15 to 20 19 to 16	Out = XCh 16 to 19 20 to 15
A3	Continuous	—	A5	Out1 = oFF	Cont = HEAt	
A3	—	Continuous	A5	Out1 = oFF	Cont = Cool	
A3	Continuous	Relay	A5	Out1 = Cool	Cont = HEAt Rewiring: 17 to 15	
A3	Relay	—	A5	Out1 = HEAt	Cont = Proc	
A3	—	Relay	A5	Out1 = Cool	Cont = Proc	
A3	Relay	Relay	A5	Out1 = HEAt Rewiring: 17 to 18	Out2 = Cool 15 to 20 19 to 16	Out = XCh 16 to 19 20 to 15

- When configured as a step-action controller (R2400, features A2, A4), the configuration of the corresponding output is not Outx = Cool in the case of the R2500, but rather Outx = HcLo.

### Replacement with regard to features B and C:

- Features B1 and B2 are identical for both devices.
- Features C1 and C2 for the R2400 are feature C1 for the R2500.
- Feature C3 cannot be replaced with the R2400.
- Feature C4 for the R2400 is feature C2 for the R2500.

### The following functions cannot be replaced:

- Position acknowledgement display for step-action controller (R2400, feature A4). Step-action controller function is available.
- 24 V AC auxiliary power (R2400, feature C3)

### The following rewiring is required:

- The connector terminals on the R2400 can still be used, because the pin assignments are identical except for a few exceptions. The two plug connectors can be pulled out after loosening the lacquered screws.
- In the case of 230 V AC auxiliary power (R2400, feature C1), the conductor connected to terminal 13 is moved to terminal 12.
- If the actuating signal for cooling is read out via the relay, the corresponding connection must be changed (see table on page 46).
- If both actuating signals are read out via relay, the relay connections must be changed (see table on page 46).

### Converting Parameters

In the case of the R2500, the proportional bands are specified in the unit of measure of the controlled variable, instead of as a percentage of the measuring range span as is the case with the R2400. Conversion is accomplished as follows:

$$P_b (\text{R2500}) = P_b (\text{R2400}) \times m_{rs} (\text{R2400}) / 100\%$$



#### Attention!

To ensure radio interference suppression, the protective conductor and/or control cabinet grounding **must** be connected to terminal 13.

---

## Technical Data

Ambient Conditions		
Annual mean relative humidity, no condensation		75%
Ambient temperature	Nominal range of use	0 °C ... + 50 °C
	Operating range	0 °C ... + 50 °C
	Storage range	-25 °C ... + 70 °C

Auxiliary Voltage	Nominal Range of Use		Power Consumption
Nominal Value	Voltage	Frequency	
110 V AC 230 V AC	85 to 265 V AC	48 to 62 Hz	Typically 1.5 W
24 V DC	20 to 30 V DC	–	

Relay output	Floating NO contact, common phase for switching outputs A1 and A2
Switching capacity	250 V AC/DC, 2 A, 500 VA / 50 W
Service life	> 5 • 10 <sup>5</sup> switching cycles at nominal load
Interference suppression	Utilize external RC element (100 Ω - 47 nF) at contactor

Electrical Safety	
Safety class	II, panel-mount device per DIN EN 61010-1, section 6.5.4
Fouling factor	2, per DIN EN 61010-1, section 3.7.3.1 and IEC 664
Measuring category	II, per DIN EN 61010 appendix J and IEC 664
Operating voltage	300 V per DIN EN 61010
EMC interference emission	EN 61326
EMC interference immunity	EN 61326

Refer to the data sheet for complete technical data (3-349-377-03).



# CompactConfig Configuration Tool

This software (languages: D, GB, F, I) runs under Windows 95, 98, NT4, 2000 and XP, and allows for:

- Online and offline parameter settings and configuration
- Saving and printing of data records
- Automatic generation of a wiring diagram
- Online viewing of the control process
- Read-out and storage of values from the data logger, and from alarm history
- Administration of 4 parameter sets
- Programming of the program section (8 programs with 12 segments each)

The Z250I IR adapter is required in order to use the configuration tool.

Further information regarding accessories and the latest version of the software, which can be downloaded free of charge, are available on the Internet at:  
<http://www.gossenmetrawatt.com> (→ Products → Controllers → Compact Controller → R2500)





---

Edited in Germany • Subject to change without notice • PDF version available on the Internet

 **GOSSEN METRAWATT**  
GMC-I Messtechnik GmbH  
Südwestpark 15  
90449 Nürnberg • Germany

Phone +49 911 8602-111  
Fax +49 911 8602-777  
E-Mail [info@gossenmetrawatt.com](mailto:info@gossenmetrawatt.com)  
[www.gossenmetrawatt.com](http://www.gossenmetrawatt.com)